

datavideo®

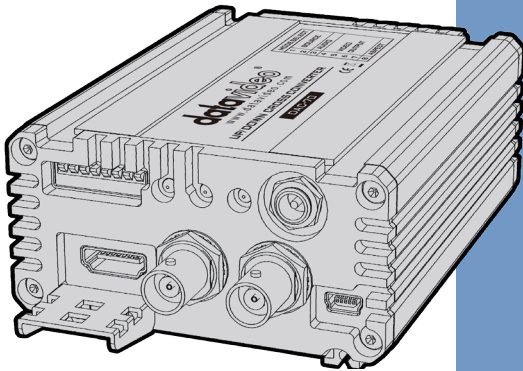

**UP / DOWN / CROSS
CONVERTER
DAC-70**

Instruction Manual

www.datavideo.com

Welcome to the DAC-70 Instruction Manual



Thank you for choosing a Datavideo product, please visit the support pages on our website for the latest version of the instruction manual.

<http://www.datavideo.info/Converters/DAC-70>

Don't forget to register your product online to qualify for an additional free one year extension to the standard warranty, and to receive information from Datavideo on service & information relevant to your Datavideo product including new software updates & drivers

Warranty

Standard Warranty

- Datavideo equipment is guaranteed against any manufacturing defects for one year from the date of purchase.
- The original purchase invoice or other documentary evidence should be supplied at the time of any request for repair under warranty.
- Damage caused by accident, misuse, unauthorized repairs, sand, grit or water is not covered by this warranty.
- All mail or transportation costs including insurance are at the expense of the owner.
- All other claims of any nature are not covered.
- Cables & batteries are not covered under warranty.
- Warranty only valid within the country or region of purchase.
- Your statutory rights are not affected.

Two Year Warranty



- All Datavideo products purchased after 01-Oct.-2008 qualify for a free one year extension to the standard Warranty, providing the product is registered with Datavideo within 30 days of purchase. For information on how to register please visit www.datavideo.com or contact your local Datavideo office or authorized Distributors
- Certain parts with limited lifetime expectancy such as LCD Panels, DVD Drives, Hard Drives are only covered for the first 10,000 hours, or 1 year (whichever comes first).

Any second year warranty claims must be made to your local Datavideo office or one of its authorized Distributors before the extended warranty expires.

Contents

Welcome to the DAC-70 Instruction Manual	2
Warranty	2
Standard Warranty	2
Two Year Warranty	2
Disposal	4
Warnings and Precautions	4
Packing List	5
Introduction	6
Features	6
Video Inputs	6
Audio Inputs	6
Video outputs	6
Control	6
Front Panel	7
Rear Panel	8
MINI Switch Mode Selection	9
How to update the DAC-70 firmware	10
DAC-70 Center Utility features	11
Dimensions	14
Specifications	15
Service & Support	16

Disclaimer of Product and Services

The information offered in this instruction manual is intended as a guide only. At all times, Datavideo Technologies will try to give correct, complete and suitable information. However, Datavideo Technologies cannot exclude that some information in this manual, from time to time, may not be correct or may be incomplete. This manual may contain typing errors, omissions or incorrect information. Datavideo Technologies always recommend that you double check the information in this document for accuracy before making any purchase decision or using the product. Datavideo Technologies is not responsible for any omissions or errors, or for any subsequent loss or damage caused by using the information contained within this manual. Further advice on the content of this manual or on the product can be obtained by contacting your local Datavideo Office or dealer.

Disposal



For EU Customers only - WEEE Marking

This symbol on the product indicates that it will not be treated as household waste. It must be handed over to the applicable take back scheme for the recycling of electrical and electronic equipment. For more detailed information about the recycling of this product, please contact your local Datavideo office.

Warnings and Precautions

1. Read all of these warnings and save them for later reference.
2. Follow all warnings and instructions marked on this unit.
3. Unplug this unit from the wall outlet before cleaning. Do not use liquid or aerosol cleaners. Use a slightly damp cloth for cleaning.
4. Do not use this unit in or near water.
5. Do not place this unit on an unstable surface, cart, stand, or table. The unit may fall, causing serious damage.
6. Any slots and openings on the case top, back, and bottom are provided for ventilation. To ensure safe and reliable operation of this unit, and to protect it from overheating, do not block or cover these openings. Do not place this unit on a bed, sofa, rug, or similar surface, as the ventilation openings may become blocked. This unit should never be placed near or over a heat source or radiator. This unit should not be placed in a built-in installation unless proper ventilation is provided.
7. This product should only be operated from the type of power source indicated on the marking label of the AC adapter. If you are not sure of the type of power available, consult your Datavideo dealer or your local power company.
8. Do not allow anything to rest on the power cord. Do not locate this unit where the power cord will be walked on, rolled over, damaged or otherwise stressed.
9. If an extension cord must be used with this unit, make sure that the total of the ampere ratings on the products plugged into the extension cord do not exceed the extension cord's rating.
10. Make sure that the total amperes of all the units that are plugged into a single wall outlet do not exceed 15 amperes.
11. Never push objects of any kind into this unit through the case ventilation slots, as they may touch dangerous voltage points or short out parts that could result in risk of fire or electric shock. Never spill liquid of any kind onto or into this unit.
12. Except as specifically explained elsewhere in this manual, do not attempt

to service this product yourself. Opening or removing covers that are marked “Do Not Remove” may expose you to dangerous voltage points or other risks, and will void your warranty. Refer all service issues to qualified service personnel.

13. Unplug this product from the wall outlet and refer to qualified service personnel under the following conditions:
 - a. When the power cord is damaged or frayed;
 - b. When liquid has spilled into the unit;
 - c. When the product has been exposed to rain or water;
 - d. When the product does not operate normally under normal operating conditions. Adjust only those controls that are covered by the operating instructions in this manual; improper adjustment of other controls may result in damage to the unit and may often require extensive work by a qualified technician to restore the unit to normal operation;
 - e. When the product has been dropped or the case has been damaged;
 - f. When the product exhibits a distinct change in performance, indicating a need for service.

Packing List

Items	Description	Q'ty
1	DAC-70 Converter	1
2	Instruction Manual	1
3	Accessory List	1

Introduction

The Datavideo DAC-70 is a broadcast quality, set and forget, up-down-cross converter. The unit offers simple mini switch controls and/or a flexible USB 2.0 interface. Whilst the DAC-70 case LEDs quickly confirm, DC power input, source selection and detection. The DAC-70 makes it easy to share VGA or HDMI or SDI inputs within your chosen HDMI or SDI workflow.

Housed in a rugged case, the DAC-70 is tough enough to meet the knocks of fast paced set ups in ENG, studio or live production work. Built to the same dimensions as Datavideo's range of converters, the DAC-70 can also be mounted into a standard 19" rack with a mix of other units when using the RMK-2 module.

That's Datavideo, sharing the value!

Features

- Supports 3G-SDI technology with full 10 bit processing and low SDI jitter
- DC or AC operation for convenient field or studio use
- Quick and easy mini switch setup
- Micro USB 2.0 interface for easy firmware updates

Video Inputs - Choose from:

- HD / SD-SDI [BNC] with active SDI loop through
- HDMI
- VGA [15pin D-Sub Female]

Audio Inputs

- Supports HDMI / SDI embedded multi-channel audio
- Unbalanced RCA Phono sockets [Stereo L&R Chls @ line level]

Video outputs

- Two HD / SD-SDI [BNC] with embedded audio
- HDMI with embedded audio
- HDMI & SDI outputs are active at the same time regardless of setting

Control

- Windows only software utility for local configuration and control via Micro USB 2.0 interface

Note: The DAC-70 supports HDCP copy protection. When you supply protected DVD or BD video the DAC-70 will output no signal.

Front Panel

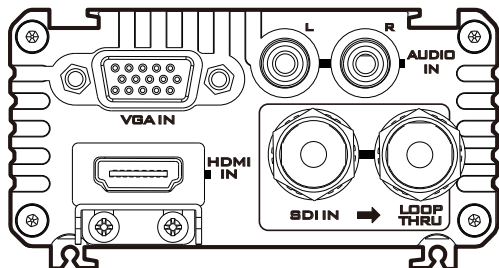

Video In

Connects your VGA connector equipment to this connector

Supported resolutions

800x600	@60Hz,	1024x768	@60Hz,
1280x1024	@60Hz,	1366x768	@60Hz,
1400x1050	@60Hz,	1600x1200	@60Hz



HDMI In

Connects your HDMI connector equipment to this connector

HDCP Copy Protection

For legal reasons the HDMI input is unable to pass on video from copy protected HDMI sources.



Audio In

Inputs for 2 channels RCA unbalanced audio



HD-SDI In & Output (Loop Thru)

HD-SDI input and Loop-through output connectors.

Rear Panel

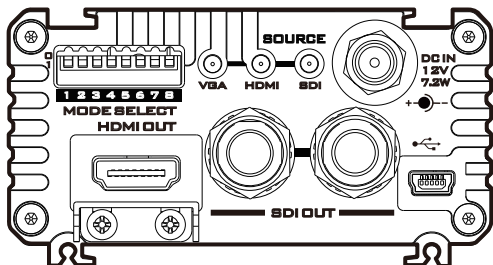

Mode Select (Mini switch)

Use these Mini switches to manually set the DAC-70 mode, see table on page 9.

The unit can also be set up by Windows computer over USB 2.0 cable, see page 11.



Source Indicator

Displays video source format.



HDMI OUT

Video and Audio output from HDMI.



HD/SD - SDI OUT

Video and Audio output from SDI.



DC In Socket

Connects the supplied 12V PSU to this socket. The connection can be secured by screwing the outer fastening ring of the DC In plug to the socket.



USB

Firmware upgrade/ Function control by DAC-Center

MINI Switch Mode Selection

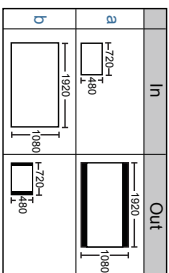
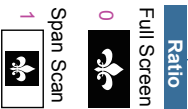
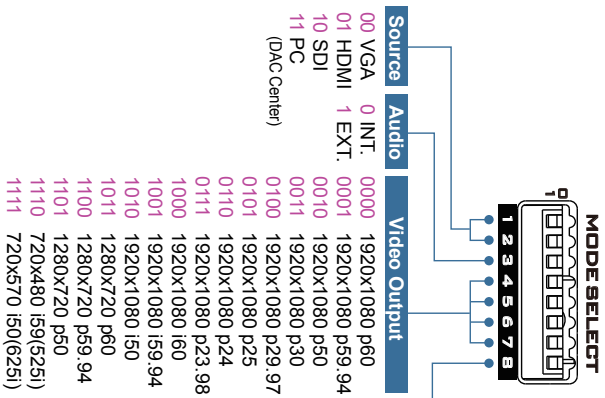

Mini Switch Pin 8 Up: Full Screen
Mini Switch Pin 8 Down: Span Scan 16:9

Span Scan 16:9

Input 4:3, output 16:9

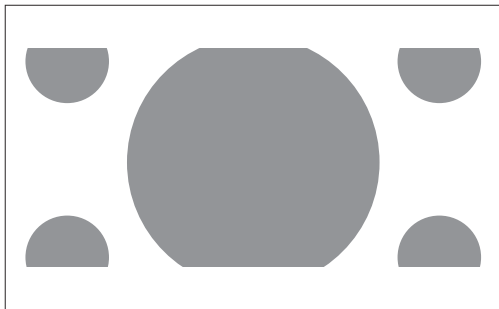

Input 16:9, output 4:3

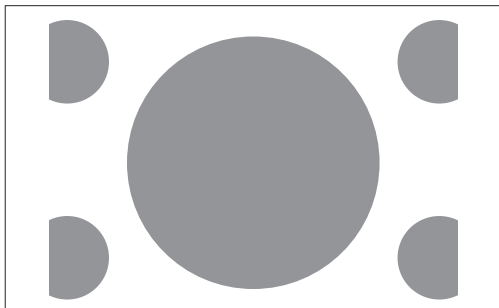

How to update the DAC-70 firmware

From time to time Datavideo may release new firmware to either add new features or to fix reported bugs in the current DAC-70 firmware. Customers can update the DAC-70 firmware themselves or they can contact their local dealer for assistance.

This section describes the firmware update process and it should take **approximately 10 minutes total time to complete**.

The current DAC-70 settings should be noted. Once started *the update process should not be interrupted* as this could result in a non-responsive unit.

As well as a working DAC-70 you will need:

1. The latest update file for the DAC-70. This can be obtained from your local Datavideo dealer or office.
2. The Upload Firmware utility. This can also be obtained from your local Datavideo dealer or office.
3. A Windows computer with USB 2.0 port.
4. A USB 2.0 - USB A to micro USB cable.

How to update the DAC-70

1. **Switch off the power to the DAC-70.**
2. Save the **firmware update** file and **Upload Firmware utility** to the desktop of your Windows computer so they are easy to locate.

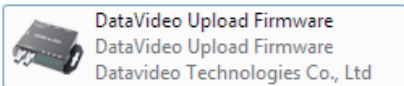

3. Connect the USB 2.0 cable between the DAC-70 and the computer.
4. Launch the Datavideo Upload Firmware utility. It will show **Disconnected** and the connect button will be greyed out.
5. Now switch on the power to the DAC-70. The connect button will now be available to click. Once you clicked the Utility, it will now show **Connected**.
6. Click the Open File button and select the update file.
7. Click the Start button and wait for the progress bar to finish.
8. When finishing the utility it will confirm **PASS** if the unit has been updated successfully.
9. The utility will automatically disconnect the DAC-70 unit.
10. Remove the USB cable from the DAC-70 and power cycle of the unit.
11. The DAC-70 is now ready for use again.

DAC-70 Center Utility features

Please copy the **DAC-70 Center.exe** utility software from the supplied CD to your Windows computer. Now connect the DAC-70 by USB cable to the same computer. Switch on the DAC-70 and then launch the DAC-70 Center utility software.

1. Click on the **Information tab** to display the input format & firmware version.

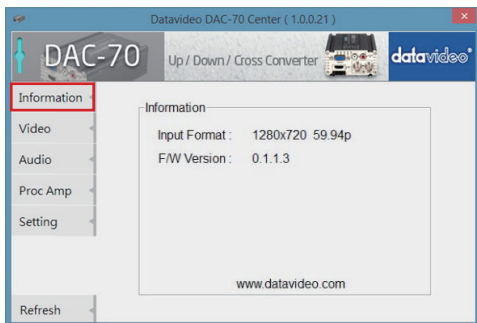

- 2.1 Click on the **Video tab** to enter the video setup.

- 2.2 Set the input source, aspect ratio and output format **then click Apply**.

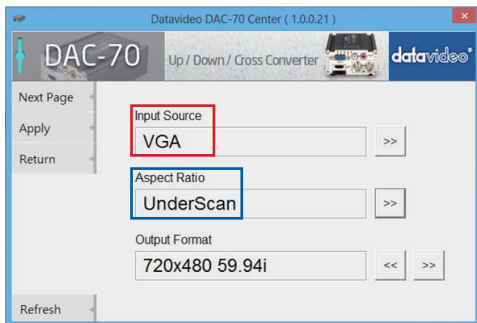

Note1: When “Input Source” set on “VGA“, the **Image Adjust** can set Horizontal Position & Vertical Position.

Horizontal Position	+	-
Vertical Position	+	-

Note2: When “Aspect Ratio” set on “Under Scan“, the **Image Adjust** can set Horizontal Size & Vertical Size.

Horizontal Size	+	-
Vertical Size	+	-

2.3 Click **Next Page** to set the HDMI output colour & output range **then** click **Apply**.

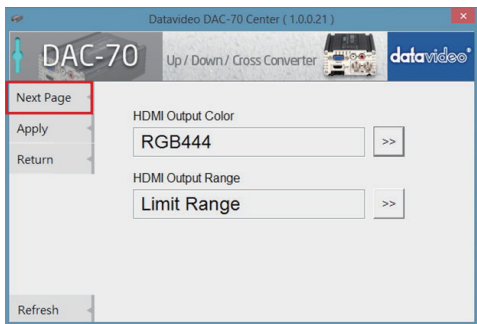

3.1 Click the **Audio tab** to set the audio parameters.

3.2 Set the audio mute, audio source & audio level **then click Apply**.

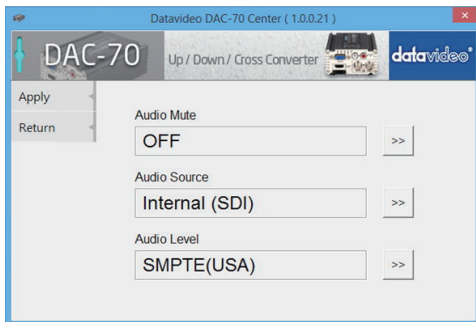

Note 1: Audio Level can also be switched between EBU and SMPTE standards.

Note 2: Audio Level setting only for RCA input.

4.1 Click the **Proc AMP tab** to adjust the picture settings.

4.2 Set the Brightness, Contrast, Hue, and Saturation level.

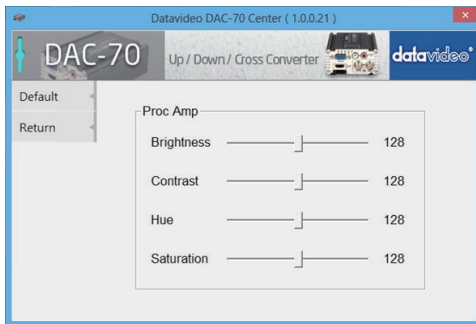

- 5.1 Click the **Setting tab** to access the restore factory defaults window.
- 5.2 Click the **Factory Default button** to reset the DAC-70 to factory defaults.

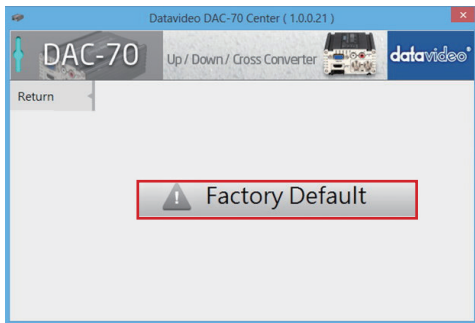

Dimensions

All measurements in mm

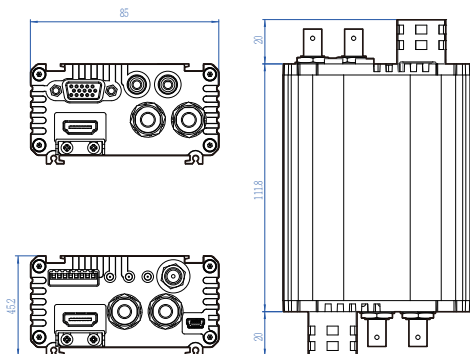

Specifications

Input	VGA x 1, HDMI x 1 , HD/SD-SDI x 1, Analog Audio L/R
Output	SDI x 2, HDMI x 1, SDI Loop thru BNC(front panel)
Mini USB	<ul style="list-style-type: none"> ● Firmware upgrade ● Aspect Mode selection
Supported Video Input Format	<ul style="list-style-type: none"> ● SDI (YUV) input 3G-SDI: 1080p60/50 1080p59.94 HD-SDI: 1080i60/50, 1080p30/25/24, 720p60/50 1080i59.94, 1080p29.97, 1080p23.98, 720p59.94 ● SD-SDI(YUV): 525i, 625i ● HDMI(YUV/RGB): 1080p60/50, 1080i60/50, 1080p30/25/24, 720p60/50 1080p59.94, 1080i59.94, 720p59.94, 1080p29.97 1080p23.98, 480p, 576p 800x600@60Hz, 1024x768@60Hz, 1280x1024@60Hz 1366x768@60Hz, 1400x1050@60Hz, 1600x1200@60Hz ● VGA: 800x600@60Hz, 1024x768@60Hz, 1280x1024@60Hz 1366x768@60Hz, 1400x1050@60Hz, 1600x1200@60Hz ● HDMI Supports YUV / RGB color space
Supported Video Output Format	SDI / HDMI 1080p60/50, 1080p59.94, 1080p23.98/29.97/24/25/30 1080i60/50 ; 720P60/50 1080i59.94 ; 720P59.94, 525i, 625i ● SDI/HDMI output supports YUV 4:2:2
Supported Audio Format	<ul style="list-style-type: none"> ● Input Analog Audio L/R : stereo audio SDI / HDMI embedded audio up to 8CH, 48KHz, PCM audio HDMI embedded audio: up to 8CH, 44.1/48/96KHz, PCM audio ● Output SDI embedded audio up to 8CH, 48KHz, PCM audio HDMI embedded audio: up to 8CH, 48KHz, PCM audio
Power Consumption	12V/1A (7.2W)
Operating Temperature	0~50°C [32~114°F]
Storage Temperature	-10~ +60°C
Dimension	144.8mm(L) x 85mm(W) x 45.2mm(H)
Certifications	CE / FCC

Notes

Service & Support

It is our goal to make your products ownership a satisfying experience. Our supporting staff is available to assist you in setting up and operating your system. Please refer to our web site www.datavideo.com for answers to common questions, support requests or contact your local office below.

Datavideo USA

Datavideo Corporation
7048 Elmer Avenue.
Whittier, CA 90602,
U.S.A.
Tel: +1-562-696 2324
Fax: +1-562-698 6930
E-mail: sales@datavideo.us

Datavideo Europe

Datavideo Technologies Europe BV
Floridadreef 106
3565 AM Utrecht,
The Netherlands
Tel: +31-30-261-96-56
Fax: +31-30-261-96-57
E-mail: info@datavideo.nl

Datavideo United Kingdom

Datavideo UK Limited
Units1 & 2 Waterside Business Park
Hadfield, Glossop, Derbyshire
SK13 1BE, UK
Tel: +44-1457 851 000
Fax: +44-1457 850 964
E-mail: sales@datavideo.co.uk

Datavideo Taiwan

Datavideo Technologies Co. Ltd
10F, No. 176, Jian 1st Rd., Chung Ho
District, New Taipei City 235, Taiwan,
R.O.C.
Tel: +886-2-8227-2888
Fax: +886-2-8227-2777
E-mail: service@datavideo.com.tw

Datavideo China

Datavideo Technologies China Co
101, NO. 618, LiuYing Rd, Zhabei District,
Shanghai, China
Tel: +86 21-5603 6599
Fax: +86 21-5603 6770
E-mail: service@datavideo.cn

Datavideo Singapore

Datavideo Technologies (S) PTE Ltd
No. 178 Paya Lebar Road #06-03
Singapore 409030
Tel: +65-6749 6866
Fax: +65-6749 3266
E-mail: sales@datavideo.sg

Datavideo Hong Kong

Datavideo Hong Kong Ltd
G/F., 26 Cross Lane
Wanchai, Hong Kong
Tel: +852-2833-1981
Fax: +852-2833-9916
E-mail: info@datavideo.com.hk

Datavideo France

Datavideo France s.a.r.l
Cité Descartes 1, rue Albert Einstein
Champs sur Marne
774477-Marne la Vallée cedex 2
Tel: +33-1-60370246
E-mail: info@datavideo.fr

Datavideo India

Datavideo Technologies India Pvt L
A-132, Sec-63, Noida-201307,
Uttar Pradesh (UP), India.
Tel: +91-0120-2427337
Fax: +91-0120-2427338
E-mail: sales@datavideo.in

datavideo®
www.datavideo.com

All the trademarks are the properties of their respective owners.
Datavideo Technologies Co., Ltd. All rights reserved 2013

Aug.19.2014 P/N: G082060577E3