

Up / Down Cross Converter

DAC-70



Quick Start Guide

www.datavideo.com

Table of Contents

Warnings and Precautions	2
Packing List	4
Introduction	4
Features	4
Functions	5
Front Panel	5
Rear Panel	6
DIP Switch Mode Selection:	7
Firmware Upgrade	8
DAC-Center Utility	9
Dimensions	14
Specifications	15
Service & Support	16

Warnings and Precautions

1. Read all of these warnings and save them for later reference.
2. Follow all warnings and instructions marked on this unit.
3. Unplug this unit from the wall outlet before cleaning. Do not use liquid or aerosol cleaners. Use a damp cloth for cleaning.
4. Do not use this unit in or near water.
5. Do not place this unit on an unstable cart, stand, or table. The unit may fall, causing serious damage.
6. Slots and openings on the cabinet top, back, and bottom are provided for ventilation. To ensure safe and reliable operation of this unit, and to protect it from overheating, do not block or cover these openings. Do not place this unit on a bed, sofa, rug, or similar surface, as the ventilation openings on the bottom of the cabinet will be blocked. This unit should never be placed near or over a heat register or radiator. This unit should not be placed in a built-in installation unless proper ventilation is provided.
7. This product should only be operated from the type of power source indicated on the marking label of the AC adapter. If you are not sure of the type of power available, consult your Datavideo dealer or your local power company.
8. Do not allow anything to rest on the power cord. Do not locate this unit where the power cord will be walked on, rolled over, or otherwise stressed.
9. If an extension cord must be used with this unit, make sure that the total of the ampere ratings on the products plugged into the extension cord do not exceed the extension cord's rating.
10. Make sure that the total amperes of all the units that are plugged into a single wall outlet do not exceed 15 amperes.
11. Never push objects of any kind into this unit through the cabinet ventilation slots, as they may touch dangerous voltage points or short out parts that could result in risk of fire or electric shock. Never

- spill liquid of any kind onto or into this unit.
12. Except as specifically explained elsewhere in this manual, do not attempt to service this product yourself. Opening or removing covers that are marked “Do Not Remove” may expose you to dangerous voltage points or other risks, and will void your warranty. Refer all service issues to qualified service personnel.
 13. Unplug this product from the wall outlet and refer to qualified service personnel under the following conditions:
 - a. When the power cord is damaged or frayed;
 - b. When liquid has spilled into the unit;
 - c. When the product has been exposed to rain or water;
 - d. When the product does not operate normally under normal operating conditions. Adjust only those controls that are covered by the operating instructions in this manual; improper adjustment of other controls may result in damage to the unit and may often require extensive work by a qualified technician to restore the unit to normal operation;
 - e. When the product has been dropped or the cabinet has been damaged;
 - f. When the product exhibits a distinct change in performance, indicating a need for service.
 14. Due to the general consumer usage behavior, efficient power distribution on the field, corporate environment responsibility by eliminating harmful substances such as carbon dioxide, sulphur dioxide, etc, and other unexpected risks, this product does not provide standby power option.

Packing List

The following items should be included in the box. If any items are missing please contact your supplier.

- 1 x Accessory Note
- 1 x Quick Start Guide

Introduction

Datavideo DAC-70 up/ down cross converter is for conversation between SD and HD video formats. It allows instantly switch between SD and HD video formats automatically when the video input changes. Compatible with the advanced 3GB/s SDI, the converter includes a built-in mini-USB connection for future updates and video format compatibility.

Features

- Includes full up, down, and cross conversion between HD and SD video formats.
- Support 3 GB/s SDI Technology
- Full 10-bit processing with high-quality video filtering
- Built with high-quality standards and low SDI jitter to get longest SDI cable lengths
- Supports multi-channel audio (SDI 8 ch audio embedded)
- Mini USB port for F/W upgrade ; Aspect ratio configuration.

Functions

Front Panel

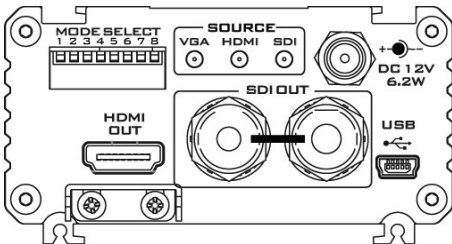

Mode Select

Video source, audio source, output video format & aspect ratio select.

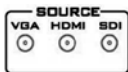

Source Indicator

Display video source format.

HDMI



HDMI OUT

Video and Audio output from HDMI.



HD/SD - SDI OUT

Video and Audio output from SDI.

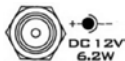

DC In Socket

Connect the supplied 12V PSU to this socket. The connection can be secured by screwing the outer fastening ring of the DC In plug to the socket.

USB



USB

Firmware upgrade/ Function control by DAC-Center

Rear Panel

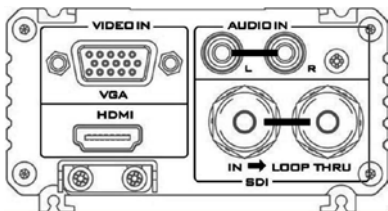

VGA

Video In

Connect your VGA equipment to this connector



HDMI

HDMI Input

Video and Audio input from HDMI.



AUDIO In

2 channels RCA unbalanced audio input.

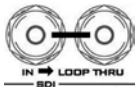

HD-SDI In

HD - SDI input and Loop-through output connectors.

DIP Switch Mode Selection:

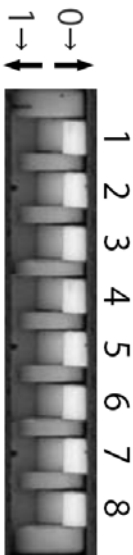

Source	Audio	Video Output
00 VGA	0 INT.	0000 1920x1080 p60
01 HDMI	1 EXT.	0001 1920x1080 p59.94
10 SDI		0010 1920x1080 p50
11 N/A		0011 1920x1080 p30
		0100 1920x1080 p29.97
		0101 1920x1080 p25
		0110 1920x1080 p24
		0111 1920x1080 p23.98
		1000 1920x1080 i60
		1001 1920x1080 i59.94
		1010 1920x1080 i50
		1011 1280x720 p60
		1100 1280x720 p59.94
		1101 1280x720 p50
		1110 720x480 i59 (525i)
		1111 720x570 i50 (625i)

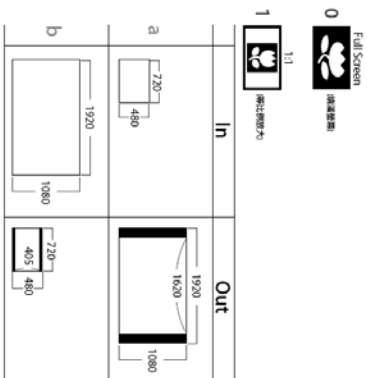

Firmware Upgrade

If you need update DAC-70's firmware please check the **User Adjust Tool** CD or you can link www.datavideo.com download the tools.

Firmware is upgradable in the field using the integrated USB port.

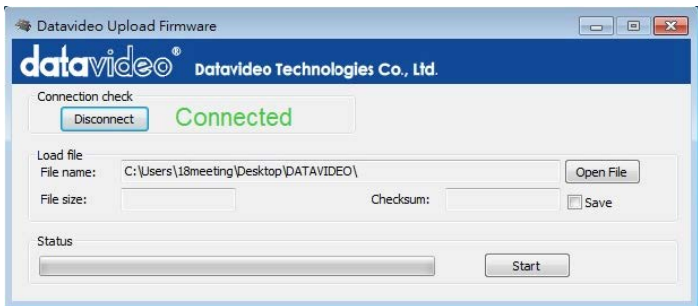

Step 1 - Open upload firmware program tools.exe, connect unit to PC by USB cable and turn off power

Step 2 - Turn on power

Step 3 - Turn off power and back on again to reset unit and select firmware.

Step 4 - Press start button to update the firmware

Step 5 - Close upload firmware program tools

DAC-Center Utility

Settings the video source, audio source, picture adjusts...etc.

Please copy "DAC-70 Center.exe" tool from "User Adjust Tool" CD before you setting.

1. Information – display the input format & firmware version.

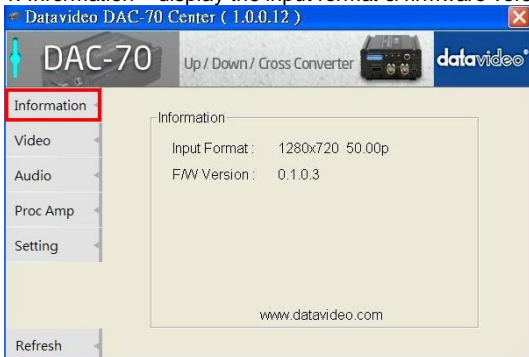

2.1 Press "Video" to setting the video source.



2.2 Setting the input source, aspect ratio, output format.



2.3 Setting the HDMI output color, HDMI output range.



3.1 Press "Audio" to setting the audio source.



3.2 Setting the audio mute, audio source & audio level

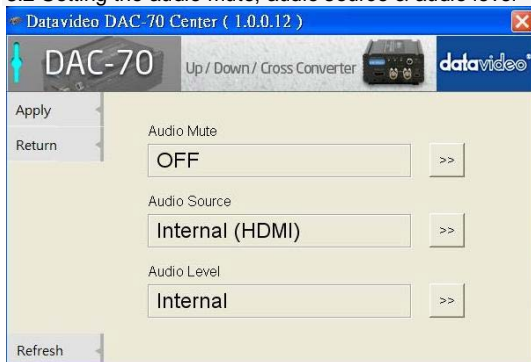

4.1 Press "Proc AMP" to setting the picture adjusts.



4.2 Setting the Brightness, Contrast, Hue and Saturation values.

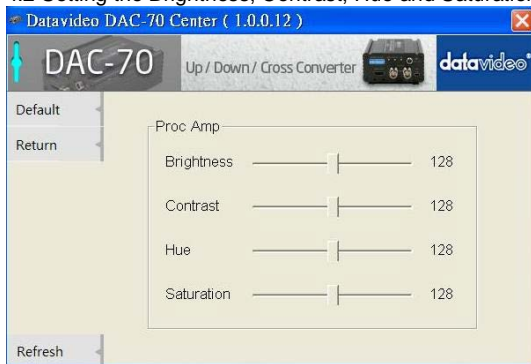

5.1 Press "Setting" into the factory default window.



5.2 Press "Factory Default", reset the DAC-70 to factory default.

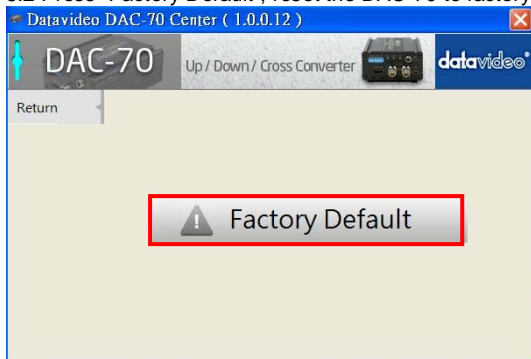

Dimensions

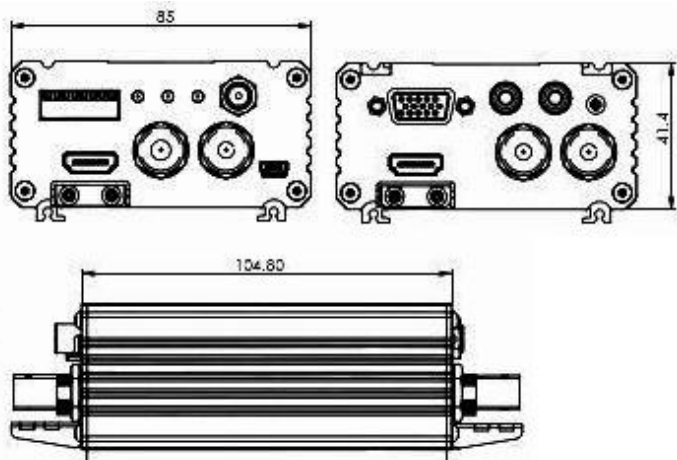

Specifications

Input	VGA x 1, HDMI x 1 , HD/SD-SDI x 1, Analog Audio L/R
Output	SDI x 2, HDMI x 1, SDI Loop thru out(front panel)
Mini USB	<ul style="list-style-type: none"> ● Firmware upgrade ● Aspect Mode selection
Supported Video Input Format	<ul style="list-style-type: none"> ● SDI (YUV) input 3G-SDI: 1080p60/50 1080p59.94 HD-SDI: 1080i60/50, 1080p30/25/24, 720p60/50 1080i59.94, 1080p29.97, 1080p23.98, 720p59.94 ● SD-SDI(YUV): 525i, 625i ● HDMI(YUV/RGB): 1080p60/50, 1080i60/50, 1080p30/25/24, 720p60/50 1080p59.94, 1080i59.94, 720p59.94, 1080p29.97 1080p23.98, 480p, 576p 800x600@60Hz, 1024x768@60Hz, 1280x1024@60Hz 1366x768@60Hz, 1400x1050@60Hz, 1600x1200@60Hz ● VGA: 800x600@60Hz, 1024x768@60Hz, 1280x1024@60Hz 1366x768@60Hz, 1400x1050@60Hz, 1600x1200@60Hz ● HDMI Supports YUV / RGB color space
Supported Video Output Format	<ul style="list-style-type: none"> ● SDI / HDMI 1080p60/50, 1080p59.94, 1080p23.98/29.97/24/25/30 1080i60/50 ; 720P60/50 1080i59.94 ; 720P59.94, 525i, 625i ● SDI/HDMI output supports YUV 4:2:2
Supported Audio Format	<ul style="list-style-type: none"> ● Input Analog Audio L/R : stereo audio SDI / HDMI embedded audio up to 8CH, 48KHz, PCM audio HDMI embedded audio: up to 8CH, 44.1/48/96KHz, PCM audio ● Output SDI embedded audio up to 8CH, 48KHz, PCM audio HDMI embedded audio: up to 8CH, 48KHz, PCM audio
Power Consumption	12V/1A (6.2W)
Operating Temperature	0~50°C [32~114°F]
Storage Temperature	-10~ +60°C
Dimension	127.1mm(L) x 85mm(W) x 45.2mm(H)
Certifications	CE / FCC

Service & Support

It is our goal to make your products ownership a satisfying experience. Our supporting staff is available to assist you in setting up and operating your system. Please refer to our web site www.datavideo-tek.com for answers to common questions, support requests or contact your local office below.

Datavideo Global Website: www.datavideo-tek.com

Datavideo Corporation

Tel: +1 562 696 2324	Fax: +1 562-698-6930	E-Mail: contactus@datavideo.us
----------------------	----------------------	--

Datavideo Technologies Europe BV

Tel: +31-30-261-96-56	Fax: +31-30 261-96-57	E-Mail: service@datavideo.nl
-----------------------	-----------------------	--

Datavideo UK Limited

Tel: +44 1457 851 000	Fax: +44 1457 850 964	E-Mail: sales@datavideo.co.uk
-----------------------	-----------------------	--

Datavideo Technologies Co., Ltd

Tel: +886 2 8227 2888	Fax: +886-2-8227-2777	E-mail: service@datavideo.com.tw
-----------------------	-----------------------	--

Datavideo Technologies China Co., Ltd

Tel: +86 21-5603 6599	Fax: +86 21-5603 6770	E-mail: service@datavideo.cn
-----------------------	-----------------------	--

Datavideo Technologies (S) PTE LTD

Tel: +65-6749 6866	Fax: +65-6749 3266	E-mail: service@datavideo.sg
--------------------	--------------------	--

Datavideo HK Limited

Tel: +852 2833 1981	Fax: +852-2833-9916	E-mail: info@datavideo.com.hk
---------------------	---------------------	--

Datavideo France

Tel: +33 1 60 37 02 46	Fax: +33 1 60 37 67 32	E-Mail: info@datavideo.fr
------------------------	------------------------	--

Datavideo India

Tel: +91-0120-2427337	Fax: +91-0120-2427338	E-Mail: sales@datavideo.in
-----------------------	-----------------------	--

All the trademarks are the properties of their respective owners.
Datavideo Technologies Co., Ltd. All rights reserved 2018