

# datavideo

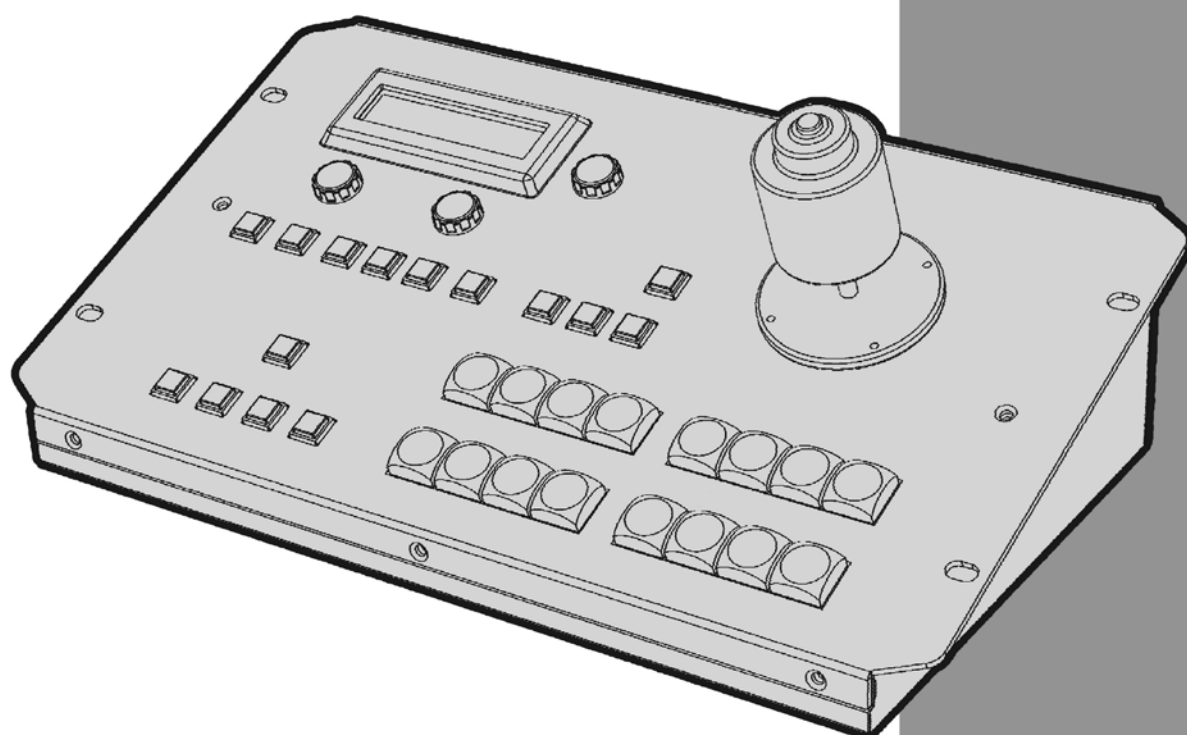

## **KMU CONTROLLER RMC-185 Instruction manual**

[www.datavideo.com](http://www.datavideo.com)

## Table of Contents

<b>FCC COMPLIANCE STATEMENT</b> .....	<b>3</b>
<b>WARNINGS AND PRECAUTIONS</b> .....	<b>3</b>
<b>WARRANTY</b> .....	<b>4</b>
STANDARD WARRANTY .....	4
TWO YEAR WARRANTY .....	4
<b>DISPOSAL</b> .....	<b>4</b>
<b>1. INTRODUCTION</b> .....	<b>5</b>
1.1 FEATURES .....	5
1.2 DEVICE SETUP .....	5
<b>2. CONNECTIONS AND CONTROLS</b> .....	<b>6</b>
2.1 FRONT PANEL – KEYBOARD .....	6
2.2 REAR PANEL - CONNECTIONS .....	8
<b>3. MENU SETUP</b> .....	<b>9</b>
FN1. EXITS THE MENU (EXIT) .....	10
FN2. INPUT A SOURCE ASSIGNMENT (INPUT B SOURCE) .....	10
FN3. INPUT B SOURCE ASSIGNMENT (INPUT B SOURCE) .....	10
FN4. OUTPUT FORMAT SELECTION (OUTPUT FORMAT) .....	10
FN5. GENLOCK SETTING (GENLOCK SET) .....	11
FN6. GENLOCK STATUS DISPLAY (GENLOCK STATUS) .....	11
FN7. SELECTION OF SDI 3G TYPE (SDI 3G TYPE) .....	11
FN8. HDMI MULTIVIEWER SWAP (MULTI. SWAP) .....	11
FN9. SDI 4 MULTIVIEWER (MULTI. SDI) .....	11
FN10. EXTERNAL MOTION TRIGGER SETTING (TRIGGER SET) .....	11
FN11. KMU-100 FIRMWARE VERSION DISPLAY (KMU-100 VER.) .....	11
FN12. DISPLAY OF KMU-100 FPGA AND PCB BOARD TEMPERATURES (KMU-100 TEMP) .....	11
FN13. RMC-185 FIRMWARE VERSION DISPLAY (FIRMWARE VER.) .....	11
<b>4. STORING DIFFERENT DEVICE SETTINGS</b> .....	<b>12</b>
<b>5. FIRMWARE UPGRADE PROCEDURE</b> .....	<b>13</b>
<b>6. FREQUENTLY-ASKED QUESTIONS</b> .....	<b>16</b>
<b>7. DIMENSIONS</b> .....	<b>17</b>
<b>8. SPECIFICATIONS</b> .....	<b>17</b>
<b>SERVICE AND SUPPORT</b> .....	<b>18</b>

### Disclaimer of Product and Services

The information offered in this instruction manual is intended as a guide only. At all times, Datavideo Technologies will try to give correct, complete and suitable information. However, Datavideo Technologies cannot exclude that some information in this manual, from time to time, may not be correct or may be incomplete. This manual may contain typing errors, omissions or incorrect information. Datavideo Technologies always recommend that you double check the information in this document for accuracy before making any purchase decision or using the product. Datavideo Technologies is not responsible for any omissions or errors, or for any subsequent loss or damage caused by using the information contained within this manual. Further advice on the content of this manual or on the product can be obtained by contacting your local Datavideo Office or dealer.

## FCC Compliance Statement

This device complies with part 15 of the FCC rules. Operation is subject to the following two conditions:

1. This device may not cause harmful interference, and
2. This device must accept any interference received, including interference that may cause undesired operation.

## Warnings and Precautions



1. Read all of these warnings and save them for later reference.
2. Follow all warnings and instructions marked on this unit.
3. Unplug this unit from the wall outlet before cleaning. Do not use liquid or aerosol cleaners. Use a damp cloth for cleaning.
4. Do not use this unit in or near water.
5. Do not place this unit on an unstable cart, stand, or table. The unit may fall, causing serious damage.
6. Slots and openings on the cabinet top, back, and bottom are provided for ventilation. To ensure safe and reliable operation of this unit, and to protect it from overheating, do not block or cover these openings. Do not place this unit on a bed, sofa, rug, or similar surface, as the ventilation openings on the bottom of the cabinet will be blocked. This unit should never be placed near or over a heat register or radiator. This unit should not be placed in a built-in installation unless proper ventilation is provided.
7. This product should only be operated from the type of power source indicated on the marking label of the AC adapter. If you are not sure of the type of power available, consult your Datavideo dealer or your local power company.
8. Do not allow anything to rest on the power cord. Do not locate this unit where the power cord will be walked on, rolled over, or otherwise stressed.
9. If an extension cord must be used with this unit, make sure that the total of the ampere ratings on the products plugged into the extension cord do not exceed the extension cord rating.
10. Make sure that the total amperes of all the units that are plugged into a single wall outlet do not exceed 15 amperes.
11. Never push objects of any kind into this unit through the cabinet ventilation slots, as they may touch dangerous voltage points or short out parts that could result in risk of fire or electric shock. Never spill liquid of any kind onto or into this unit.
12. Except as specifically explained elsewhere in this manual, do not attempt to service this product yourself. Opening or removing covers that are marked "Do Not Remove" may expose you to dangerous voltage points or other risks, and will void your warranty. Refer all service issues to qualified service personnel.
13. Unplug this product from the wall outlet and refer to qualified service personnel under the following conditions:
  - a. When the power cord is damaged or frayed;
  - b. When liquid has spilled into the unit;
  - c. When the product has been exposed to rain or water;
  - d. When the product does not operate normally under normal operating conditions. Adjust only those controls that are covered by the operating instructions in this manual; improper adjustment of other controls may result in damage to the unit and may often require extensive work by a qualified technician to restore the unit to normal operation;
  - e. When the product has been dropped or the cabinet has been damaged;
  - f. When the product exhibits a distinct change in performance, indicating a need for service.

## Warranty

### Standard Warranty

- Datavideo equipment is guaranteed against any manufacturing defects for one year from the date of purchase.
- The original purchase invoice or other documentary evidence should be supplied at the time of any request for repair under warranty.
- Damage caused by accident, misuse, unauthorized repairs, sand, grit or water is not covered by this warranty.
- All mail or transportation costs including insurance are at the expense of the owner.
- All other claims of any nature are not covered.
- Cables & batteries are not covered under warranty.
- Warranty only valid within the country or region of purchase.
- Your statutory rights are not affected.

### Two Year Warranty

- All Datavideo products purchased after 01-Oct.-2008 qualify for a free one year extension to the standard Warranty, providing the product is registered with Datavideo within 30 days of purchase. For information on how to register please visit [www.datavideo.com](http://www.datavideo.com) or contact your local Datavideo office or authorized Distributors.
- Certain parts with limited lifetime expectancy such as LCD Panels, DVD Drives, Hard Drives are only covered for the first 10,000 hours, or 1 year (whichever comes first).



Any second year warranty claims must be made to your local Datavideo office or one of its authorized Distributors before the extended warranty expires.

## Disposal



### For EU Customers only - WEEE Marking

This symbol on the product or on its packaging indicates that this product must not be disposed of with your other household waste. Instead, it is your responsibility to dispose of your waste equipment by handing it over to a designated collection point for the recycling of waste electrical and electronic equipment. The separate collection and recycling of your waste equipment at the time of disposal will help to conserve natural resources and ensure that it is recycled in a manner that protects human health and the environment. For more information about where you can drop off your waste equipment for recycling, please contact your local city office, your household waste disposal service or the shop where you purchased the product.



**CE Marking** is the symbol as shown on the left of this page. The letters "CE" are the abbreviation of French phrase "Conformité Européene" which literally means "European Conformity". The term initially used was "EC Mark" and it was officially replaced by "CE Marking" in the Directive 93/68/EEC in 1993. "CE Marking" is now used in all EU official documents.

# 1. Introduction

The RMC-185 is a cost effective physical controller designed specifically for control of the KMU-100 4K Multi-Camera Processor. The RMC-185 interfaces with the KMU-100 via an RS-422 interface.

The RMC-185 panel style design allows easy control of the KMU-100 with the hard keys giving the user quick access to main functions of the KMU-100. In addition, you can also use the joystick to move the selected frame view.

*That's Datavideo; sharing the value!*

## 1.1 Features

- Remote control of up to eight selected frame views.
- Pan, Tilt and Zoom with speed control by joystick.
- Storing multiple presets for frame view settings.
- Full remote control of the KMU-100 via RS-422 connection.
- An LCD display showing setup menu options.
- Three Multiviewer modes (Preview, Motion and Quad)
- Compact design for easy installation

## 1.2 Device Setup

The RMC-185 works in pair with the KMU-100. First of all, connect the power to the RMC-185 through a power cable. After that, the RMC-185 (RJ-45) is connected to the KMU-100 (DSub) using an RJ-45-to-DSub cable. Finally, turn ON the RMC-185 device switch to start manipulating your KMU-100. Please see the system diagram below for the overall system setup.

**Note: The communication protocol between the two devices is RS-422.**

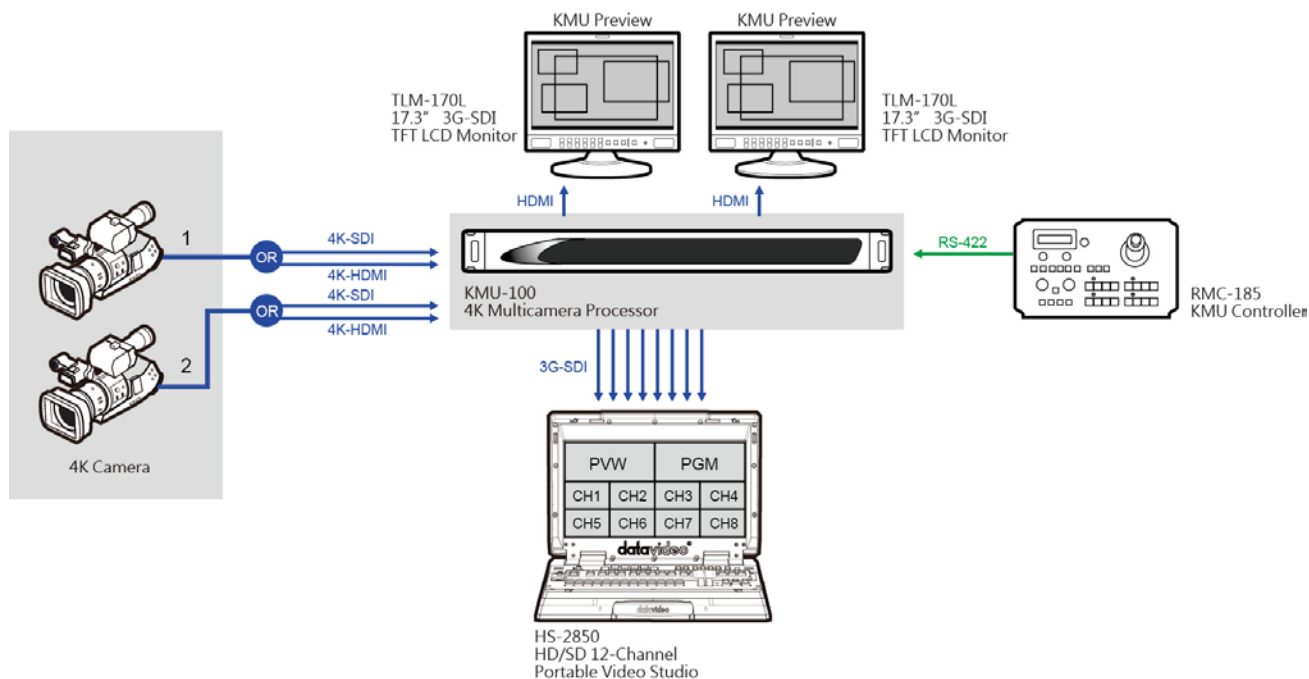

## 2. Connections and Controls

### 2.1 Front Panel – Keyboard

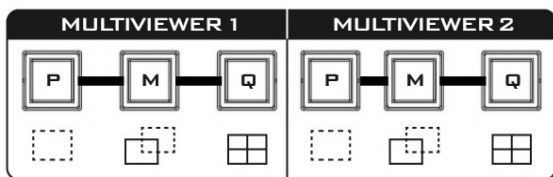
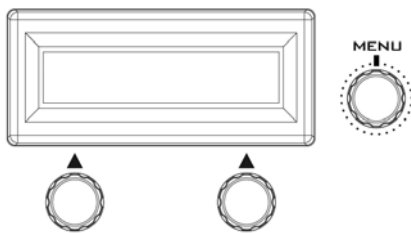
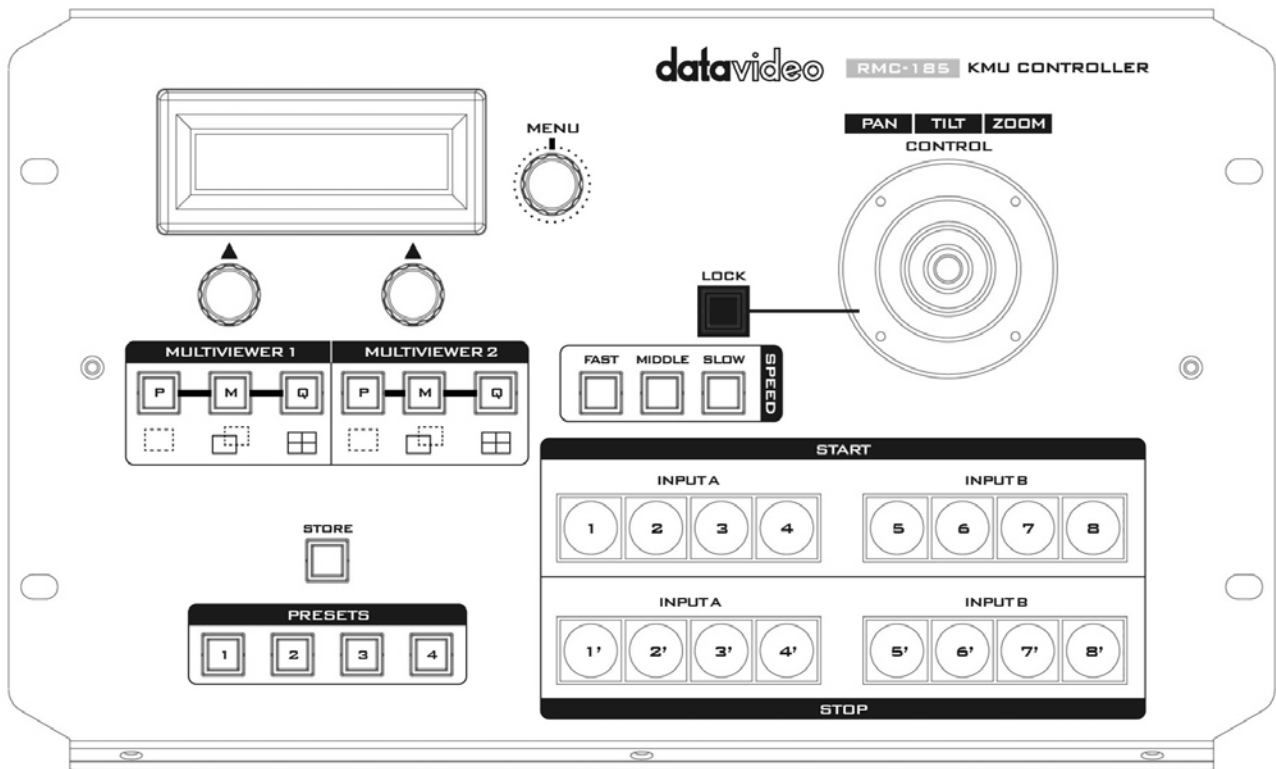

#### LCD Display

The RMC-185 status or the setup menu options are displayed on the LCD panel.

#### Menu Control Dials

The RMC-185 configuration menu can be entered and browsed using these dials. Push to select a specific item and rotate to browse the selected menu option.

#### Multiviewer Mode Select

##### **P** Preview

Press to display current position of the selected frame.

##### **M** Motion

Press to display motion of the selected frame (playback of the motion from **Start** position to **End** position).

##### **Q** Quad View

Simultaneous display of all four frames.

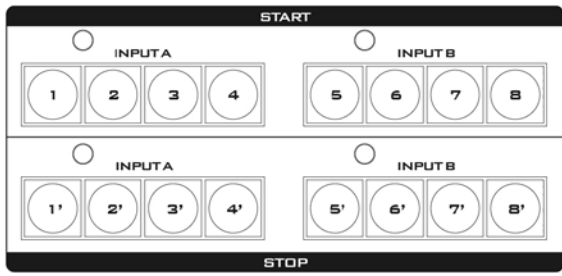

### Frame selection buttons (Top row)

Press one button (1-8) to select an active frame. After selecting an active frame, you can press the same button to switch between Start and End positions.

### Motion operation buttons (Bottom row)

Press one button to start motion of an active frame and the second button press pauses motion. Long pressing the same button for about 2 seconds will stop motion. Button LED flashes while the motion is in progress. When the motion is stopped, the button LED will stop flashing and turn to constant lit.

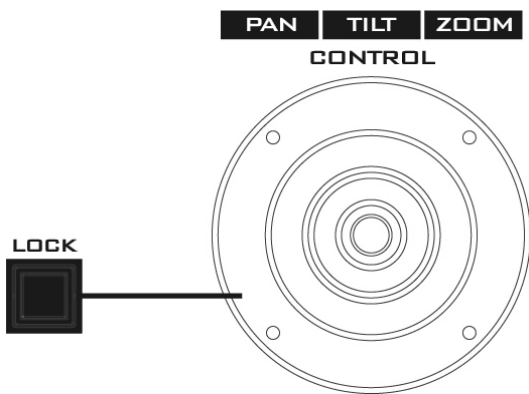

### PTZ Joystick Control

**Note:** Before attempting to use the joystick to PAN, TILT or ZOOM a selected frame, first make sure the LOCK button is not enabled.

**PAN** – Move the joystick left or right to pan the selected frame from left to right or vice versa.

**TILT** – Move the joystick up or down to tilt the selected frame up or down.

**ZOOM** – Twist the joystick clockwise (to the right) or anti-clockwise (to the left) to have the selected frame zoom in or out.

### LOCK Button

When enabled, the joystick will be in the lock state. To resume its functional status, simply press the button once to unlock the joystick.

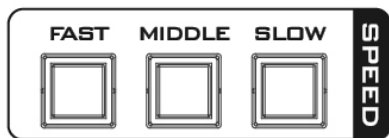

### Speed

The speed at which the selected frame moves can be chosen by pressing one of the three speed buttons.



### STORE

Pressing this button enters the RMC-185 into **STORE MODE**. When activated, this allows the current device setting to be stored in a chosen Preset Button by pressing the corresponding Preset Button. Press again to exit **STORE MODE**.



### PRESETS

The preset buttons may be used to store up to four device settings. Each button corresponds to one stored device preset. Simply press the button to recall the saved preset. Once activated, the button LED will be turned ON.

## 2.2 Rear Panel - Connections

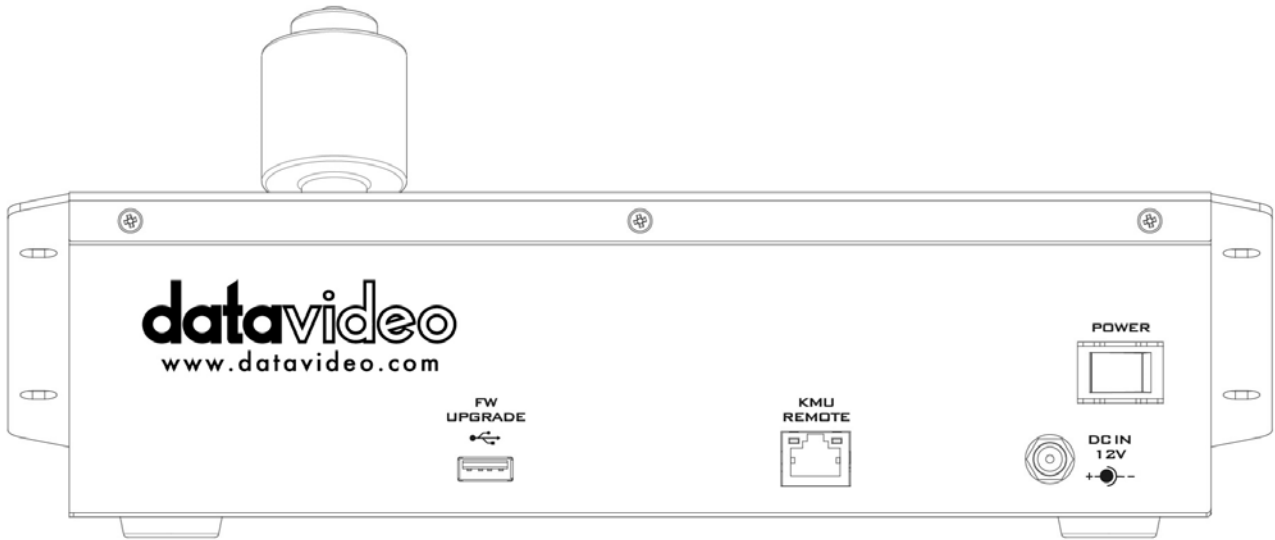

### Firmware Upgrade

USB type A port for connection to a computer during the firmware upgrade process.

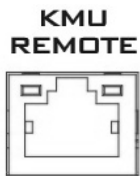

### RJ-45 port to connect the KMU-100

The RJ-45 ports are provided on the RMC-185 rear to connect the KMU-100. The communication protocol is **RS-422**, so use an RJ-45-to-DSub cable to connect the RMC-185 to the RS-422 port located on the KMU-100 rear panel.



### DC In Socket

Connect the supplied 12V 0.5A PSU to this socket. The connection can be secured by screwing the outer fastening ring of the DC In plug to the socket.

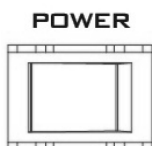

### Power On/Off Switch

Switches the device ON / OFF.



### 3. Menu Setup

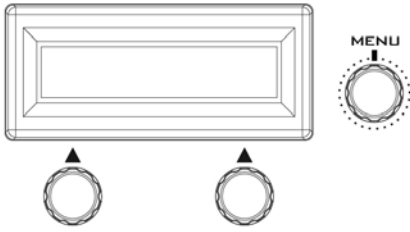

Press the **MENU** button to enter the **MENU**. The RMC-185 status or the setup menu options are displayed on the LCD panel.

Press the dial to select a particular option and rotate the dial to browse through the option items.

<b>FN1</b>	Exit			
<b>FN2</b>	Input A Source	1 x SDI 4 x SDI HDMI Clone		
<b>FN3</b>	Input B Source	1 x SDI 4 x SDI HDMI Clone		
<b>FN4</b>	Output Format	PAL NTSC PAL 16:9 NTSC 16:9 720p50 720p59.94 720p60 1080p25 1080p29.97 1080p30 1080i50 1080i59.94 1080i60 1080p50 1080p59.94 1080p60		
<b>FN5</b>	Genlock Set	Genlock	Enable Disable	
		Termination	Enable Disable	
<b>FN6</b>	Genlock Status	Ref	Present Loose Lock Unlock	
			Format	Detected video format Up to 1080p60
<b>FN7</b>	SDI 3G Type	Type A		
		Type B		

<b>FN8</b>	Multi. Swap	ON	
		OFF	
<b>FN9</b>	Multi. SDI	ON	
		OFF	
<b>FN10</b>	Trigger Set	Motion No.	1 – 8
		Trigger Level	Low
			High
<b>FN11</b>	KMU-100 Ver.	FPGA / HARDWARE / NIOS / ARM	
<b>FN12</b>	KMU-100 Temp	FPGA Temperature	
		PCB Board Temperature	
<b>FN13</b>	Firmware Ver.	RMC-185 Firmware Version	

### **FN1. Exits the MENU (EXIT)**

Exits the setup menu mode.

### **FN2. Input A Source Assignment (Input A Source)**

In this option, you may select a source for input A image processing. The available interfaces are:

- 1xSDI – SDI video interface up to 12G (SD is not supported)
- 4xSDI – quad SDI video
- HDMI – HDMI 2.0
- Clone – Input B as a source

### **FN3. Input B Source Assignment (Input B Source)**

In this option, you may select a source for input B image processing. The available interfaces are:

- 1xSDI – SDI video interface up to 12G (SD is not supported)
- 4xSDI – quad SDI video
- HDMI – HDMI 2.0
- Clone – Input A as a source

### **FN4. Output Format Selection (Output Format)**

There are many video output formats available for selection. The available video output formats are listed as follows:

- PAL
- NTSC
- PAL 16:9
- NTSC 16:9
- 720p50
- 720p59.94
- 720p60
- 1080p25
- 1080p29.97
- 1080p30
- 1080i50
- 1080i59.94
- 1080i60
- 1080p50

- 1080p59.94
- 1080p60

#### **FN5. Genlock Setting (Genlock Set)**

This option enables/disables the genlock functionality and turns ON/OFF internal 75 Ohm termination.

#### **FN6. Genlock Status Display (Genlock Status)**

Display current genlock status by returning values detected from sync signal.

#### **FN7. Selection of SDI 3G Type (SDI 3G Type)**

Enabling of 3G-SDI signal type on output ports (available modes are Type A and Type B).

#### **FN8. HDMI Multiviewer Swap (Multi. Swap)**

If **Multi. Swap** is set to ON, the multiviewer contents of the KMU-100 HDMI outputs will be swapped.

#### **FN9. SDI 4 Multiviewer (Multi. SDI)**

If **Multi.SDI** is set to ON, the 4<sup>th</sup> SDI output of every output channel on the KMU-100 works as a multiviewer output.

#### **FN10. External Motion Trigger Setting (Trigger Set)**

In this option, you will be able to configure the external motion trigger method. Motion 1-8 can be controlled by an external device using the level trigger method. You can either set the trigger method to low level trigger or high level trigger.

#### **FN11. KMU-100 Firmware Version Display (KMU-100 Ver.)**

Upon entering the **KMU-100 Ver.** Option, the KMU-100 firmware version will be displayed.

#### **FN12. Display of KMU-100 FPGA and PCB Board Temperatures (KMU-100 Temp)**

In the **KMU-100 Temp** option, you will be able to check measured temperatures of the KMU-100 FPGA and PCB boards.

#### **FN13. RMC-185 Firmware Version Display (Firmware Ver.)**

Upon entering the **Firmware Ver.** option, the RMC-185 firmware version will be displayed.

## 4. Storing Different Device Settings

The RMC-185 allows you to store up to four device settings. Follow the procedure below to store the current device setting to one of the preset buttons.

To store a device setting:

1. Adjust the frame positions using the joystick.
2. Push the **STORE** button and it will turn red.



3. Press a preset button to save the current device setting.



4. The selected preset button will remain ON for 2-3 seconds and the button LED will be turned OFF after the device setting is successfully saved.

## 5. Firmware Upgrade Procedure

From time to time, Datavideo may release new firmware to either add new features or to fix reported bugs in the current RMC-185 firmware. Customers can update the firmware themselves if they wish or they can contact their local dealer or reseller for assistance should they prefer this method.

This section describes the firmware update process and it should take **approximately few minutes to complete**. Once started, **the update process should not be interrupted in any way** as this could result in a non-responsive unit.

### Requirement

- Latest firmware update files (bootloader and application firmware)
- A USB A to USB A cable not longer than 2 meters
- A Windows PC with USB 2.0 ports or above

1. Power off the RMC-185 and use a USB cable (USB A to USB A) to connect the USB firmware

upgrade port  on the RMC-185 rear panel to a USB port on the PC.

2. Press and hold the four buttons indicated with  at the same time.

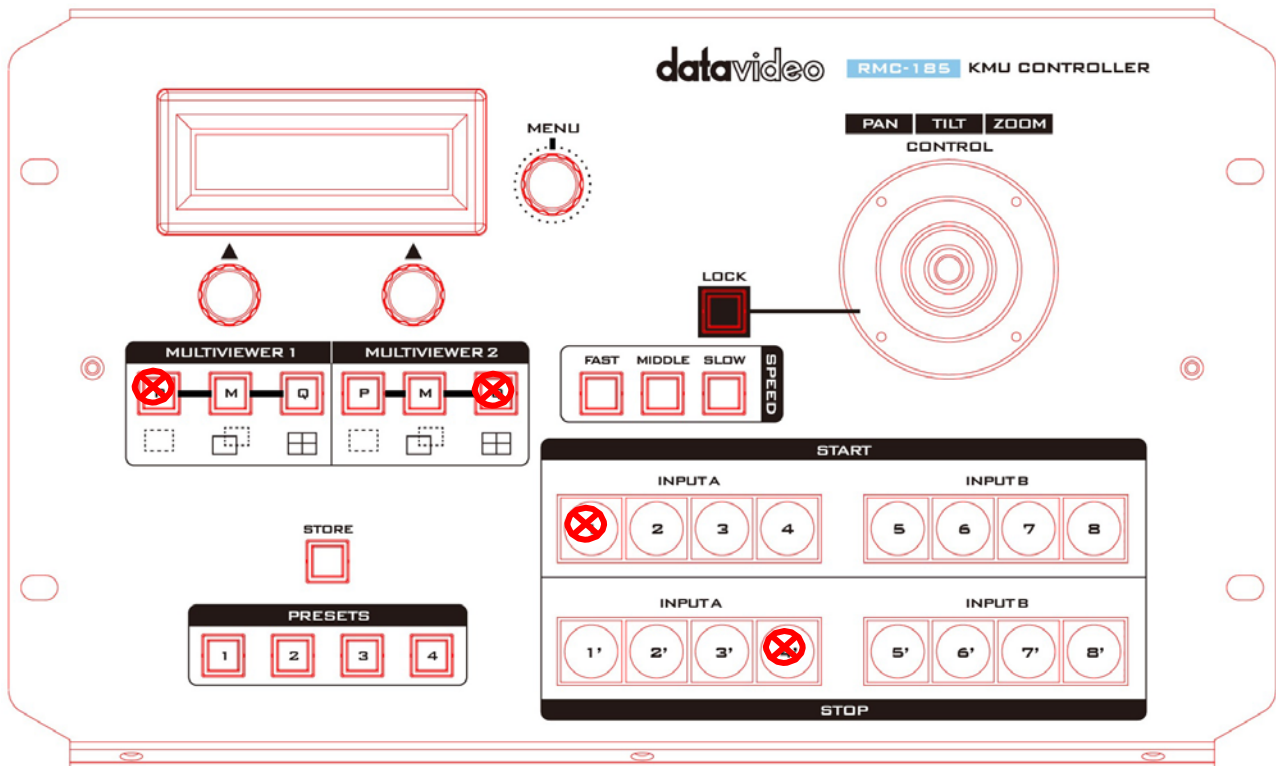

3. With an assistant's help, one person switches on the RMC-185 device while another person presses and holds the buttons indicated with .

4. The user may release the buttons once the RMC-185 LCD panel displays the following information.

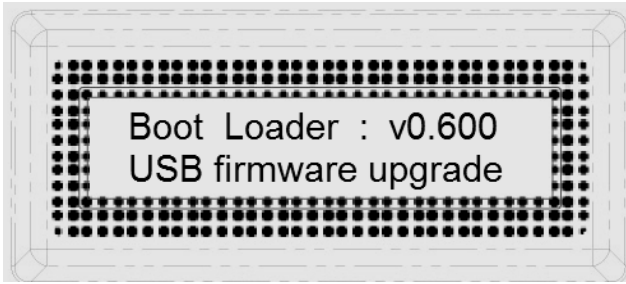

5. The RMC-185 device (**RMC-185\_U38**) will appear as a removable storage device on the PC as shown below.

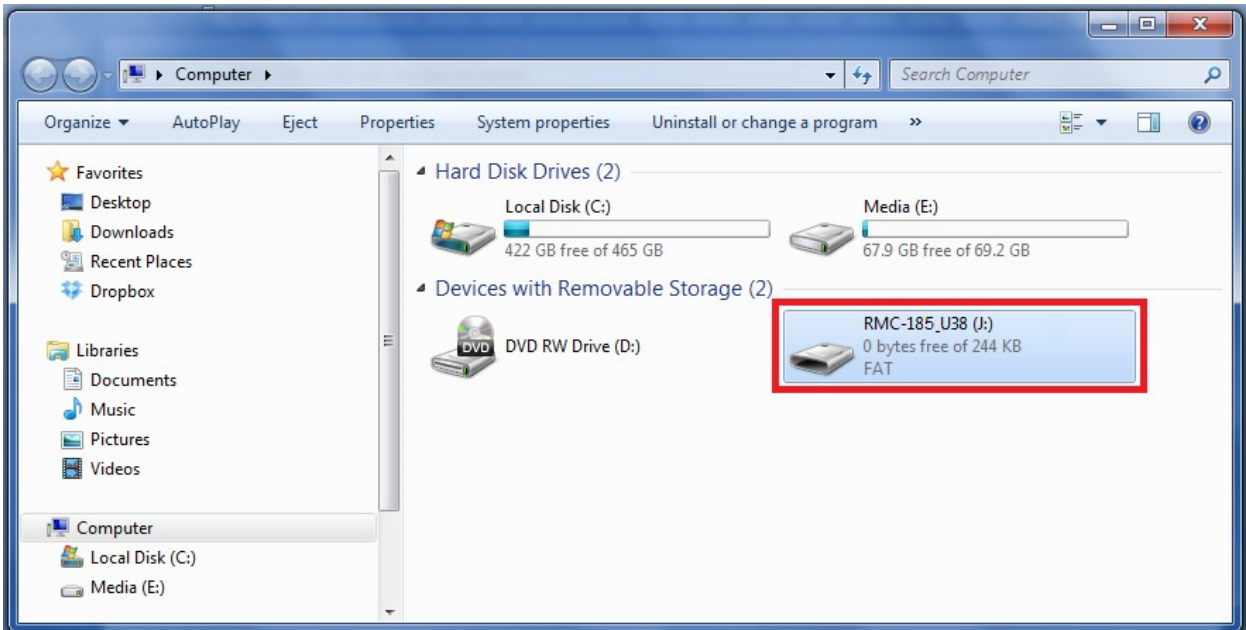

6. Double click the RMC-185\_U38 removable storage device and delete the "bootcode.bin" file.
7. Copy and paste the latest bootloader firmware file (bootcode.bin) into the RMC-185\_U38 removable storage device.
8. Reboot the RMC-185 device until the LCD displays the following.

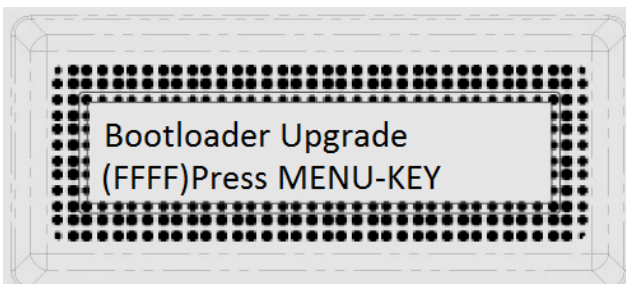

9. Press the MENU key to start the firmware upgrade and do not disconnect the power before the upgrade is complete.

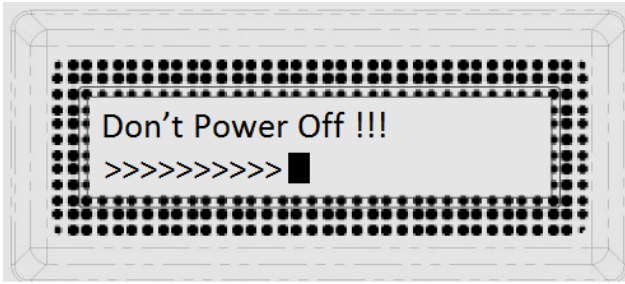

10. After the bootloader firmware upgrade is complete, the LCD display will show the following and the user may proceed to upgrading the application firmware.

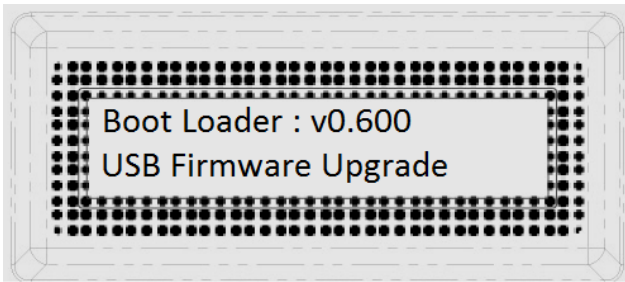

11. Remove bootcode.bin from the RMC-185 device and copy and paste the application firmware into the RMC-185 device.

Name	Date modified	Type	Size
 RMC185	2015/5/14	BIN	76 KB

12. Reboot the RMC-185 device again and the LCD display will now show the following.

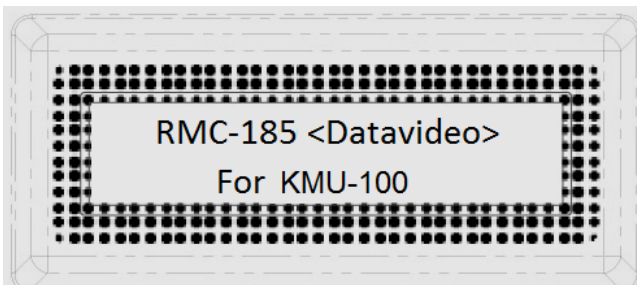

13. The RMC-185 device is now ready for controlling the connected KMU device.

## 6. Frequently-Asked Questions

This section describes problems that you may encounter while using RMC-185. If you have any questions, please refer to related sections and follow all suggested solutions. If problem still exists, please contact your distributor or the service center.

<b>No.</b>	<b>Problems</b>	<b>Solutions</b>
1.	What is the RJ-45 port used for?	It is used for connecting the RMC-185 to the KMU-100. Please use an RJ-45-to-DSub cable. The DSub end should be a male connector.



## 7. Dimensions

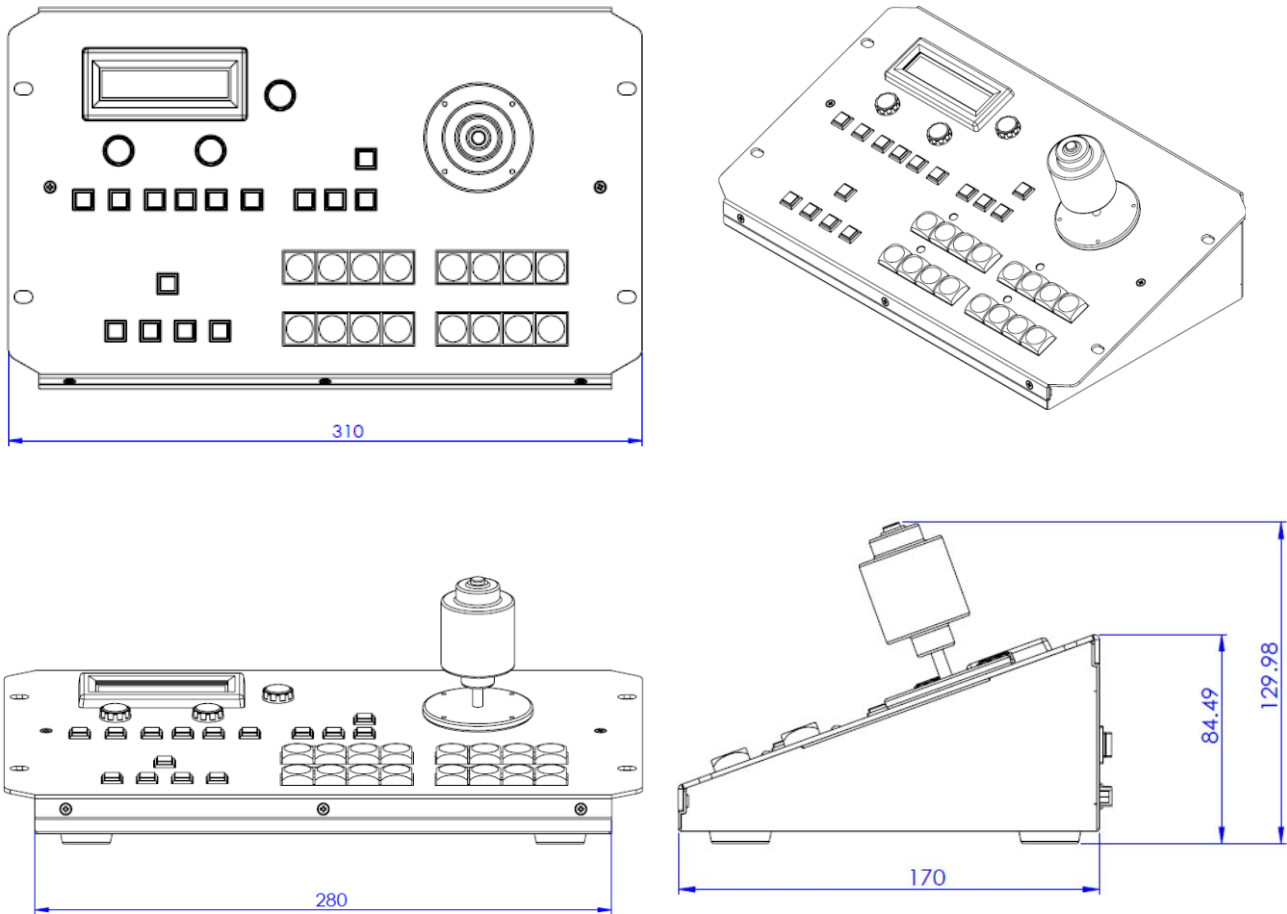

All measurements in millimeters (mm)

## 8. Specifications

RMC-185 KMU Controller	
<b>Firmware Upgrade</b>	USB
<b>Power</b>	DC 12V 0.5A
<b>Dimensions (W x H x D)</b>	310 x 129.98 x 170 (mm)
<b>Net Weight</b>	1.5 Kg
<b>Gross Weight</b>	2.0 Kg
<b>Operating Temperature</b>	0°C to 50°C (32°F to 122°F)
<b>Humidity</b>	10% to 80%

# Service & Support

It is our goal to make owning and using Datavideo products a satisfying experience. Our support staff is available to assist you to set up and operate your system. Contact your local office for specific support requests. Plus, please visit [www.datavideo.com](http://www.datavideo.com) to access our FAQ section.

## Datavideo Taiwan

Datavideo Technologies Co. Ltd  
10F. No. 176, Jian 1st Rd., Chung Ho  
District, New Taipei City 235, Taiwan,  
R.O.C.  
Tel: +886-2-8227-2888  
Fax: +886-2-8227-2777  
E-mail: [service@datavideo.com.tw](mailto:service@datavideo.com.tw)

## Datavideo Europe

Datavideo Technologies Europe BV  
Floridadreef 106  
3565 AM Utrecht,  
The Netherlands  
Tel: +31-30-261-96-56  
Fax: +31-30-261-96-57  
E-mail: [info@datavideo.nl](mailto:info@datavideo.nl)

## Datavideo United Kingdom

Datavideo UK Limited  
Units1 & 2 Waterside Business Park  
Hadfield, Glossop, Derbyshire  
SK13 1BE, UK  
Tel: +44-1457 851 000  
Fax: +44-1457 850 964  
E-mail: [sales@datavideo.co.uk](mailto:sales@datavideo.co.uk)

## Datavideo USA

Datavideo Corporation  
7048 Elmer Avenue.  
Whittier, CA 90602,  
U.S.A.  
Tel: +1-562-696 2324  
Fax: +1-562-698 6930  
E-mail: [sales@datavideo.us](mailto:sales@datavideo.us)

## Datavideo China

Datavideo Technologies China Co  
601, Building 10, No. 1228,  
Rd. Jiangchang,  
Jingan District, Shanghai  
Tel: +86 21-5603 6599  
Fax: +86 21-5603 6770  
E-mail: [service@datavideo.cn](mailto:service@datavideo.cn)

## Datavideo Singapore

Datavideo Technologies (S) PTE Ltd  
No. 178 Paya Lebar Road #06-03  
Singapore 409030  
Tel: +65-6749 6866  
Fax: +65-6749 3266  
E-mail: [sales@datavideo.sg](mailto:sales@datavideo.sg)

## Datavideo Hong Kong

Datavideo Hong Kong Ltd  
G/F., 26 Cross Lane  
Wanchai, Hong Kong  
Tel: +852-2833-1981  
Fax: +852-2833-9916  
E-mail: [info@datavideo.com.hk](mailto:info@datavideo.com.hk)

## Datavideo France

Datavideo France s.a.r.l  
Cité Descartes 1, rue Albert Einstein  
Champs sur Marne  
774477-Marne la Vallée cedex 2  
Tel: +33-1-60370246  
E-mail: [info@datavideo.fr](mailto:info@datavideo.fr)

## Datavideo India

Datavideo Technologies India Pvt Ltd  
A-132, Sec-63, Noida-201307,  
Uttar Pradesh (UP), India.  
Tel: +91-0120-2427337  
Fax: +91-0120-2427338  
E-mail: [sales@datavideo.in](mailto:sales@datavideo.in)



Please refer to our website for update the latest version manual.  
[www.datavideo.com/product/RMC-185](http://www.datavideo.com/product/RMC-185)

**datavideo**  
[www.datavideo.com](http://www.datavideo.com)