

MULTI-FORMAT MATRIX SWITCHER XS-1HD

Owner's Manual

Before using the XS-1HD, ensure that its system program is at the most recent version. For information on available upgrades for the system program, see the Roland website (<https://proav.roland.com/>).

You can check the system program version by pressing the [MENU] button → "System" → "Version."



Owner's Manual (this document)

Read this first. It explains the basic things you need to know in order to use the XS-1HD.



PDF Manual (download from the Web)

- **Reference Manual**

This explains all menu items and RS-232 commands of the XS-1HD.



To obtain the PDF manual

1. Enter the following URL in your computer.

<https://proav.roland.com/>



2. Go to the XS-1HD product page and click the "Support."

Contents

USING THE UNIT SAFELY	3	Audio Operations	18
IMPORTANT NOTES	5	Adjusting the Volume (Level)	18
Panel Descriptions	6	Specifying the State of Each Channel (State)	18
Top Panel/Front Panel	6	Muting the Audio (Mute)	18
Rear Panel/Side Panel		Linking Audio Output to Video Switching	
(Connecting Your Equipment) ...	8	(Audio Follow) ..	18
Basic Operation	10	Changing the Audio Source of Input Channel 4 ..	18
Turning the Power On/Off	10	Matching the Output Timing	
Operating the Menu	10	of the Video and Audio	18
List of Compatible Video Formats	11	Other Functions	19
Input Video Formats	11	Using Quick Edit to Adjust Video or Audio	19
Output Video Formats	11	Using the Video Quick Edit	19
Video Operations	12	Using the Audio Quick Edit	20
Setting the Output Format	12	Saving or Recalling Settings (Memory)	21
Switching Video	12	Saving the XS-1HD's Settings	
About the Screen Modes	12	as a File on a USB Flash Drive ...	22
Switching in Matrix Mode	13	Formatting a USB Flash Drive	23
Switching in Split Mode	14	Returning to the Factory Settings	
Switching in Switcher Mode	15	(Factory Reset)	23
Outputting a Loaded Still Image	16	Appendices	24
Fading the Output Video	17	Block Diagram	24
Inputting Copy-Protected (HDCP) Video	17	Video Section	24
		Audio Section	26
		Troubleshooting	28
		Main Specifications	29
		Dimensions	30
		About the POWER Button Cover	30

Before using this unit, carefully read "USING THE UNIT SAFELY" (p. 3) and "IMPORTANT NOTES" (p. 5). After reading, keep the document(s) where it will be available for immediate reference.

Check the Included Items

Check that all of the following included items are present. If any of the included items are missing, contact your dealer.

XS-1HD unit



AC adaptor / power cord



* The shape of the power cord's plug varies depending on the country.

Owner's Manual



POWER button cover / screws (2)





* This is a cover that can be attached to prevent accidental operation of the [POWER] button (p. 30).







USING THE UNIT SAFELY

INSTRUCTIONS FOR THE PREVENTION OF FIRE, ELECTRIC SHOCK, OR INJURY TO PERSONS

About WARNING and CAUTION Notices

 WARNING	Used for instructions intended to alert the user to the risk of death or severe injury should the unit be used improperly.
 CAUTION	Used for instructions intended to alert the user to the risk of injury or material damage should the unit be used improperly. * Material damage refers to damage or other adverse effects caused with respect to the home and all its furnishings, as well to domestic animals or pets.

About the Symbols

	The  symbol alerts the user to important instructions or warnings. The specific meaning of the symbol is determined by the design contained within the triangle. In the case of the symbol at left, it is used for general cautions, warnings, or alerts to danger.
	The  symbol alerts the user to items that must never be carried out (are forbidden). The specific thing that must not be done is indicated by the design contained within the circle. In the case of the symbol at left, it means that the unit must never be disassembled.
	The  symbol alerts the user to things that must be carried out. The specific thing that must be done is indicated by the design contained within the circle. In the case of the symbol at left, it means that the power-cord plug must be unplugged from the outlet.

ALWAYS OBSERVE THE FOLLOWING

WARNING

To completely turn off power to the unit, pull out the plug from the outlet

Even with the power switch turned off, this unit is not completely separated from its main source of power. When the power needs to be completely turned off, turn off the power switch on the unit, then pull out the plug from the outlet. For this reason, the outlet into which you choose to connect the power cord's plug should be one that is within easy reach and readily accessible.



Concerning the Auto Off function

The power to this unit will be turned off automatically after a predetermined amount of time has passed since it was last used for playing music, or its buttons or controls were operated (Auto Off function). If you do not want the power to be turned off automatically, disengage the Auto Off function (p. 10).



Do not disassemble or modify by yourself

Do not carry out anything unless you are instructed to do so in the owner's manual. Otherwise, you risk causing malfunction.



Do not repair or replace parts by yourself

Refer all servicing to your retailer, the nearest Roland Service Center, or an authorized Roland distributor, as listed on the "Information."





Do not place in an unstable location

Otherwise, you risk injury as the result of the unit toppling over or dropping down.



WARNING

Do not use or store in the following types of locations

- Subject to temperature extremes (e.g., direct sunlight in an enclosed vehicle, near a heating duct, on top of heat-generating equipment); or are 
- Damp (e.g., baths, washrooms, on wet floors); or are 
- Exposed to steam or smoke; or are
- Subject to salt exposure; or are
- Exposed to rain; or are
- Dusty or sandy; or are
- Subject to high levels of vibration and shakiness; or are
- Placed in a poorly ventilated location.

Use only the supplied AC adaptor and the correct voltage

Be sure to use only the AC adaptor supplied with the unit. Also, make sure the line voltage at the installation matches the input voltage specified on the AC adaptor's body. Other AC adaptors may use a different polarity, or be designed for a different voltage, so their use could result in damage, malfunction, or electric shock.



Use only the supplied power cord

Use only the attached power cord. Also, the supplied power cord must not be used with any other device.



Do not bend the power cord or place heavy objects on it

Otherwise, fire or electric shock may result.



Avoid extended use at high volume

Use of the unit at high volume for extended periods of time may cause hearing loss. If you ever experience any hearing loss or ringing in the ears, you should immediately stop using the unit and consult a specialized physician.



USING THE UNIT SAFELY

WARNING

Do not allow foreign objects or liquids to enter unit; never place containers with liquid on unit

Do not place containers containing liquid (e.g., flower vases) on this product. Never allow foreign objects (e.g., flammable objects, coins, wires) or liquids (e.g., water or juice) to enter this product. Doing so may cause short circuits, faulty operation, or other malfunctions.



Turn off the unit if an abnormality or malfunction occurs

Immediately turn the unit off, remove the AC adaptor from the outlet, and request servicing by your retailer, the nearest Roland Service Center, or an authorized Roland distributor, as listed on the "Information" when:



- The AC adaptor or the power cord has been damaged; or
- If smoke or unusual odor occurs; or
- Objects have fallen into, or liquid has been spilled onto the unit; or
- The unit has been exposed to rain (or otherwise has become wet); or
- The unit does not appear to operate normally or exhibits a marked change in performance.

Be cautious to protect children from injury

Always make sure that an adult is on hand to provide supervision and guidance when using the unit in places where children are present, or when a child will be using the unit.



Do not drop or subject to strong impact

Otherwise, you risk causing damage or malfunction.



Do not share an outlet with an unreasonable number of other devices

Otherwise, you risk overheating or fire.



Do not use overseas

Before using the unit in overseas, consult with your retailer, the nearest Roland Service Center, or an authorized Roland distributor, as listed on the "Information."



CAUTION

When disconnecting the power cord, grasp it by the plug

To prevent conductor damage, always grasp the power cord by its plug when disconnecting it.



CAUTION

Periodically clean the power plug

An accumulation of dust or foreign objects between the power plug and the power outlet can lead to fire or electric shock.



At regular intervals, be sure to pull out the power plug, and using a dry cloth, wipe away any dust or foreign objects that may have accumulated.

Disconnect the power plug whenever the unit will not be used for an extended period of time

Fire may result in the unlikely event that a breakdown occurs.



Route all power cords and cables in such a way as to prevent them from getting entangled

Injury could result if someone were to trip on a cable and cause the unit to fall or topple.



Avoid climbing on top of the unit, or placing heavy objects on it

Otherwise, you risk injury as the result of the unit toppling over or dropping down.



Never connect/disconnect a power plug if your hands are wet

Otherwise, you could receive an electric shock.



Disconnect all cords/cables before moving the unit

Before moving the unit, disconnect the power plug from the outlet, and pull out all cords from external devices.



Before cleaning the unit, disconnect the power plug from the outlet

If the power plug is not removed from the outlet, you risk receiving an electric shock.



Whenever there is a threat of lightning, disconnect the power plug from the outlet

If the power plug is not removed from the outlet, you risk causing malfunction or receiving an electric shock.



Handle the ground terminal carefully

If you remove the screw from the ground terminal, be sure to replace it; don't leave it lying around where it could accidentally be swallowed by small children. When refastening the screw, make that it is firmly fastened, so it won't come loose.



Keep small items out of the reach of children

To prevent accidental ingestion of the parts listed below, always keep them out of the reach of small children.



- Included Parts: POWER button cover, Screw

IMPORTANT NOTES

Power Supply

- Do not connect this unit to same electrical outlet that is being used by an electrical appliance that is controlled by an inverter or a motor (such as a refrigerator, washing machine, microwave oven, or air conditioner). Depending on the way in which the electrical appliance is used, power supply noise may cause this unit to malfunction or may produce audible noise. If it is not practical to use a separate electrical outlet, connect a power supply noise filter between this unit and the electrical outlet.
- The AC adaptor will begin to generate heat after long hours of consecutive use. This is normal, and is not a cause for concern.

Placement

- Using the unit near power amplifiers (or other equipment containing large power transformers) may induce hum. To alleviate the problem, change the orientation of this unit; or move it farther away from the source of interference.
- This unit may interfere with radio and television reception. Do not use this unit in the vicinity of such receivers.
- Noise may be produced if wireless communications devices, such as cell phones, are operated in the vicinity of this unit. Such noise could occur when receiving or initiating a call, or while conversing. Should you experience such problems, you should relocate such wireless devices so they are at a greater distance from this unit, or switch them off.
- When moved from one location to another where the temperature and/or humidity is very different, water droplets (condensation) may form inside the unit. Damage or malfunction may result if you attempt to use the unit in this condition. Therefore, before using the unit, you must allow it to stand for several hours, until the condensation has completely evaporated.
- Depending on the material and temperature of the surface on which you place the unit, its rubber feet may discolor or mar the surface.
- Do not place containers or anything else containing liquid on top of this unit. Also, whenever any liquid has been spilled on the surface of this unit, be sure to promptly wipe it away using a soft, dry cloth.

Repairs and Data

- Before sending the unit away for repairs, be sure to make a backup of the data stored within it; or you may prefer to write down the needed information. Although we will do our utmost to preserve the data stored in your unit when we carry out repairs, in some cases, such as when the memory section is physically damaged, restoration of the stored content may be impossible. Roland assumes no liability concerning the restoration of any stored content that has been lost.

Maintenance

- Never use benzine, thinners, alcohol or solvents of any kind, to avoid the possibility of discoloration and/or deformation.

Additional Precautions

- Any data stored within the unit can be lost as the result of equipment failure, incorrect operation, etc. To protect yourself against the irretrievable loss of data, try to make a habit of creating regular backups of the data you've stored in the unit.
- Roland assumes no liability concerning the restoration of any stored content that has been lost.
- Use a reasonable amount of care when using the unit's buttons, sliders, or other controls; and when using its jacks and connectors. Rough handling can lead to malfunctions.
- When disconnecting all cables, grasp the connector itself—never pull on the cable. This way you will avoid causing shorts, or damage to the cable's internal elements.
- To avoid disturbing others nearby, try to keep the unit's volume at reasonable levels.
- This unit allows you to switch images at high speed. For some people, viewing such images can cause headache, nausea, or other discomfort. Do not use this unit to create video that might cause these types of health problems. Roland Corporation will accept no responsibility for any such health problems that may occur in yourself or in viewers.
- Do not use connection cables that contain a built-in resistor.

Using External Memories

- Please observe the following precautions when handling external memory devices. Also, make sure to carefully observe all the precautions that were supplied with the external memory device.
 - Do not remove the device while reading/writing is in progress.
 - To prevent damage from static electricity, discharge all static electricity from your person before handling the device.

Panel Descriptions

Top Panel/Front Panel

[COLOR] buttons

These buttons operate as follows according to the screen mode.

Matrix mode / Switcher mode (p. 17)

The button applies a fade to the output video, outputting a single-color (background color) image. The [COLOR] button indicates the fade status.

Lit red	Faded out
Blinking red	Fading in/out
Lit white	Normal output

Split mode (p. 14)

Layers are hidden. When layers are hidden, the [COLOR] button is lit red.

MAIN level meter

p. 18

This indicates the volume level of the audio output.

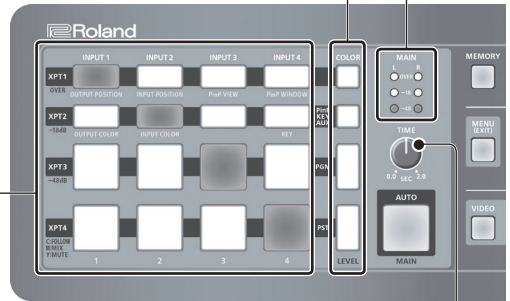

Cross-point buttons

These buttons operate as follows according to the screen mode.

* Buttons for which valid video is being input are lit white.

Matrix mode (p. 13)

These buttons switch the cross-point of the video channel.

Split mode (p. 14)

These buttons select the video to composite.

Switcher mode (p. 15)

XPT1	— (Not used.)			
XPT2	These buttons select the video source used as the PinP inset screen. The color in which the button is lit indicates the output destination of the composited result.			
	<table border="1"> <tr> <td>Lit green</td> <td>Preview output only</td> </tr> <tr> <td>Lit red</td> <td>Final output, preview output</td> </tr> </table> <p>* The PinP inset screen can also be key-composited. * If the AUX bus is assigned to the VIDEO OUTPUT 3 connector, these buttons select the input channel that is sent to the AUX bus.</p>	Lit green	Preview output only	Lit red
Lit green	Preview output only			
Lit red	Final output, preview output			
XPT3 (PGM)	These buttons select the final video output. The button of the channel that is being finally output is lit red. * When compositing video, these buttons select the background video			
XPT4 (PST)	These buttons select the preset video (the video that will be output next). The selected button is lit green.			

[TIME] knob

p. 13, 14, 15

This knob specifies the transition time

* This is also used as the fade time of the video output (p. 17) and the fade time when compositing video.

[MEMORY] button

p. 21

This button turns the memory function on/off. If this is on, up to 16 sets of the video/audio settings and the state of the operation panel can be saved and recalled.

- Save (lit red): Long-press the button
- Recall (lit green): Press the button

* When the memory function is on, the cross-point buttons operate as memory select buttons 1–16.

HDCP indicator

p. 17

This indicator is lit, blinking, or unlit according to the HDCP (copy protection) setting and according to whether an HDCP-compliant device is connected.

SCREEN MODE indicators

p. 12

These indicators show the current screen mode.

SETUP area

p. 10

[MENU] button

Turning this button on (lit) makes a menu (OSD) appear on the monitor that is connected to the VIDEO OUTPUT 4 connector.

If you've moved to a lower-level item of the menu, this button returns you to the next higher level.

[ENTER] button

This button moves to a lower-level menu, or executes an operation.

[CURSOR] knob

This knob selects a menu category or item.

[VALUE] knob

This knob changes the value of a menu item.

Video fader

p. 15

When the screen mode is "switcher mode," this makes the preset video (the video to output next) the final output.

Cooling vent



Heat from inside the XS-1HD is vented here to keep the unit from overheating.

NOTE

Do not block the cooling vent. If the cooling vent is blocked, the interior of the XS-1HD might overheat, causing it to malfunction.

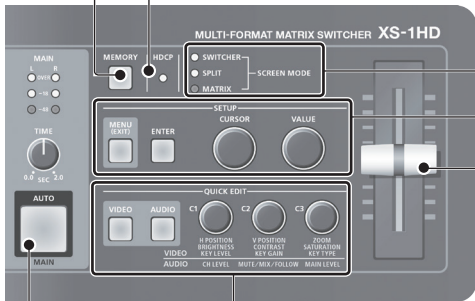

QUICK EDIT area

p. 19, 20

[VIDEO], [AUDIO] buttons

These buttons turn on/off the quick edit function for video or audio. When the function is on, you can use the operation panel to adjust the video or audio.

[C1], [C2], [C3] knobs

These knobs adjust the value of the corresponding menu item.

* If the quick edit function is on, use the cross-point buttons to select the operation that these knobs will perform.

[AUTO] button

p. 15

When the screen mode is "switcher mode," this button automatically switches between the final output video and the preset video (the video to output next).

Rear Panel/Side Panel (Connecting Your Equipment)

* To prevent malfunction and equipment failure, always turn down the volume, and turn off all the units before making any connections.

VIDEO OUTPUT 1–4 connectors

These connectors output video. You can connect them to devices such as projectors, video recorders, or external displays.

* The VIDEO OUTPUT 4 connector displays a menu (OSD) on the connected monitor (p. 10).



HDMI input connector

When in switcher mode (p. 15)

VIDEO OUTPUT 1 connector

These connectors output the video that is selected by the XPT3 row (PGM) of the cross-point buttons.

VIDEO OUTPUT 2, 3 connectors

These connectors output the following video, depending on the Composition menu's "Mode" setting.

Connector	Mode = PinP & Key	Mode = AUX
OUTPUT 2	Preview the PinP or key-composited result	Final output video
OUTPUT 3	Final output video	AUX bus video

VIDEO OUTPUT 4 connector

This connector outputs a multi-view of the channel 1–4 input videos. It also shows a tally frame.

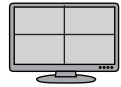

* The output format is fixed at "1080p/60 Hz"

* The frame rate will decrease to approximately 5 fps.

[POWER] button

p. 10

This button turns the power on/off.

* By attaching the included POWER button cover, you can prevent accidental operation of the [POWER] button (p. 30).



VIDEO INPUT 1–4 connectors

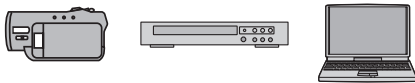

These connectors input HDMI signals from video devices such as a video camera or BD player, or from a computer.

* The input format is automatically recognized.

* In the Input menu, the "Input Status" shows the video format that is being input to each channel, and the presence or absence of an HDCP signal.

* By executing "EDID Copy" in the System menu, you can copy the EDID of the output-destination device connected to a VIDEO OUTPUT connector and use it as the EDID of a VIDEO INPUT connector.

HDMI output connector

USB MEMORY port

p. 16, 22



* When using a USB flash drive for the first time, you must format it using the XS-1HD (p. 23).

You can connect a USB flash drive here. It is used when loading a still image, or when saving or loading settings

AUDIO OUTPUT jacks

These jacks output the resulting audio mix. Connect them to an audio recorder, amp, or speakers. These are RCA phono-type jacks.

Audio input jacks

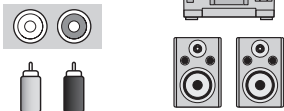

PHONES jack

Connect headphones to this jack. This is a stereo mini-type jack.



RS-232 connector

A remote-control device (such as a computer that supports RS-232) can be connected here to remotely control the XS-1HD.

RS-232 connector

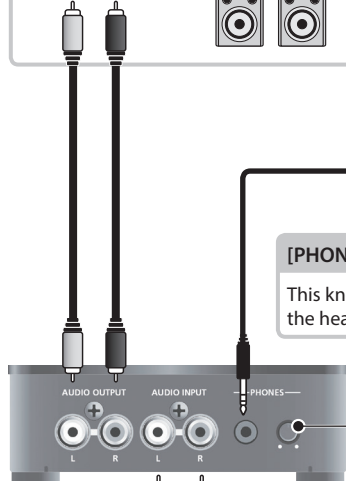

[PHONES] knob

This knob adjusts the volume of the headphones.

Ground terminal

Connect this to an external earth or ground.
* Connect this if necessary.

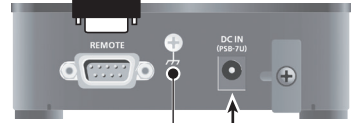

AUDIO INPUT jacks



Audio output jacks

These jacks input audio signals from a video device or audio device such as an audio mixer or CD player. These are RCA phono-type jacks.

DC IN jack

Connect the included AC adaptor to this jack.

Place the AC adaptor so the side with the indicator faces upwards and the side with textual information faces downwards. The indicator will light when you plug the AC adaptor into an AC outlet.

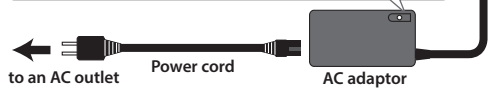

* To prevent the inadvertent disruption of power to your unit (should the plug be pulled out accidentally), and to avoid applying undue stress to the jack, anchor the power cord using the cord hook, as shown in the illustration.



Basic Operation

Turning the Power On/Off

* Before turning the unit on/off, always be sure to turn the volume down. Even with the volume turned down, you might hear some sound when switching the unit on/off. However, this is normal and does not indicate a malfunction.

Turning the power on

1. Make sure that all devices are powered-off.
2. On the rear panel of the XS-1HD, press the [POWER] button to turn on the power.

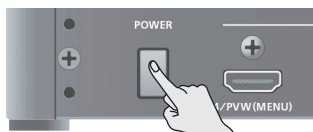

3. Turn on the power of the source devices.
Turn on the power of the source devices that are connected to the XS-1HD's input connectors, such as video cameras.
4. Turn on the power of the output devices.
Turn on the power of the devices that are connected to the XS-1HD's output connectors, such as projectors.

Turning the power off

1. Turn off the power in the order of output devices → source devices.
2. Press the XS-1HD's [POWER] button to turn off the power.

About the auto-off function

If 240 minutes pass while the XS-1HD remains in the following state, the power turns off automatically (auto-off function).

- The XS-1HD is not operated
- Audio or video are not input
- No output device is connected

If you do not want the power to be turned off automatically, disengage the Auto Off function. [MENU] button → "System" → set "Auto Power Off" to "Disabled."

NOTE

- Any settings that you are in the process of editing will be lost when the power is turned off. If you have any settings that you want to keep, you should save them beforehand.
- To restore power, turn the power on again.

Operating the Menu

Here's how to display the menu, and make settings for the XS-1HD itself and for video and audio.

* The menu is shown only on the monitor that's connected to the VIDEO OUTPUT 4 connector.

1. Press the [MENU] button to display the menu.

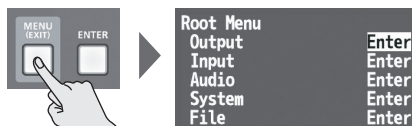

The [MENU] button is lit, and the menu categories are displayed.

2. Turn the [CURSOR] knob to select a category, and press the [ENTER] button to confirm.

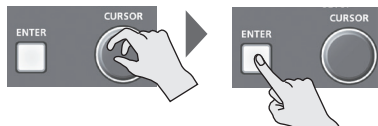

The menu items of the selected category are displayed.

3. Turn the [CURSOR] knob to select a menu item.

- If the menu extends across multiple pages, you can move in units of pages by turning the [CURSOR] knob while pressing it.
- If the value area indicates "Enter," you can press the [ENTER] button to proceed to a lower level. Alternatively, pressing the [ENTER] button executes an operation.

4. Turn the [VALUE] knob to change the value of the setting.



* By turning the [VALUE] knob while pressing it, you can change the value more greatly.

- If you hold down the [ENTER] button and press the [VALUE] knob, the selected menu item returns to the default setting.

If you hold down the [ENTER] button and long-press the [VALUE] knob, all menu items in the same level return to the default setting.

5. Press the [MENU] button several times to close the menu.

- Pressing the [MENU] button once takes you back to the previous screen.

MEMO

For details on the menu items, refer to the "Reference Manual" (PDF) which you can download from the Roland website.

<https://proav.roland.com/>

List of Compatible Video Formats

Input Video Formats

Frame Rate	
When set to "59.94 Hz"	When set to "50 Hz"
480/59.94i	576/50i
480/59.94p	576/50p
720/59.94p	720/50p
1080/59.94i	1080/50i
1080/59.94p	1080/50p
800 x 600/60 Hz	800 x 600/60 Hz
1024 x 768/60 Hz	1024 x 768/60 Hz
1280 x 720/60 Hz	1280 x 720/60 Hz
1280 x 800/60 Hz	1280 x 800/60 Hz
1280 x 1024/60 Hz	1280 x 1024/60 Hz
1366 x 768/60 Hz	1366 x 768/60 Hz
1400 x 1050/60 Hz	1400 x 1050/60 Hz
1600 x 1200/60 Hz	1600 x 1200/60 Hz
1920 x 1080/60 Hz	1920 x 1080/60 Hz
1920 x 1200/60 Hz RB	1920 x 1200/60 Hz RB

* The input format is automatically recognized.

Audio input format	HDMI: Linear PCM, 24 bits, 48 kHz, 2 ch
---------------------------	---

Output Video Formats

Frame Rate	
When set to "59.94 Hz"	When set to "50 Hz"
720/59.94p	720/50p
1080/59.94i	1080/50i
1080/59.94p	1080/50p
1024 x 768/60 Hz	1024 x 768/75 Hz
1280 x 720/60 Hz	1280 x 720/75 Hz
1280 x 800/60 Hz	1280 x 800/75 Hz
1280 x 1024/60 Hz	1280 x 1024/75 Hz
1366 x 768/60 Hz	1366 x 768/75 Hz
1400 x 1050/60 Hz	1400 x 1050/75 Hz
1600 x 1200/60 Hz	1600 x 1200/60 Hz
1920 x 1080/60 Hz	1920 x 1080/60 Hz
1920 x 1200/60 Hz RB	1920 x 1200/60 Hz RB

* For details on how to set the output format, refer to "Setting the Output Format" on the next page.

Audio output format	HDMI: Linear PCM, 24 bits, 48 kHz, 2 ch
----------------------------	---

Video Operations

Setting the Output Format

Here's how to specify the output format as appropriate for the devices connected to the XS-1HD.

1. [MENU] button → "Output" → select "Format."

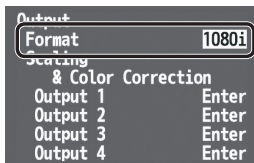

2. Use the [VALUE] knob to select the output format.

* For the output formats supported by the XS-1HD, refer to "Output Video Formats" on the previous page.

3. If the message "Keep output format?" appears, use the [CURSOR] knob to select "Yes," and press the [ENTER] button.

The output format is switched.

4. Press the [MENU] button several times to close the menu.

MEMO

If the screen mode is "switcher mode" (p. 15), the output format of the VIDEO OUTPUT 4 connector is fixed at "1080p/60 Hz."

About frame rate

Frame rates that can be input and output are "59.94 Hz" or "50 Hz."

You can change the frame rate in [MENU] button → "System" → "Frame Rate."

When inputting Computer-resolution video

The refresh rate is "60 Hz" regardless of the frame rate.

When outputting Computer-resolution video

If the frame rate setting is "50 Hz," the refresh rate might be "75 Hz" depending on the output resolution.

Switching Video

Here's how to switch between the video input signals and output the result.

About the Screen Modes

The XS-1HD's video output has three screen modes: matrix, split, and switcher.

Matrix mode (next page)

Use the cross-point buttons to switch the combination of four inputs and four outputs, and output the video. The internal frame synchronizer allows seamless video switching.

Split mode (p. 14)

Up to four screens of the video selected by the cross-point buttons can be layer-composited and output. The video of XPT 1 can also be key-composited.

Switcher mode (p. 15)

The video of the PGM side (XPT3 row) is always output. The PST side (XPT4 row) selects the preset video (the video that will be output next).

Use the [AUTO] button or operate the video fader to switch the video.

* The VIDEO OUTPUT 4 connector outputs a multi-view that lets you check the input video channels 1–4.

MEMO

The current screen mode is shown by the SCREEN MODE indicators.



Switching the screen mode

1. [MENU] button → "System" → select "Screen Mode."

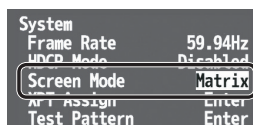

2. Use the [VALUE] knob to set the screen mode to Matrix, Split, or Switcher.
3. Press the [MENU] button several times to close the menu.

Switching in Matrix Mode

Use the cross-point buttons to switch the combination of four inputs and four outputs, and output the video. The internal frame synchronizer allows seamless video switching.

Operating procedure

1. As described in “Switching the screen mode” on the previous page, set the screen mode to Matrix.
2. Use the [TIME] knob to specify the video transition time.

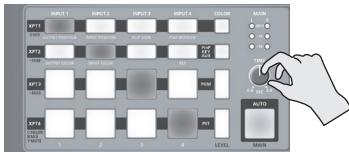

3. Press a cross-point button.

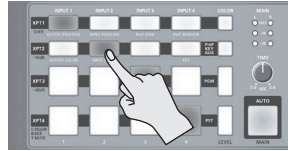

The output video is switched.

MEMO

- You can individually specify the scaling for each video output. [MENU] button → “Output” → “Output 1” – “Output 4” → [ENTER] button → adjust the various Scaling items.
- You can also use the quick edit function to specify the scaling (p. 19).

Output examples

Four outputs

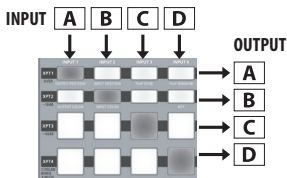

When using four outputs, video transitions are separated by the background color.

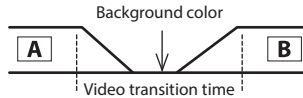

Seamless transitions

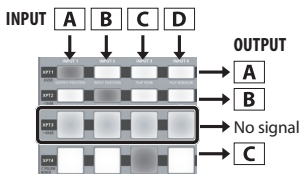

By restricting the outputs, you can perform seamless video transitions that use dissolve.

Restrict to three outputs: Seamless video transition is possible for one screen.

Restrict to two outputs: Seamless video transition is possible for two screens simultaneously.

Settings

[MENU] button → “System” → use “XPT Assign” to turn “Off” the cross-point of the outputs that you want to restrict.

In the example shown at left, the “HDMI 3” cross-point is turned “Off”.

Spanning

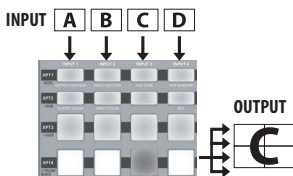

By combining cross-points and outputs, 2–4 screens can be spanned.

Settings

[MENU] button → “System” → use “XPT Assign” to specify the same cross-point for the outputs that you want to span.

In the example shown at left, the cross-points of “HDMI 1” – “HDMI 4” are set to “XPT 4.”

- * By restricting the outputs, you can perform seamless video transitions that use dissolve.

Switching in Split Mode

Up to four screens of the video selected by the cross-point buttons can be layer-composited and output. The video of XPT 1 can also be key-composited.

Operating procedure

1. As described in “Switching the screen mode” (p. 12), set the screen mode to Split.
2. Use the [TIME] knob to specify the video transition time.

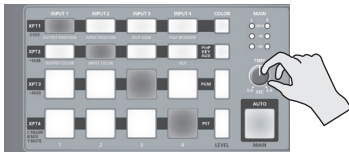

3. Press a cross-point button.

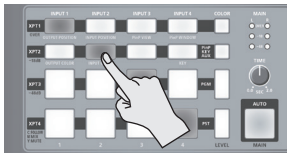

The composited video is switched.

Hiding the layers

1. Press the [COLOR] button of the layer whose video you want to hide. The [COLOR] button is lit red. The [COLOR] button is lit red.
2. To show the video, press the cross-point button of a layer that is hidden.

MEMO

- The order in which layers are overlaid is fixed.

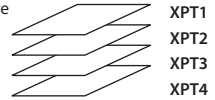

- You can adjust the position and size of the video for each layer. [MENU] button → “Composition” → “XPT 1”-“XPT 4” → [ENTER] button → adjust the various items in the PinP Window.
- If you want to key-composite the video of XPT 1, go to “Composition” → “XPT 1” → [ENTER] button → and set “Key” to “Enabled.” You can also use “Type” to specify the key type (the color that is removed).
- You can also use the quick edit function to adjust the position and size of the video, and the degree to which the key is applied (p. 19).

Output examples

Compositing four screens

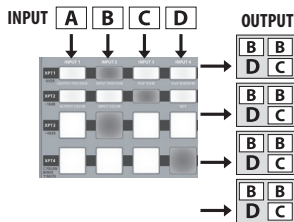

When compositing four screens, video transitions are separated by the background color.

However, if the output format is “1920 x 1200,” the background color setting is disregarded. The fade color will be transparent.

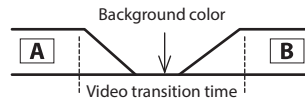

Seamless transitions

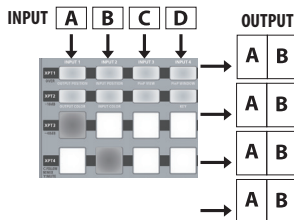

By reducing the number of screens that are composited, you can perform seamless video transitions that use dissolve.

Settings

[MENU] button → “System” → set “XPT Assign” to “Off” for cross-points that you are not using.

In the example shown at left, the cross-points of “HDMI 1” and “HDMI 2” are set to “Off.”

Switching in Switcher Mode

The video of the PGM side (XPT3 row) is always output. The PST side (XPT4 row) selects the preset video (the video that will be output next). Use the [AUTO] button or operate the video fader to switch the video.

Operating procedure

- As described in “Switching the screen mode” (p. 12), set the screen mode to Switcher.
- Move the video fader all the way in one or the other direction.
- Press a PST (XPT4 row) cross-point button to select the preset video (the video that you want to show next).

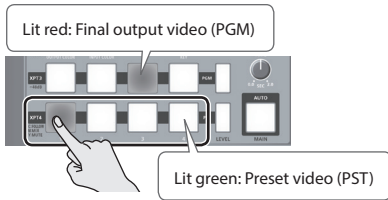

- Use the [TIME] knob to specify the video transition time.



- Press the [AUTO] button.

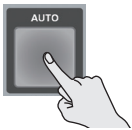

A dissolve effect is applied, and the output video is switched. When the transition between videos is completed, the illumination of the PGM and PST buttons is exchanged.

- When using the video fader to switch, move the video fader in the opposite direction that you did in step 2. When the video fader is moved all the way, the videos are switched completely.

Compositing with PinP or key

Here's how to composite videos using PinP. You can also key-composite the PinP inset video.

- Press the [MENU] button → “Composition” → set “Mode” to “PinP & Key.”
If you want to use key-compositing, set “Composition” → “Setup” → “Key” to “Enabled.” Also set “Type” to specify the key type (the color to be removed).
- Press a cross-point button in the XPT2 row to select the video that will be the inset screen. The color in which the button is lit indicates the output destination of the composited result.

Lit green	Preview output only
Lit red	Final output, preview output

- When you press a cross-point button that is lit green, it changes to being lit red, and the composited result is the final output.
- When you press a cross-point button that is lit red, it changes to being lit green, and the composited result output is only the preview.

MEMO

- To adjust the position, size, and keying depth of the inset screen, press the [MENU] button → “Composition” → “Setup” → [ENTER] button → adjust the various PinP Window and Key settings.
- You can also use the quick edit function to adjust the position, size, and keying depth of the inset screen (p. 19).

Using the AUX bus

Here's how you can assign the AUX bus to the VIDEO OUTPUT 3 connector.

- Press the [MENU] button → “Composition” → set “Mode” to “AUX.”
- Press a cross-point button in the XPT2 row to select the video that is sent to the AUX bus.

Output example

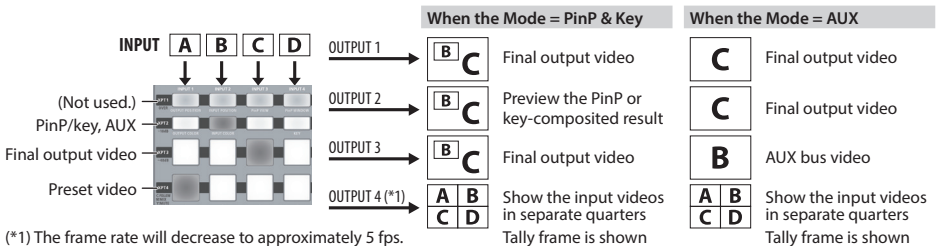

Outputting a Loaded Still Image

A still image that you load from a USB flash drive can be assigned to an input channel, and output in the same way as video.

Supported still image format and resolution

You can load still images of the following file format.

Format	Bitmap (.bmp), 24-bit color, uncompressed
Resolution	Maximum 1920 x 1200 pixels
File name	Eight or fewer single-byte alphanumeric characters * The file extension ".bmp" must be added.

Loading a still image

Here's how to load a still image from a USB flash drive into the XS-1HD.

NOTE

- The XS-1HD temporarily stores only one captured still image.
If a still image is already loaded, loading a new still image overwrites the previously loaded image. The still image is deleted when the power is turned off.
- When using a USB flash drive for the first time, you must format it using the XS-1HD (p. 23).

1. Save the still image in the root directory of the USB flash drive.
2. To the USB MEMORY port, connect the USB flash drive on which the still image is saved.
3. Press the [MENU] button → "File" → Still Image, select "Load" and press the [ENTER] button.

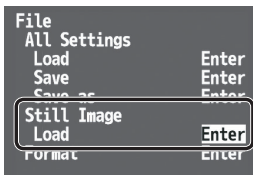

The File ► Load screen appears. The screen shows the names of the files on the USB flash drive.

4. Select the file that you want to load, and press the [ENTER] button.
The still image is loaded into the XS-1HD.
5. When the message "Completed." appears, press the [ENTER] button.
6. Press the [MENU] button several times to close the menu.

Assigning the still image

Here's how to assign the loaded still image to an input channel.

1. Press the [MENU] button → "Input" → select "Input 1"–"Input 4," and press the [ENTER] button.

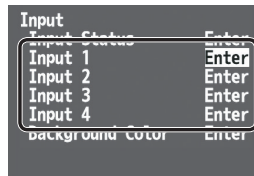

The Input 1–Input 4 screen appears.

2. Select "Input Source" and specify "Still Image."

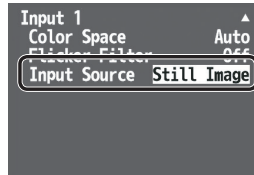

If when switching video, you select the input channel to which "Still Image" is assigned, the still image is output.

3. Press the [MENU] button several times to close the menu.

Fading the Output Video

Here's how to apply a fade to the output video, so that a single color (background color) video is output.

- * This is available when the screen mode is matrix mode (p. 13) or switcher mode (p. 15).
- * Fade operations are not possible while the menu is displayed. Close the menu before performing fades.

1. Press the [COLOR] button of the output channel that you want to fade-out.

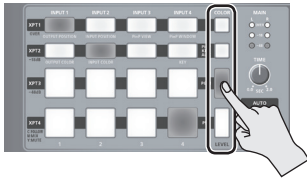

During the fade, the [COLOR] button blinks red. When the fade-out is complete, the [COLOR] button is lit red.

2. To fade-in, press the cross-point button of the output channel that is faded-out.

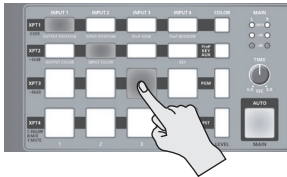

The [COLOR] button blinks, and the video begins to be output. When the fade-in is complete, the [COLOR] button is lit white.

MEMO

- The fade time is specified by the setting of the [TIME] knob.
- You can change the fade color (background color). Press [MENU] button → "Input" → "Background Color" → and adjust "Hue," "Saturation," and "Value." However, if the output format is "1920 x 1200," the background color setting is disregarded. The fade color is fixed at "black."

Inputting Copy-Protected (HDCP) Video

If you want to input HDCP-protected video from a BD player or other device, you can enable HDCP input.

- * If you want to output HDCP-protected video, connect an HDCP-capable display.

1. [MENU] button → "System" → select "HDCP Mode."

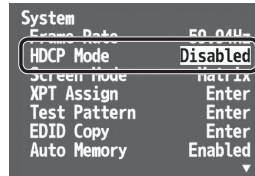

2. Use the [VALUE] knob to specify "Enabled."

Value	Explanation
Enabled	HDCP-protected video can be input. HDCP is applied to the output video.
Disabled	HDCP-protected video cannot be input.

3. Press the [MENU] button several times to close the menu.

MEMO

When HDCP input is enabled, you can check the HDCP status of the source device by pressing the [MENU] button → "Input" → "Input Status" → Input Status screen. The indication "HDCP" is shown for VIDEO INPUT connectors to which HDCP-protected video is being input.

Operation of the HDCP indicator

Regardless of the video input, the HDCP indicator operates as follows.



Indicator	HDCP Mode	Connection status
Lit	Enabled	An HDCP-capable device is connected to a VIDEO OUTPUT connector.
Blinking	Enabled	No HDCP-capable device is connected to a VIDEO OUTPUT connector. Alternatively, a device that is not HDCP-capable is connected.
Unlit	Disabled	—

Audio Operations

You can adjust the volume (Level) of audio that is input or output, and change the state (State) of each channel.

1. Press the [MENU] button → select “Audio” to access the Audio menu.

Page 1/2

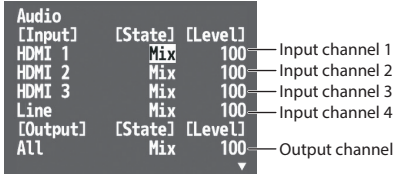

Page 2/2



2. Use the [VALUE] knob to set each menu item.
3. Press the [MENU] button several times to close the menu.

Adjusting the Volume (Level)

1. Select an input channel’s “Level,” and use the [VALUE] knob to adjust the volume of the input audio.

If there is no input audio, or if you’re not using the input audio, set the volume to “0.”

* 100 = 0.0 dB, 127 = +6.0 dB.

2. Select an output channel’s “Level,” and use the [VALUE] knob to adjust the volume of the output audio.

The color of the MAIN level meter indicates whether the volume is adjusted appropriately.

Lit color	Status
Red	Volume is excessive.
Yellow	Volume is appropriate.
Green	Volume is insufficient.



MEMO

- You can also use the quick edit function to change the “State” and “Level” settings (p. 20).
- By using the quick edit function, you can adjust the volume while checking the level of the input audio.

Specifying the State of Each Channel (State)

Muting the Audio (Mute)

Here’s how to temporarily mute the input audio or the output audio (Mute function).

1. Select the “State” of the input or output channel that you want to mute, and use the [VALUE] knob to specify “Mute.”
To cancel muting, set “State” to “Mix.”

Linking Audio Output to Video Switching (Audio Follow)

Here’s how you can link only the specified audio to video switching, and automatically mute other audio.

1. Select the “State” setting of the input channel for which you want to use audio follow, and use the [VALUE] knob to specify “Follow.”
2. Select “Follow XPT,” and specify one of the settings “XPT 1”–“XPT 4.”

* In switcher mode (p. 15), specify one of the settings “XPT 2”–“XPT 4.”

When you use the cross-point button specified in step 2 to switch the video, the audio specified for audio follow is output in tandem with the video transition.

Other audio is automatically muted.

Changing the Audio Source of Input Channel 4

1. Select the “Input” of input channel 4, and use the [VALUE] knob to specify the audio source that will be input.

Value	Explanation
HDMI 4	Input audio from the VIDEO INPUT 4 connector
Line	Input audio from the AUDIO INPUT jacks
Test Tone	Test tone

Matching the Output Timing of the Video and Audio

By delaying the output of the audio, you can match the output timing of the video and audio.

1. Select “Delay Time,” and use the [VALUE] knob to adjust the time by which the audio is delayed.

Other Functions

Using Quick Edit to Adjust Video or Audio

Quick edit is a function that lets you adjust the video or audio from the operation panel without having to display the menu.

Using the Video Quick Edit

You can adjust the input or output video's quality, scaling, and the PinP inset screen's position and size.

The buttons are shortcuts for the following menu items.

XPT1	OUTPUT POSITION	INPUT POSITION	PinP VIEW	PinP WINDOW
XPT2	OUTPUT COLOR	INPUT COLOR	—	KEY

1. Press the [VIDEO] button to turn video quick edit on (lit).
2. Use the cross-point buttons of the XPT1 row and XPT2 row to select the menu item that you want to operate.
The selected button is lit red.
3. Use the cross-point buttons of the XPT4 row to select the input or output channel that you want to operate.
The selected button is lit red.
4. Use the [C1], [C2], and [C3] knobs to adjust the values.
5. To turn off video quick edit, press the [VIDEO] button once again.

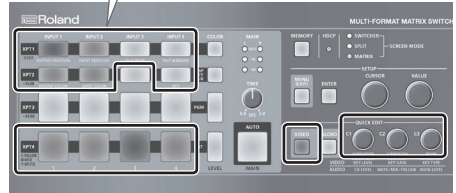

MEMO

- By turning a [C1], [C2], or [C3] knob while pressing it, you can change the value by a larger amount.
- If you hold down the [ENTER] button and press a [C1], [C2], or [C3] knob, the corresponding menu item is reset to the default value.

In matrix mode (p. 13)

XPT1, 2	XPT4	[C1] knob	[C2] knob	[C3] knob
OUTPUT POSITION	Output 1-4	H Position	V Position	Zoom
OUTPUT COLOR		Brightness	Contrast	Saturation
INPUT POSITION	Input 1-4	H Position	V Position	Zoom
INPUT COLOR		Brightness	Contrast	Saturation

In split mode (p. 14) or switcher mode (p. 15)

XPT1, 2	XPT4	[C1] knob	[C2] knob	[C3] knob
OUTPUT POSITION	(no selection)	H Position	V Position	Zoom
OUTPUT COLOR	Output 1-4	Brightness	Contrast	Saturation
INPUT POSITION	Input 1-4	H Position	V Position	Zoom
INPUT COLOR		Brightness	Contrast	Saturation
PinP WINDOW	XPT 1-4 (*1)	H Position	V Position	Zoom
PinP VIEW		H Position	V Position	Zoom
KEY	(no selection)	Level	Gain	Type

(*1) In switcher mode there is no selection.

Other Functions

Using the Audio Quick Edit

You can adjust the volume (Level) of audio that is input or output, and change the state (State) of each channel.

Input audio level meter (dB)

OVER
-18 → Red
-48 → Yellow
-48 → Green

The lit color of the buttons indicates the "State" setting.

Lit color	"State" setting
Magenta	Mix Always output
Cyan	Follow Audio follow
Yellow	Mute Muted

Each button is lit in one of three colors according to the value of the "Level" setting.

Lit color	Value
Red	127 (+6 dB)
Yellow	120
Green	110

Red	100 (0 dB)
Yellow	90
Green	80

Red	70
Yellow	60
Green	50

Red	40
Yellow	30
Green	20
Unlit	0

Input channels

1. Press the [AUDIO] button to turn audio quick edit on (lit).
2. Press a cross-point button in the XPT4 row to select the input channel that you want to control. The selected button blinks.
3. Use the [C1] knob to adjust "Level." Cross-point buttons XPT1-3 function as level meter indicators. The current value of the setting is indicated by the color in which the [COLOR] buttons are lit.
4. Use the [C2] knob to change "State" setting. The color in which the cross-point buttons of the XPT4 row are lit indicates the "State" setting.
 - * You can also change "State" by pressing a cross-point button of the XPT4 row.
5. To turn off audio quick edit, press the [AUDIO] button once again.

Output channels

1. Press the [AUDIO] button to turn audio quick edit on (lit).
2. Press the [AUTO] button to select the output channel that you want to operate. The [AUTO] button blinks.
3. Use the [C3] knob to adjust "Level." The current value of the setting is indicated by the color in which the [COLOR] buttons are lit.
4. Use the [C2] knob to change the "State" setting. The color in which the [AUTO] button is lit indicates the "State" setting.
 - * You can also change the "State" by pressing the [AUTO] button.
5. To turn off audio quick edit, press the [AUDIO] button once again.

MEMO

Regardless of the input/output channel selection, the [C3] knob always adjusts the volume of the output audio.

Saving or Recalling Settings (Memory)

The current settings for video and audio, together with the state of the operating panel, can be saved in memory as a set and recalled when necessary. The XS-1HD provides 16 memories.

Memory 1 functions as “last memory.”

With the factory settings, memory 1 functions as “last memory.” When you close the menu or recall a memory, the current settings are automatically saved in memory 1. If you don’t want to use the “last memory” function, press the [MENU] button → “System” → and set “Auto Memory” to “Disabled.”

Saving to a memory

NOTE

If you select memory 1 as the save-destination, the saved content might be overwritten by the “last memory” function.

1. Long-press the [MEMORY] button to turn the memory function on (lit red).

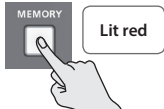

At this time, the cross-point buttons function as memory select buttons. Memory numbers are assigned to the buttons as follows.

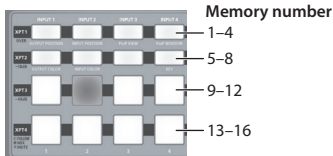

The currently selected cross-point button is lit red.

- * Cross-point buttons in which a memory is saved are lit white.
2. Press the cross-point button of the memory number in which you want to save the settings. The cross-point button is lit red, and the current settings are saved in that memory.
 3. To turn off the memory function, press the [MEMORY] button once again.

Recalling a memory

When the XS-1HD starts up, memory 1 is always loaded.

1. Press the [MEMORY] button to turn the memory function on (lit green).

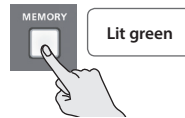

The currently selected cross-point button is lit green.

- * Cross-point buttons in which a memory is saved are lit white.

2. Press the cross-point button of the memory number whose settings you want to recall. The cross-point button is lit green, and the settings are recalled.
3. To turn off the memory function, press the [MEMORY] button once again.

MEMO

Of the settings in the System menu, the following settings are not saved in a memory. Only one set of these settings is saved for the entire XS-1HD. When you edit these settings, they are saved in the XS-1HD when you close the menu.

- Frame Rate
- Auto Memory
- Auto Power Off
- Remote Baudrate
- LED Dimmer

Saving the XS-1HD's Settings as a File on a USB Flash Drive

The XS-1HD's memories (1–16) can be saved together as a single file on a USB flash drive connected to the USB MEMORY port. A saved file can be loaded into the XS-1HD from the USB flash drive when necessary.

Folder structure

When you save the XS-1HD's settings, a folder is created on the USB flash drive. The created folder contains the XS-1HD's settings as a file.

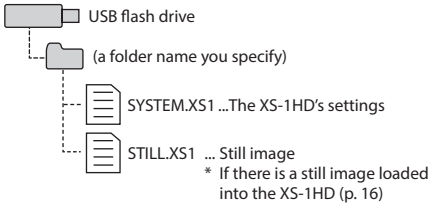

NOTE

- When using a USB flash drive for the first time, you must format it using the XS-1HD (p. 23).
- Never turn off the power or remove the USB flash drive while the message "Processing." is shown.

Overwrite-saving a settings file

1. Press the [MENU] button → "File" → in All Settings, select "Save" and press the [ENTER] button. The File ► Save screen appears.
2. Select a folder and press the [ENTER] button. The file is overwrite-saved.
3. When the message "Completed." appears, press the [ENTER] button.
4. Press the [MENU] button several times to close the menu.

Saving a new settings file

1. Press the [MENU] button → "File" → in All Settings, select "Save as" and press the [ENTER] button.

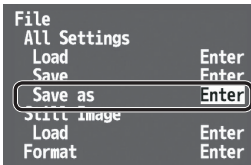

The File ► Save as screen appears.

2. Specify a folder name, and press the [ENTER] button.

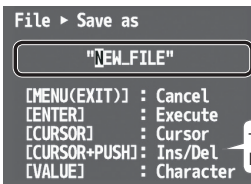

Turn the [CURSOR] knob while pressing it.

A folder is created on the USB flash drive, and files are newly created within that folder.

* If you use your computer to edit the folder name, lowercase characters are converted to uppercase when displayed.

3. When the message "Completed." appears, press the [ENTER] button.
4. Press the [MENU] button several times to close the menu.

Recalling

Here's how to recall XS-1HD settings that you saved on a USB flash drive. When you recall settings, the contents of the XS-1HD's memory are overwritten.

1. Press the [MENU] button → "File" → in All Settings, select "Load" and press the [ENTER] button.

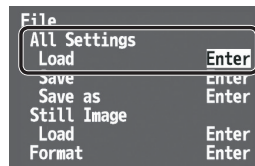

The File ► Load screen appears.

2. Select the folder in which the file that you want to recall is saved, and press the [ENTER] button. The settings are recalled, overwriting the contents of the XS-1HD's memory.
3. When the message "Completed." appears, press the [ENTER] button.
4. Press the [MENU] button several times to close the menu.

Formatting a USB Flash Drive

The first time that you use a USB flash drive, you must use the XS-1HD to format it.

NOTE

- A USB flash drive that was not formatted by the XS-1HD will not be recognized.
- Never turn off the power or remove the USB flash drive while the message “Processing.” is shown.
- Use a commercially available USB flash drive or a USB flash drive sold by Roland. However, we cannot guarantee that all commercially available USB flash drives will work with this unit.
- When you format a USB flash drive, all data on that USB flash drive is erased. If the drive contains important data, back it up to your computer before you format the drive.

Connecting

1. Connect the USB flash drive to the USB MEMORY port.

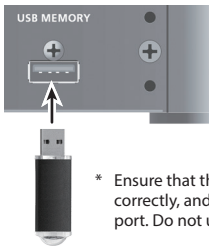

* Ensure that the USB flash drive is oriented correctly, and insert it all the way into the port. Do not use excessive force.

Formatting

1. Press the [MENU] button → “File” → select “Format” and press the [ENTER] button.



2. If the message “USB Memory Format” appears, use the [CURSOR] knob to select “Execute,” and press the [ENTER] button.
The USB flash drive is formatted.
3. When the message “Completed.” appears, press the [ENTER] button.
4. Press the [MENU] button several times to close the menu.

Returning to the Factory Settings (Factory Reset)

Here’s how you can return the settings of the XS-1HD to their factory-set state. If following the procedures described in this manual does not cause the result you expect, try executing a factory reset.

NOTE

When you execute a factory reset, all of the settings you made and the settings you saved in memory (p. 21) are lost.

1. Press the [MENU] button → “System” → select “Factory Reset” and press the [ENTER] button.

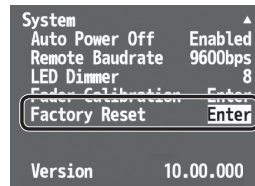

2. If the message “Factory Reset” appears, use the [CURSOR] knob to select “Execute,” and press the [ENTER] button.
Factory reset is executed.
3. When the message “Completed.” appears, press the [ENTER] button.
4. Press the [MENU] button several times to close the menu.

Appendices

Block Diagram

Video Section

Matrix mode

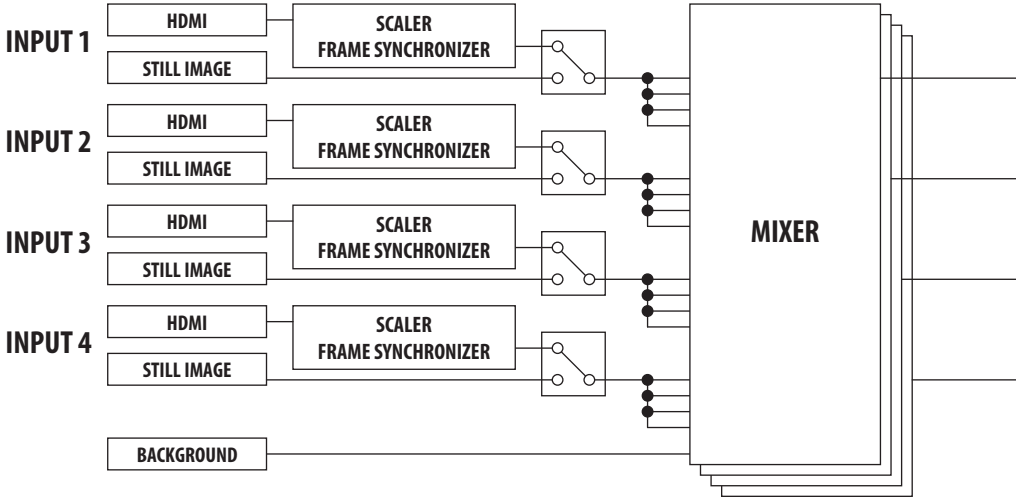

Split mode

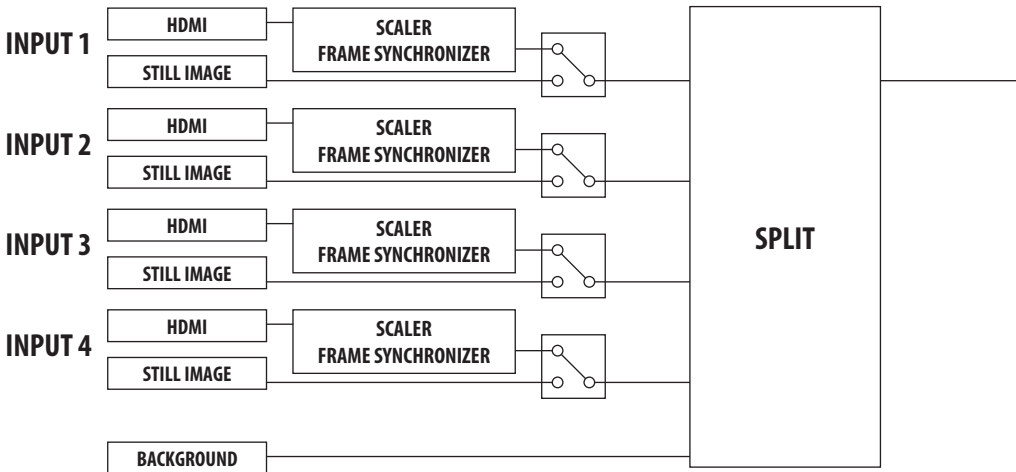

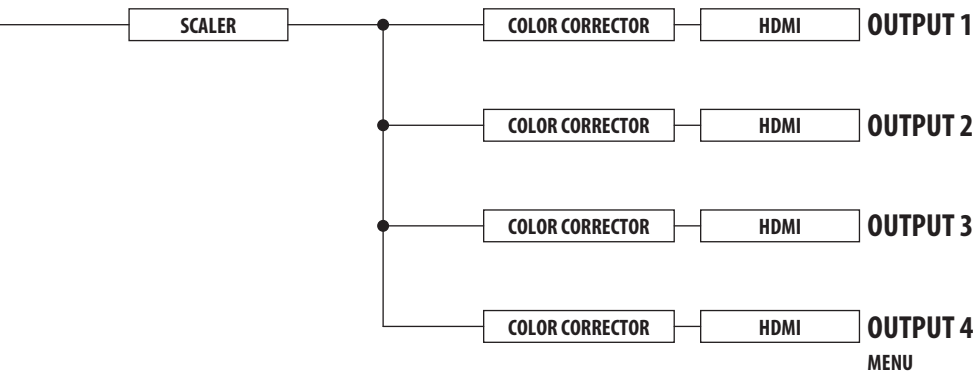
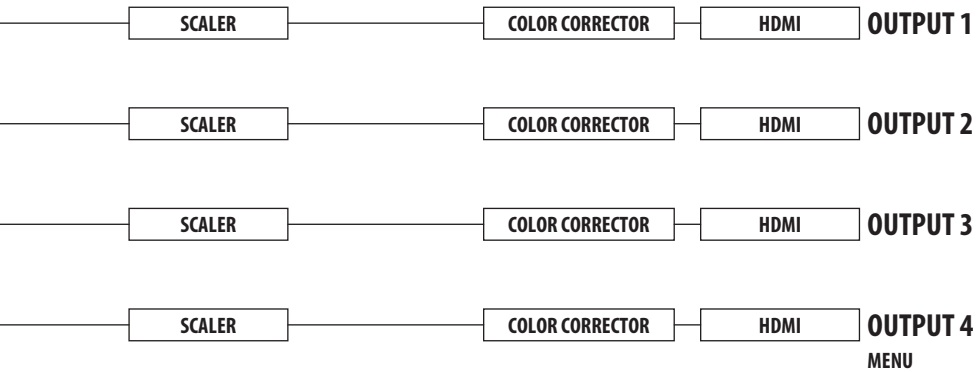

Switcher mode

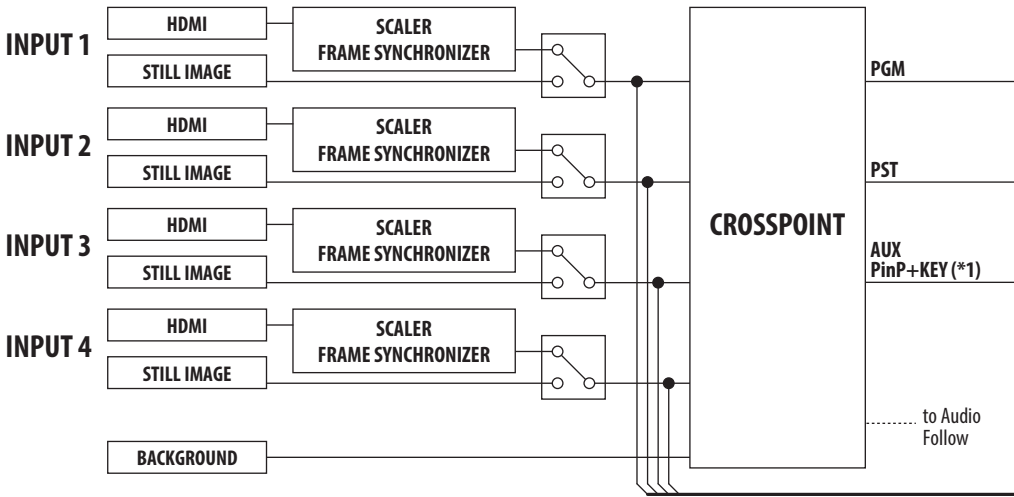

* Still images cannot be scaled.

Audio Section

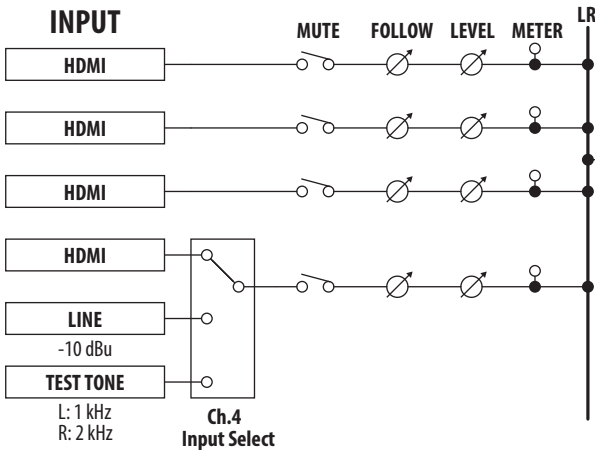

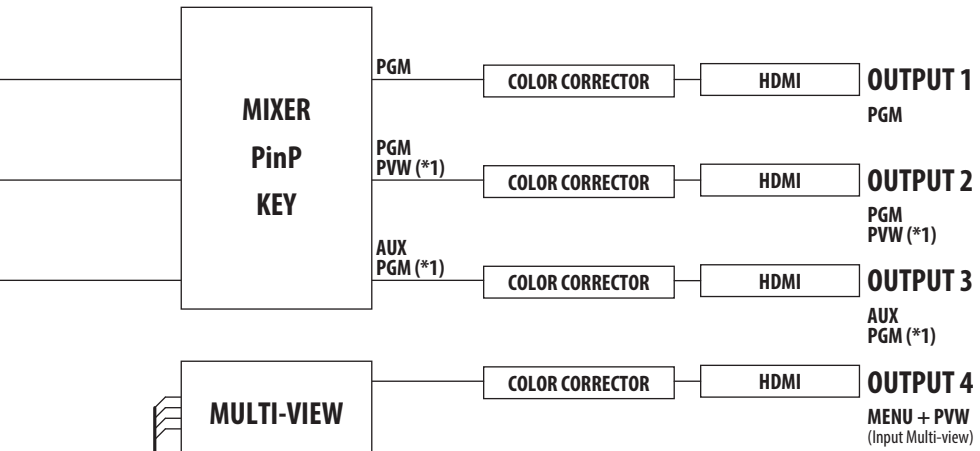

(*1) When the Composition menu's "Mode" is set to "PinP & Key."

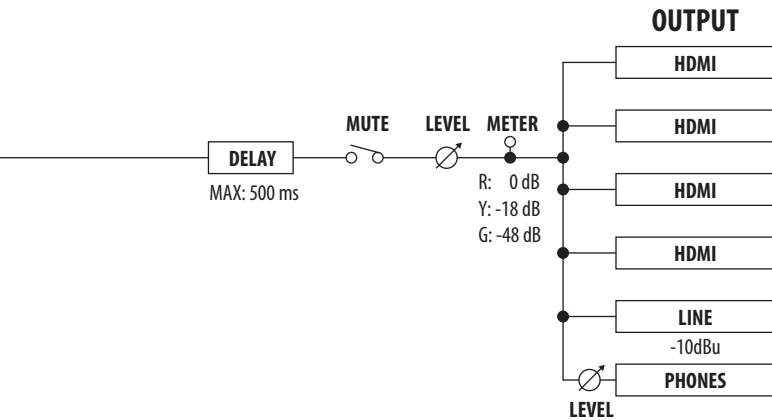

Troubleshooting

If you suspect a malfunction, please check the following points. If this does not resolve the problem, contact a nearby Roland Service Center.

Problem	Check	Action	Page
Problems with video			
Video is not input	Could the cross-point buttons be unlit?	Video of a format not supported by the XS-1HD is being input. If valid video is being input, the cross-point button is lit white.	p. 11
	Could you be inputting copy-protected (HDCP) video?	If you want to input copy-protected (HDCP) video, set the System menu "HDCP" setting to "Enabled."	p. 17
Video is not output	Is the display connected correctly?	If you want to output copy-protected (HDCP) video, connect a HDCP-compliant display.	—
	When using matrix mode, could you have restricted the outputs?	Video is not output from output connectors for which the System menu setting "XPT Assign" is turned "Off." If you want to output video, set "XPT Assign" to one of the settings "XPT 1"~"XPT 4."	p. 13
Nothing is shown on the monitor connected to the VIDEO OUTPUT 4 connector (in switcher mode).	Does the connected monitor support 1920 x 1080/60 Hz (progressive) resolution and refresh rate?	In switcher mode, the VIDEO OUTPUT 4 connector's output format is fixed at "1080p/60 Hz." Connect a monitor that supports 1920 x 1080/60 Hz.	—
"Snowy"-noise video is output.	It might be that the HDMI signal is not being correctly transmitted or received.	Reconnect the HDMI cable.	—
Color is wrong	Do the color space settings of the output-destination device and the XS-1HD match?	Go to Output menu → "Output 1"~"Output 4" → and change the "Color Space" setting.	—
		Depending on the device, the color space might be linked with the DVI/HDMI selection or the selection of format. If so, changing the color space of the output-destination device might solve the problem.	—
An edge of the video shown on a display is cut off	Are the display's settings correct?	Depending on the display, it might overscan automatically. Change the settings of the device.	—
Can't load a still image	Are you loading a still image of a format and resolution supported by the XS-1HD?	Still images of an unsupported format or resolution are not recognized. Make sure that the still image is of a format and resolution that are supported by the XS-1HD.	p. 16
	Is the file name of the still image assigned correctly?	The file name must be no more than eight single-byte characters. Also, the file name extension "*.bmp" must be added. If the file's name is not correct, it is not recognized.	
The video does not switch completely when you operate the video fader (in switcher mode).	Depending on how long the XS-1HD has been used, or on how it has been transported, the video might no longer switch completely.	Execute calibration for the video fader. Move the video fader all the way to the upward position; then select the System menu item "Fader Calibration" and execute it.	—
Can't use a USB flash drive	Has the USB flash drive been formatted by the XS-1HD?	A USB flash drive that was not formatted by the XS-1HD is not recognized. Format the USB flash drive before using it for the first time.	p. 23
Problems with audio			
Audio is not output, or is not loud enough	Could the volume setting of the connected amp or speaker be low?	Adjust the volume appropriately.	—
	Could the volume setting be lowered?	Adjust each input audio setting to the appropriate volume. Also adjust the overall volume.	p. 18
	Could the audio be muted (silenced)?	In the Audio menu, set "State" to "Mix" to cancel muting.	p. 20

Main Specifications Roland XS-1HD: Multi-format Matrix Switcher

■ Video		
Processing	4:4:4 (Y/Pb/Pr, RGB)/10 bits, 4:2:2 (Y/Pb/Pr)/10 bits	
Input Connectors	HDMI	HDMI type A x 4 (HDMI INPUT 1-4) *HDCP Supported
Output Connectors	HDMI	HDMI type A x 4 (HDMI OUTPUT 1-4) *HDCP Supported
Formats	480/59.94i (*1), 576/50i (*1), 480/59.94p (*1), 576/50p (*1), 720/59.94p, 720/50p, 1080/59.94i, 1080/50i, 1080/59.94p, 1080/50p, 800 x 600/60 (*1), 1024 x 768/60 (*2), 1280 x 720/60 (*2), 1280 x 800/60 (*2), 1366 x 768/60 (*2), 1280 x 1024/60 (*2), 1400 x 1050/60 (*2), 1600 x 1200/60, 1920 x 1080/60, 1920 x 1200/60 RB * Conforms to CEA-861-E, VESA DMT Version 1.0 Revision 11 * Frame rate is 59.94 Hz (NTSC) or 50 Hz (PAL). (*1) Input only. (*2) Output refresh rate is 75 Hz when frame rate is set to 50 Hz.	
Effects	Output Mode	Switcher, Split, Matrix
	Transition	Mix, Cut * These effects depend on Output Mode.
	Composition (Keyer)	1 * This effect depends on Output Mode.
	Others	HDCP Supported, Test Pattern Generator.
Still Image	Internal Memory	1
	Maximum Size	1920 x 1200 pixels
	Format	Windows Bitmap File (.bmp) 24 bit per pixel, uncompressed
■ Audio		
Sampling Rate	24 bits/48 kHz	
Input Connectors	HDMI	HDMI type A x 4
	AUDIO INPUT	RCA pin type
Output Connectors	HDMI	HDMI type A x 4
	AUDIO OUTPUT	RCA pin type
	PHONES	Stereo mini type
Input Level	AUDIO INPUT	-10 dBu (Maximum: +8 dBu)
Input Impedance	AUDIO INPUT	15 k ohms
Output Level	AUDIO OUTPUT	-10 dBu (Maximum : +8 dBu)
	PHONES	72 mW + 72 mW (32 ohms)
Output Impedance	AUDIO OUTPUT	1 k ohm
	PHONES	10 ohms
Formats	HDMI	Linear PCM, 24 bits, 48 kHz, 2 ch
Processing	Mixer: 4 ch (Delay: Maximum 500 ms, Audio Follow) Test Tone Generator	
■ Others		
External Connectors	REMOTE	RS-232 DB-9 type (Male) x 1 * for Remote Control
	USB MEMORY	USB A type x 1 (USB Memory)
Preset Memory	16 * Auto Memory Function	
Power Supply	AC Adaptor	
Current Draw	2.1 A	
Power Consumption	25 W	
Operation Temperature	+0 to +40 degrees Celsius	
	+32 to +104 degrees Fahrenheit	
Dimensions	328 (W) x 117 (D) x 57 (H) mm	
	12-15/16 (W) x 4-5/8 (D) x 2-1/4 (H) inches	
Weight	1.2 kg	
	2 lbs 11 oz	
Accessories	Owner's Manual, AC adaptor, Power cord, POWER button cover, Screw (2 pcs)	

* 0 dBu = 0.775 Vrms

* This document explains the specifications of the product at the time that the document was issued. For the latest information, refer to the Roland website.

Dimensions

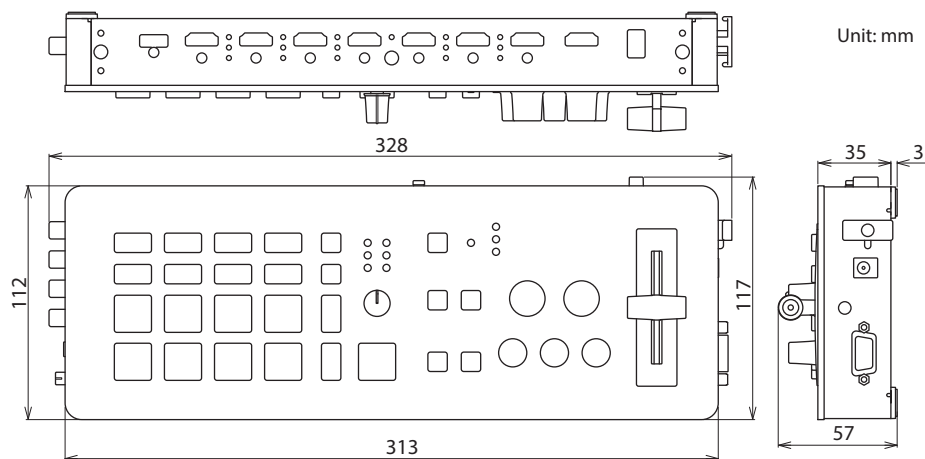

About the POWER Button Cover

By attaching the included POWER button cover, you can prevent the [POWER] button from being pressed inadvertently. You can attach it as necessary.

1. Use the two included screws to fasten the POWER button cover as shown in the illustration.

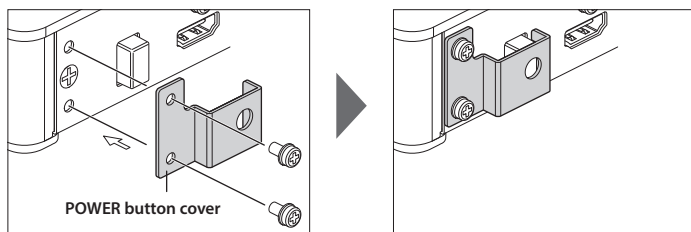

Intellectual Property Right

- It is forbidden by law to make an audio recording, video recording, copy or revision of a third party's copyrighted work (musical work, video work, broadcast, live performance, or other work), whether in whole or in part, and distribute, sell, lease, perform or broadcast it without the permission of the copyright owner.
- Do not use this product for purposes that could infringe on a copyright held by a third party. We assume no responsibility whatsoever with regard to any infringements of third-party copyrights arising through your use of this product.
- This product contains eParts integrated software platform of eSOL Co.,Ltd. eParts is a trademark of eSOL Co., Ltd. in Japan.
- Roland is an either registered trademark or trademark of Roland Corporation in the United States and/or other countries.
- Company names and product names appearing in this document are registered trademarks or trademarks of their respective owners.

For the U.K.

IMPORTANT: THE WIRES IN THIS MAINS LEAD ARE COLOURED IN ACCORDANCE WITH THE FOLLOWING CODE.

BLUE: NEUTRAL
BROWN: LIVE

As the colours of the wires in the mains lead of this apparatus may not correspond with the coloured markings identifying the terminals in your plug, proceed as follows:

The wire which is coloured BLUE must be connected to the terminal which is marked with the letter N or coloured BLACK. The wire which is coloured BROWN must be connected to the terminal which is marked with the letter L or coloured RED. Under no circumstances must either of the above wires be connected to the earth terminal of a three pin plug.

For the USA

DECLARATION OF CONFORMITY Compliance Information Statement

Model Name : XS-1HD
Type of Equipment : VIDEO SWITCHER
Responsible Party : Roland Corporation U.S.
Address : 5100 S. Eastern Avenue Los Angeles, CA 90040-2938
Telephone : (323) 890-3700

For the USA

FEDERAL COMMUNICATIONS COMMISSION RADIO FREQUENCY INTERFERENCE STATEMENT

This equipment has been tested and found to comply with the limits for a Class B digital device, pursuant to Part 15 of the FCC Rules. These limits are designed to provide reasonable protection against harmful interference in a residential installation. This equipment generates, uses, and can radiate radio frequency energy and, if not installed and used in accordance with the instructions, may cause harmful interference to radio communications. However, there is no guarantee that interference will not occur in a particular installation. If this equipment does cause harmful interference to radio or television reception, which can be determined by turning the equipment off and on, the user is encouraged to try to correct the interference by one or more of the following measures:

- Reorient or relocate the receiving antenna.
- Increase the separation between the equipment and receiver.
- Connect the equipment into an outlet on a circuit different from that to which the receiver is connected.
- Consult the dealer or an experienced radio/TV technician for help.

This device complies with Part 15 of the FCC Rules. Operation is subject to the following two conditions:

- (1) this device may not cause harmful interference, and
- (2) this device must accept any interference received, including interference that may cause undesired operation.

This equipment requires shielded interface cables in order to meet FCC class B limit.

Any unauthorized changes or modifications not expressly approved by the party responsible for compliance could void the user's authority to operate the equipment.

For Canada

CAN ICES-3 (B)/NMB-3 (B)

For Korea

사용자 안내문

기종별	사용자 안내문
B 급 기기 (가정용 방송통신기자재)	이 기기는 가정용(B 급) 전자파적합기기로서 주로 가정에서 사용하는 것을 목적으로 하며, 모든지역에서 사용할 수 있습니다.

Manufacturer: 2036-1 Nakagawa, Hosoe-cho, Kita-ku, Hamamatsu, Shizuoka 431-1304, JAPAN
Importer: ENA 23 Zone 1 nr. 1620 Klaus-Michael Kuehnelaan 13, 2440 Geel, BELGIUM



For EU Countries



- UK** This symbol indicates that in EU countries, this product must be collected separately from household waste, as defined in each region. Products bearing this symbol must not be discarded together with household waste.
- DE** Dieses Symbol bedeutet, dass dieses Produkt in EU-Ländern getrennt vom Hausmüll gesammelt werden muss gemäß den regionalen Bestimmungen. Mit diesem Symbol gekennzeichnete Produkte dürfen nicht zusammen mit den Hausmüll entsorgt werden.
- FR** Ce symbole indique que dans les pays de l'Union européenne, ce produit doit être collecté séparément des ordures ménagères selon les directives en vigueur dans chacun de ces pays. Les produits portant ce symbole ne doivent pas être mis au rebut avec les ordures ménagères.
- IT** Questo simbolo indica che nei paesi della Comunità europea questo prodotto deve essere smaltito separatamente dai normali rifiuti domestici, secondo la legislazione in vigore in ciascun paese. I prodotti che riportano questo simbolo non devono essere smaltiti insieme ai rifiuti domestici. Ai sensi dell'art. 13 del D.Lgs. 25 luglio 2005 n. 151.
- ES** Este símbolo indica que en los países de la Unión Europea este producto deberá recogerse aparte de los residuos domésticos, tal como está regulado en cada zona. Los productos con este símbolo no se deben depositar con los residuos domésticos.
- PT** Este símbolo indica que nos países da UE, a recolha deste produto deverá ser feita separadamente do lixo doméstico, de acordo com os regulamentos de cada região. Os produtos que apresentem este símbolo não deverão ser eliminados juntamente com o lixo doméstico.
- NL** Dit symbool geeft aan dat in landen van de EU dit product gescheiden van huishoudelijk afval moet worden aangeboden, zoals bepaald per gemeente of regio. Producten die van dit symbool zijn voorzien, mogen niet samen met huishoudelijk afval worden verwijderd.
- DK** Dette symbol angiver, at i EU-lande skal dette produkt opsamles adskilt fra husholdningsaffald, som defineret i hver enkelt region. Produkter med dette symbol må ikke smides ud sammen med husholdningsaffald.
- NO** Dette symbolet indikerer at produktet må behandles som spesialavfall i EU-land, iht. til retningslinjer for den enkelte regionen, og ikke kastes sammen med vanlig husholdningsavfall. Produkter som er merket med dette symbolet, må ikke kastes sammen med vanlig husholdningsavfall.

- SE** Symbolen anger att i EU-länder måste den här produkten kasseras separat från hushållsavfall, i enlighet med varje regions bestämmelser. Produkter med den här symbolen får inte kasseras tillsammans med hushållsavfall.
- FI** Tämä merkintä ilmaisee, että tuote on EU-maissa kerättävä erillään kotitalousjätteistä kunkin alueen voimassa olevien määräysten mukaisesti. Tällä merkinnällä varustettuja tuotteita ei saa hävittää kotitalousjätteiden mukana.
- HU** Ez a szimbólum azt jelenti, hogy az Európai Unióban ezt a terméket a háztartási hulladéktól elkülönítve, az adott régióban érvényes szabályozás szerint kell gyűjteni. Az ezzel a szimbómmal ellátott termékeket nem szabad a háztartási hulladék közé dobni.
- PL** Symbol oznacza, że zgodnie z regulacjami w odpowiednim regionie, w krajach UE produktu nie należy wyrzucać z odpadami domowymi. Produktów opatrzonych tym symbolem nie można utylizować razem z odpadami domowymi.
- CZ** Tento symbol udává, že v zemích EU musí být tento výrobek sbíráán odděleně od domácího odpadu, jak je určeno pro každý region. Výrobky nesoucí tento symbol se nesmí vyhadzovat spolu s domácími odpady.
- SK** Tento symbol vyjadruje, že v krajinách EÚ sa musí zber tohto produktu vykonávať oddelene od domového odpadu, podľa nariadení platných v konkrétnej krajine. Produkty s týmto symbolom sa nesmú vyhadzovať spolu s domovým odpadom.
- EE** See sümbol näitab, et EL-i maades tuleb see toode olemprügist eraldi koguda, nii nagu on igas piirkonnas määratletud. Selle sümboliga märgitud tooteid ei tohi ära visata koos olemprügiga.
- LT** Šis simbolis rodo, kad ES šalyse šis produktas turi būti surenkamas atskirai nuo buitinių atliekų, kaip nustatyta kiekviename regione. Šiuo simboliu paženklinoti produktai neturi būti išmetami kartu su buitinių atliekomis.
- LV** Šis simbols norāda, ka ES valstīs šo produktu jāievieš atsevišķi no mājsaimniecības atkritumiem, kā noteikts katrā reģionā. Produktais ar šo simbolu nedrīkst izmest kopā ar mājsaimniecības atkritumiem.
- SI** Ta simbol označuje, da je treba proizvod v državah EU zbirati ločeno od gospodinskih odpadkov, tako kot je določeno v vsaki regiji. Proizvoda v tem znakom ni dovoljeno odlagati skupaj z gospodinskimi odpadki.
- GR** Το σύμβολο αυτό υποδηλώνει ότι στις χώρες της Ε.Ε. το συγκεκριμένο προϊόν πρέπει να συλλέγεται χωριστά από τα υπόλοιπα οικιακά απορρίμματα, σύμφωνα με όσα προβλέπονται σε κάθε περιοχή. Τα προϊόντα που φέρουν το συγκεκριμένο σύμβολο δεν πρέπει να απορριπτούν μαζί με τα οικιακά απορρίμματα.

For China

有关产品中所含有害物质的说明

本资料就本公司产品中所含的特定有害物质及其安全性予以说明。
本资料适用于2007年3月1日以后本公司所制造的产品。

环保使用期限



此标志适用于在中国国内销售的电子信息产品，表示环保使用期限的年数。所谓环保使用期限是指在自制造日起的规定期限内，产品中所含的有害物质不致引起环境污染，不会对人身、财产造成严重的不良影响。
环保使用期限仅在遵照产品使用说明书，正确使用产品的条件下才有效。
不当的使用，将会导致有害物质泄漏的危险。

产品中有毒有害物质或元素的名称及含量

部件名称	有毒有害物质或元素					
	铅(Pb)	汞(Hg)	镉(Cd)	六价铬 (Cr(VI))	多溴联苯 (PBB)	多溴二苯醚 (PBDE)
外壳 (壳体)	X	O	O	O	O	O
电子部件 (印刷电路板等)	X	O	X	O	O	O
附件 (电源线、交流适配器等)	X	O	O	O	O	O

O: 表示该有毒有害物质在该部件所有均质材料中的含量均在 SJ/T11363-2006 标准规定的限量要求以下。
X: 表示该有毒有害物质至少在该部件的某一均质材料中的含量超出 SJ/T11363-2006 标准规定的限量要求。
因根据现有的技术水平, 还没有什么物质能够代替它。

