

datavideo



**HDBASET
RECEIVER BOX**

HBT-6

Instruction Manual

www.datavideo.com

Table of Contents

FCC COMPLIANCE STATEMENT	4
WARNINGS AND PRECAUTIONS	4
WARRANTY	6
<i>STANDARD WARRANTY</i>	6
<i>THREE YEAR WARRANTY</i>	7
DISPOSAL	7
1. INTRODUCTION	9
<i>FEATURES</i>	9
2. SYSTEM DIAGRAM	10
3. CONNECTIONS	13
REAR PANEL.....	14
FRONT PANEL.....	15
4. RS-232/RS-422 PINOUT INFORMATION	16
<i>RS-232</i>	16
<i>RS-422</i>	17
5. DIMENSIONS	18
6. SPECIFICATIONS	19

SERVICE AND SUPPORT 20

Disclaimer of Product & Services

The information offered in this instruction manual is intended as a guide only. At all times, Datavideo Technologies will try to give correct, complete and suitable information. However, Datavideo Technologies cannot exclude that some information in this manual, from time to time, may not be correct or may be incomplete. This manual may contain typing errors, omissions or incorrect information. Datavideo Technologies always recommend that you double check the information in this document for accuracy before making any purchase decision or using the product. Datavideo Technologies is not responsible for any omissions or errors, or for any subsequent loss or damage caused by using the information contained within this manual. Further advice on the content of this manual or on the product can be obtained by contacting your local Datavideo Office or dealer.

FCC Compliance Statement

This device complies with part 15 of the FCC rules. Operation is subject to the following two conditions:

- (1) This device may not cause harmful interference, and
- (2) This device must accept any interference received, including interference that may cause undesired operation.

Warnings and Precautions

1. Read all of these warnings and save them for later reference.
2. Follow all warnings and instructions marked on this unit.
3. Unplug this unit from the wall outlet before cleaning. Do not use liquid or aerosol cleaners. Use a damp cloth for cleaning.
4. Do not use this unit in or near water.
5. Do not place this unit on an unstable cart, stand, or table. The unit may fall, causing serious damage.
6. Slots and openings on the cabinet top, back, and bottom are provided for ventilation. To ensure safe and reliable operation of this unit, and to protect it from overheating, do not block or cover these openings. Do not place this unit on a bed, sofa, rug, or similar surface, as the ventilation openings on the bottom of the cabinet will be blocked. This unit should never be placed near or over a heat register or radiator. This unit should not be placed in a built-in installation unless proper ventilation is provided.
7. This product should only be operated from the type of power source indicated on the marking label of the AC adapter. If you are not sure of the type of power available, consult your Datavideo dealer or your local power company.
8. Do not allow anything to rest on the power cord. Do not locate this unit where the power cord will be walked on, rolled over, or otherwise stressed.

9. If an extension cord must be used with this unit, make sure that the total of the ampere ratings on the products plugged into the extension cord do not exceed the extension cord rating.
10. Make sure that the total amperes of all the units that are plugged into a single wall outlet do not exceed 15 amperes.
11. Never push objects of any kind into this unit through the cabinet ventilation slots, as they may touch dangerous voltage points or short out parts that could result in risk of fire or electric shock. Never spill liquid of any kind onto or into this unit.
12. Except as specifically explained elsewhere in this manual, do not attempt to service this product yourself. Opening or removing covers that are marked "Do Not Remove" may expose you to dangerous voltage points or other risks, and will void your warranty. Refer all service issues to qualified service personnel.
13. Unplug this product from the wall outlet and refer to qualified service personnel under the following conditions:
 - a. When the power cord is damaged or frayed;
 - b. When liquid has spilled into the unit;
 - c. When the product has been exposed to rain or water;
 - d. When the product does not operate normally under normal operating conditions. Adjust only those controls that are covered by the operating instructions in this manual; improper adjustment of other controls may result in damage to the unit and may often require extensive work by a qualified technician to restore the unit to normal operation;
 - e. When the product has been dropped or the cabinet has been damaged;
 - f. When the product exhibits a distinct change in performance, indicating a need for service.

Warranty

Standard Warranty

- Datavideo equipment are guaranteed against any manufacturing defects for one year from the date of purchase.
- The original purchase invoice or other documentary evidence should be supplied at the time of any request for repair under warranty.
- The product warranty period begins on the purchase date. If the purchase date is unknown, the product warranty period begins on the thirtieth day after shipment from a Datavideo office.
- All non-Datavideo manufactured products (product without Datavideo logo) have only one year warranty from the date of purchase.
- Damage caused by accident, misuse, unauthorized repairs, sand, grit or water is not covered under warranty.
- Viruses and malware infections on the computer systems are not covered under warranty.
- Any errors that are caused by unauthorized third-party software installations, which are not required by our computer systems, are not covered under warranty.
- All mail or transportation costs including insurance are at the expense of the owner.
- All other claims of any nature are not covered.
- All accessories including headphones, cables, and batteries are not covered under warranty.
- Warranty only valid in the country or region of purchase.
- Your statutory rights are not affected.

Three Year Warranty

- All Datavideo products purchased after July 1st, 2017 are qualified for a free two years extension to the standard warranty, providing the product is registered with Datavideo within 30 days of purchase.
- Certain parts with limited lifetime expectancy such as LCD panels, DVD drives, Hard Drive, Solid State Drive, SD Card, USB Thumb Drive, Lighting, Camera module, PCIe Card are covered for 1 year.
- The three-year warranty must be registered on Datavideo's official website or with your local Datavideo office or one of its authorized distributors within 30 days of purchase.



Disposal

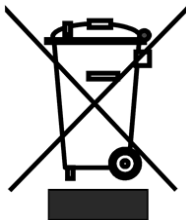

For EU Customers only - WEEE Marking

This symbol on the product or on its packaging indicates that this product must not be disposed of with your other household waste. Instead, it is your responsibility to dispose of your waste equipment by handing it over to a designated collection point for the recycling of waste electrical and electronic equipment. The separate collection and recycling of your waste

equipment at the time of disposal will help to conserve natural resources and ensure that it is recycled in a manner that protects human health and the environment. For more information about where you can drop off your waste equipment for recycling, please contact your local city office, your household waste disposal service or the shop where you purchased the product.



CE Marking is the symbol as shown on the left of this page. The letters "CE" are the abbreviation of French phrase "Conformité Européene" which literally means "European Conformity". The term initially used was "EC Mark" and it was officially replaced by "CE Marking" in the Directive 93/68/EEC in 1993. "CE Marking" is now used in all EU official documents.

1. Introduction

Designed for 4K and 1080p video transmissions, HBT-5 and HBT-6 form an HDBaseT transmitter/receiver set extending transmission distance to 35 meters for 4K video and 60 meters for 1080p video.

With the 48V power connected to the HBT-6 HDBaseT receiver, the HBT-6 will thus be able to power its counterpart by Power over Ethernet (PoE). On the transmitter end (HBT-5), there is also a 12V/24W DC output serving to supply power to backend devices such as cameras.

Furthermore, the RS-232/RS-422 control protocols allow the user to control devices at the transmitter end from the receiver end.

Features

- Transmits HDMI Deep Color, Full 3D and 4K@30 videos
- Extends video transmission to 60m for 1080p video and 35m for 4K@30 video
- Transmits video, audio, Ethernet control, RS-422/232 and PoE over a single Cat.5e/6/6a/7 cable
- Connect 48V power to the HBT-6 Receiver to enable PoE
- 12V 24W DC output powering connected device from HBT-5
- RS-422/232 Control Protocol supports
- HDCP Compliant
- Pass-through EDID passes signal between the source and the display
- Dolby TrueHD & DTS Master audio support

2. System Diagram

1080p@60 up to 60 meters (198 ft) using CAT6 cable

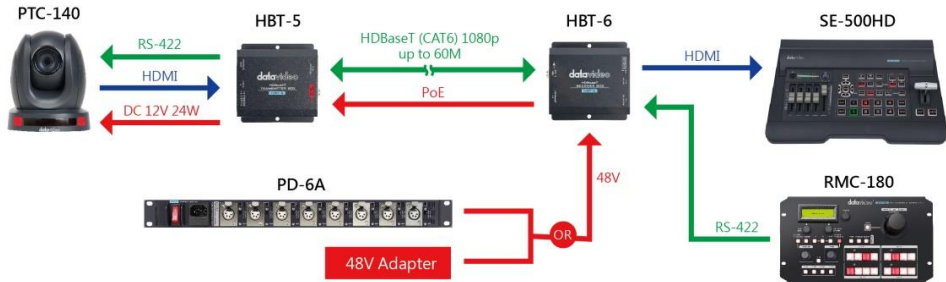

4K@30 up to 35 meters (114 ft) using CAT6 cable

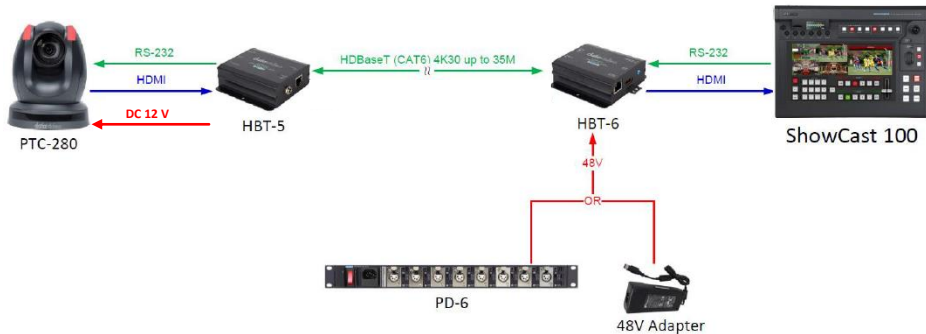

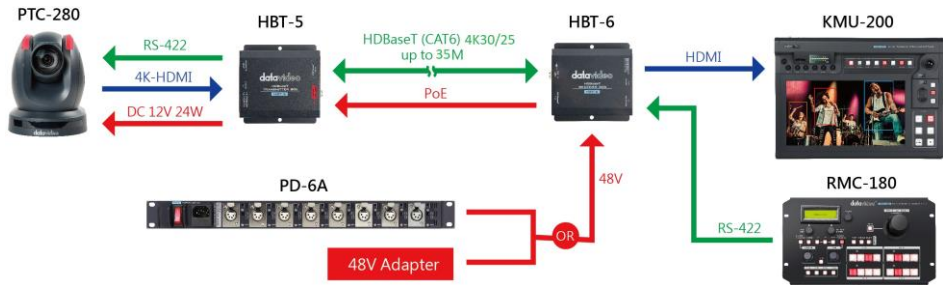

3. Connections

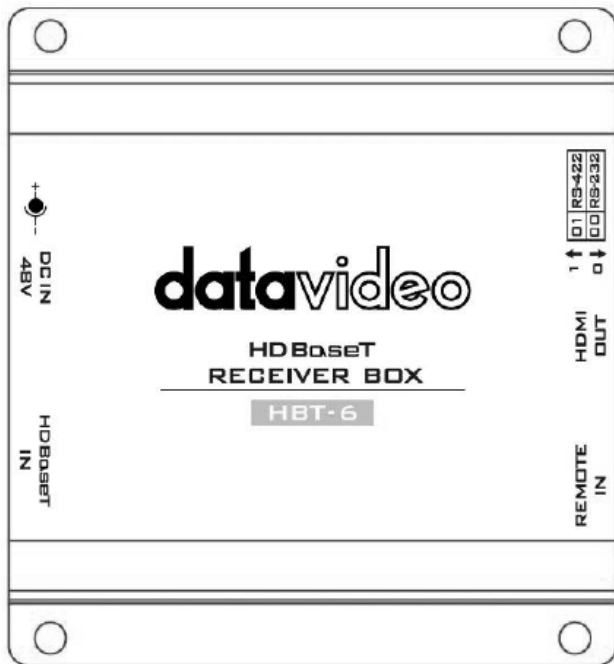

Rear Panel

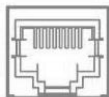
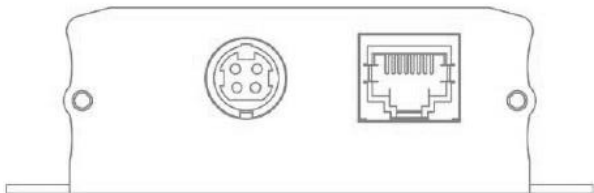

HDBaseT IN

HDBaseT Port

Connect to HDBaseT OUT of the HBT-5 transmitter in 4K mode (60m@1080p60 or 35m@4K2K30).

Note: In addition to HBT-5, the HBT-6 can also receive video delivered from HBT-10 in 4K mode (60m@1080p60 or 35m@4K2K30). If you experience any problem while connecting, please contact the local Datavideo sales office or distributors.



**DC IN
48V**

48V Phantom Power

48V DC power input connection to enable Power over Ethernet (PoE).

Front Panel

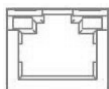
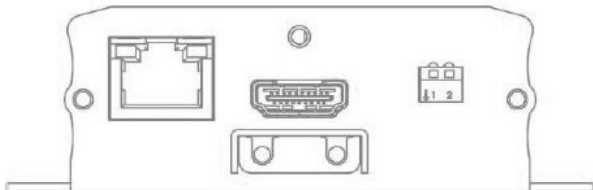

Remote IN

RS-232/RS-422 Interface (RJ-45)

The receiver box has built-in RS-232/RS-422 control protocols that allow the user to control devices at the transmitter end from the receiver end.

Connect external devices via the RS-232 or RS-422 interface (remote IN port).



DIP Switch

Use the DIP switch to switch between RS-232 (00) and RS-422 modes (01).

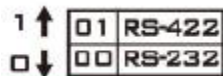

Note: See [RS-232/RS-422 Pinout Information](#) for cabling details and [System Diagram](#) for device setup.

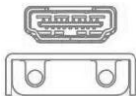

HDMI OUT

HDMI port for video output.

4. RS-232/RS-422 Pinout Information

You may connect external devices such as the switcher to the HBT-6 via RS-232 or RS-422 interface. See below for the respective connection wiring schemes.

RS-232

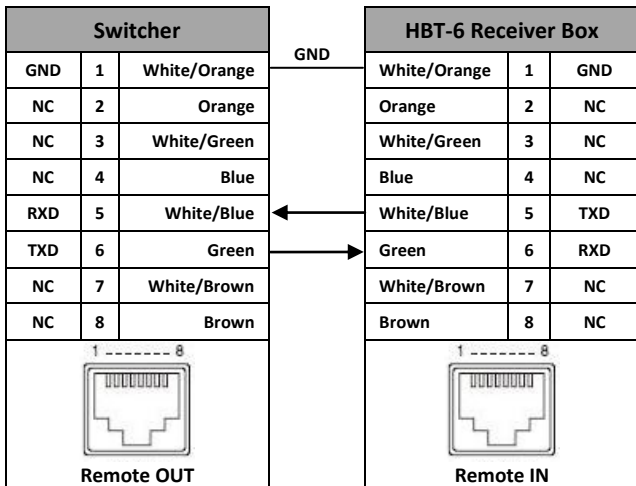

RS-422

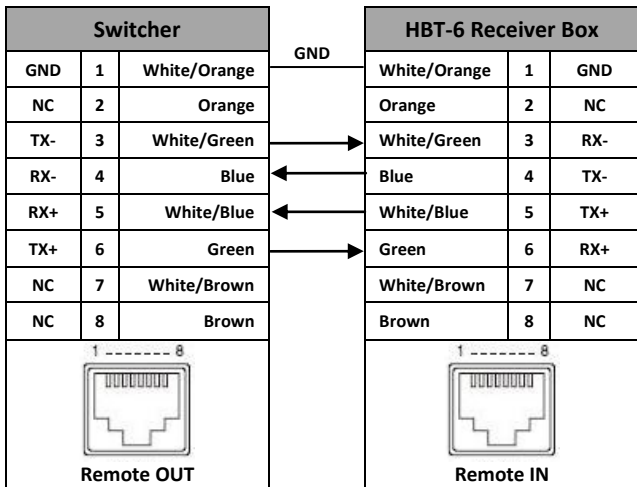

5. Dimensions

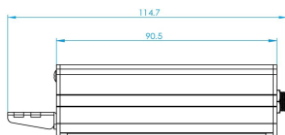
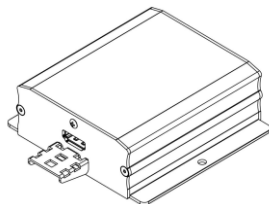
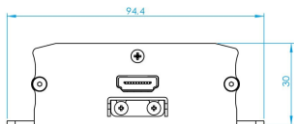
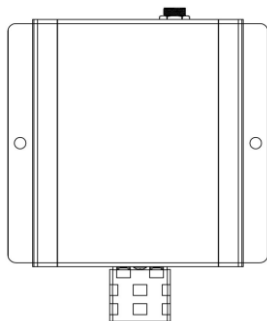

All measurements in millimeters (mm)

6. Specifications

Model Name	HBT-6
Product Name	HDBaseT Receiver Box
Video/Audio Input	HDMI x 1
Video/Audio Output	HDBaseT RJ-45 x 1
Power	DC 12V
HDBaseT Distance	1080p@60 60m (198ft) by CAT6 cable 4K2K@30 35m (114ft) by CAT6 cable
Dimensions (LxWxH)	88 x 76 x 30
Weight	154 g
Operating Temperature	0 – 40 °C

Service & Support

It is our goal to make your products ownership a satisfying experience. Our supporting staff is available to assist you in setting up and operating your system. Please refer to our web site www.datavideo.com for answers to common questions, support requests or contact your local office below.



Please visit our website for latest manual update.

www.datavideo.com/product/HBT-6

datavideo
www.datavideo.com



@DatavideoUSA @DatavideoIndia2016
@DatavideoEMEA @Datavideojapan
@DatavideoTaiwan @DatavideoLatam
@DatavideoAsia @DatavideoBrasil



@Datavideo
@Datavideo_EMEA
@Datavideo_Taiwan



@DatavideoUSA
@DVTWDVCN



@DatavideoUSA
@DatavideoEurope

All the trademarks are the properties of their respective owners.
Datavideo Technologies Co., Ltd. All rights reserved 2020