



LP4390F-B

Manual de usuario

SOPORTE DE PARED PARA PANTALLAS
VESA: 200x200, 300x200, 300x300, 400x200,
400x300, 400x400, 600x400, 800x400

43"-90" |  3kg

Contenido

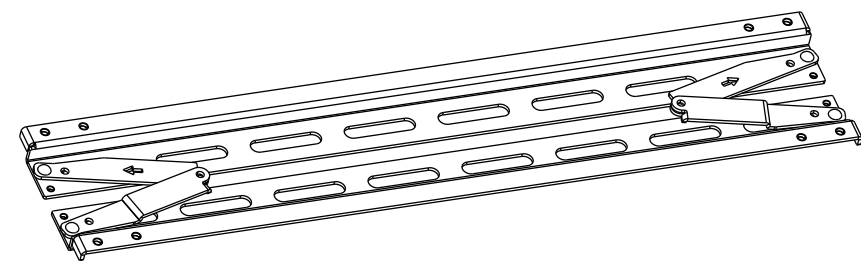

A (x2)

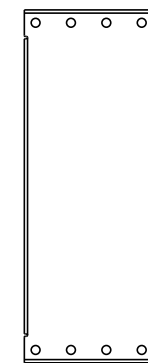

B (x1)

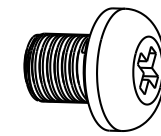

C (x8)

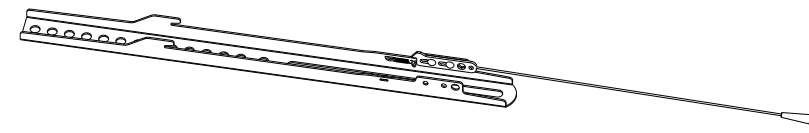

D (x2)

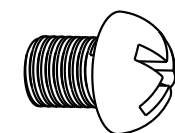

E (x8)

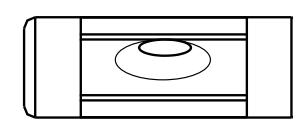

F (x1)

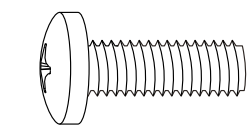

M5x14 (x4)
M-A

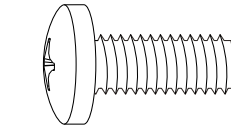

M6x14 (x4)
M-B

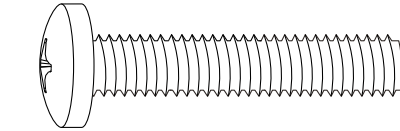

M6x30 (x4)
M-C

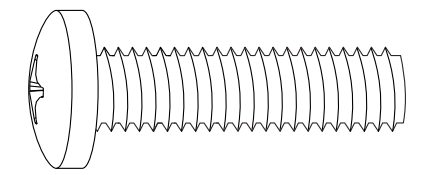

M8x30 (x4)
M-D

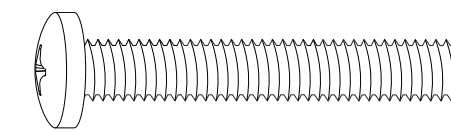

M8x50 (x4)
M-E

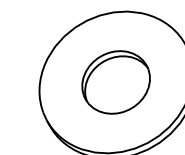

D5 (x4)
M-F

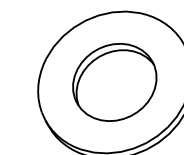

D8 (x4)
M-G

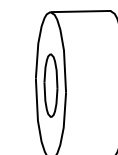

M-H (x8)

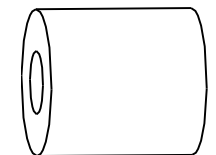

M-I (x8)

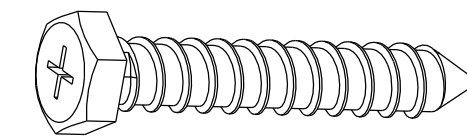

W-A (x6)

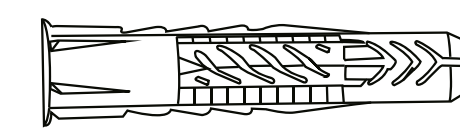

UX8*50R (x6)
W-B

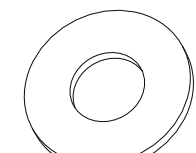

W-C (x6)

Herramientas necesarias

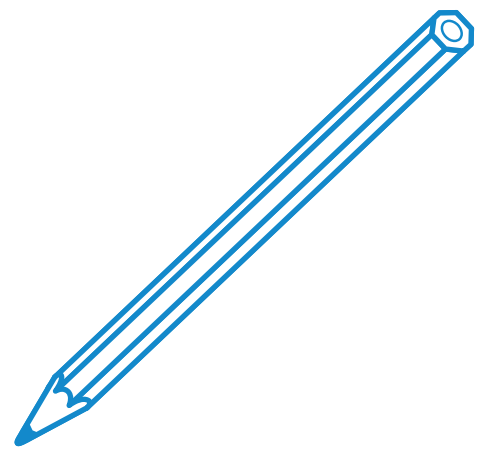

Lápiz

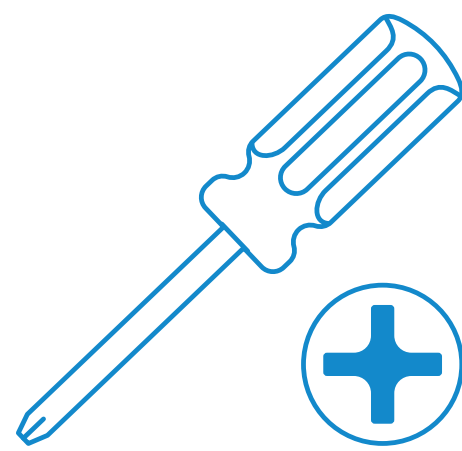

Destornillador

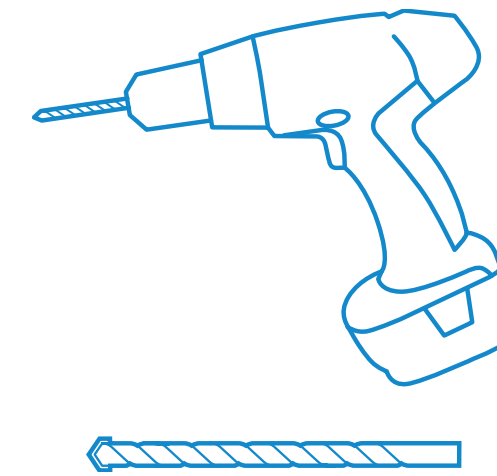

Taladro

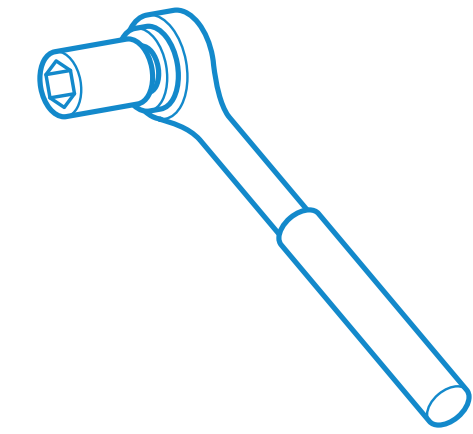

Llave de
carraca

*Herramientas no incluidas en el paquete.

Antes de comenzar la instalación

- Lea el manual de instrucciones, si tiene alguna duda respecto a las instrucciones o advertencias, comuníquese con su distribuidor local.
- Asegúrese de haber recibido todas las piezas según la lista de verificación de componentes para la instalación. Si falta alguna pieza o es defectuosa comuníquese con su distribuidor local.



- La instalación de productos de mayor peso al indicado puede ocasionar inestabilidad y posibles lesiones personales.
- Los soportes deben ensamblarse tal como se especifica en las instrucciones de montaje. Una instalación incorrecta puede ocasionar fallos en el producto y serias lesiones personales.
- Se debe usar material de seguridad y herramientas adecuadas. Este producto solo debe ser instalado por profesionales.
- Asegúrese de que la superficie de fijación puede aguantar de manera segura el peso total del equipo y todos sus componentes.
- Use los tornillos de montaje suministrados y **NO LOS APRIETE DEMASIADO**.
- Este producto contiene piezas pequeñas que podrían ser un peligro de asfixia si se ingiere. Mantenga estos productos lejos de los niños.
- Este producto está destinado solo para uso en interiores. Su uso en el exterior no solo dañará el producto sino que también puede ocasionar lesiones personales.
- Consulte [aquí](#) la garantía del producto.

Instalación

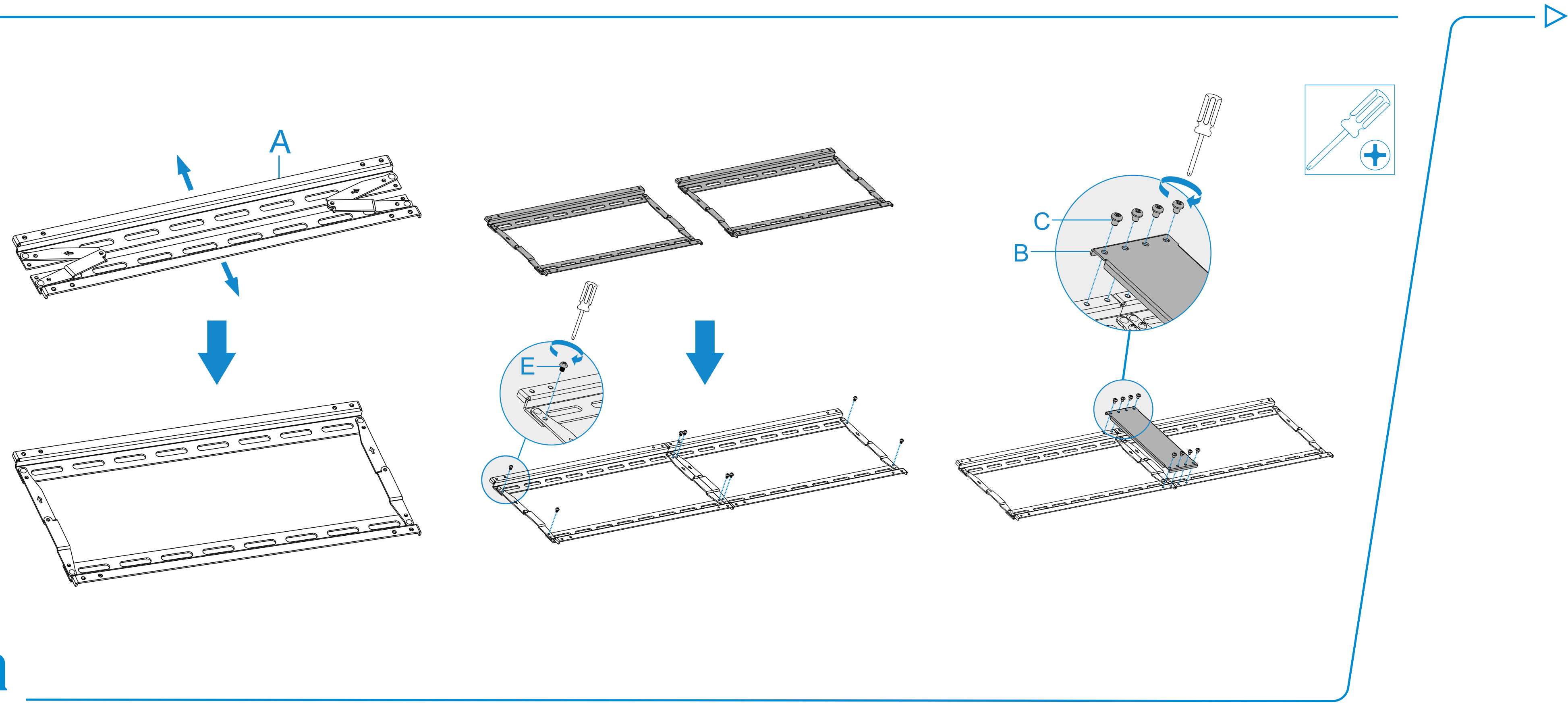

Instalación

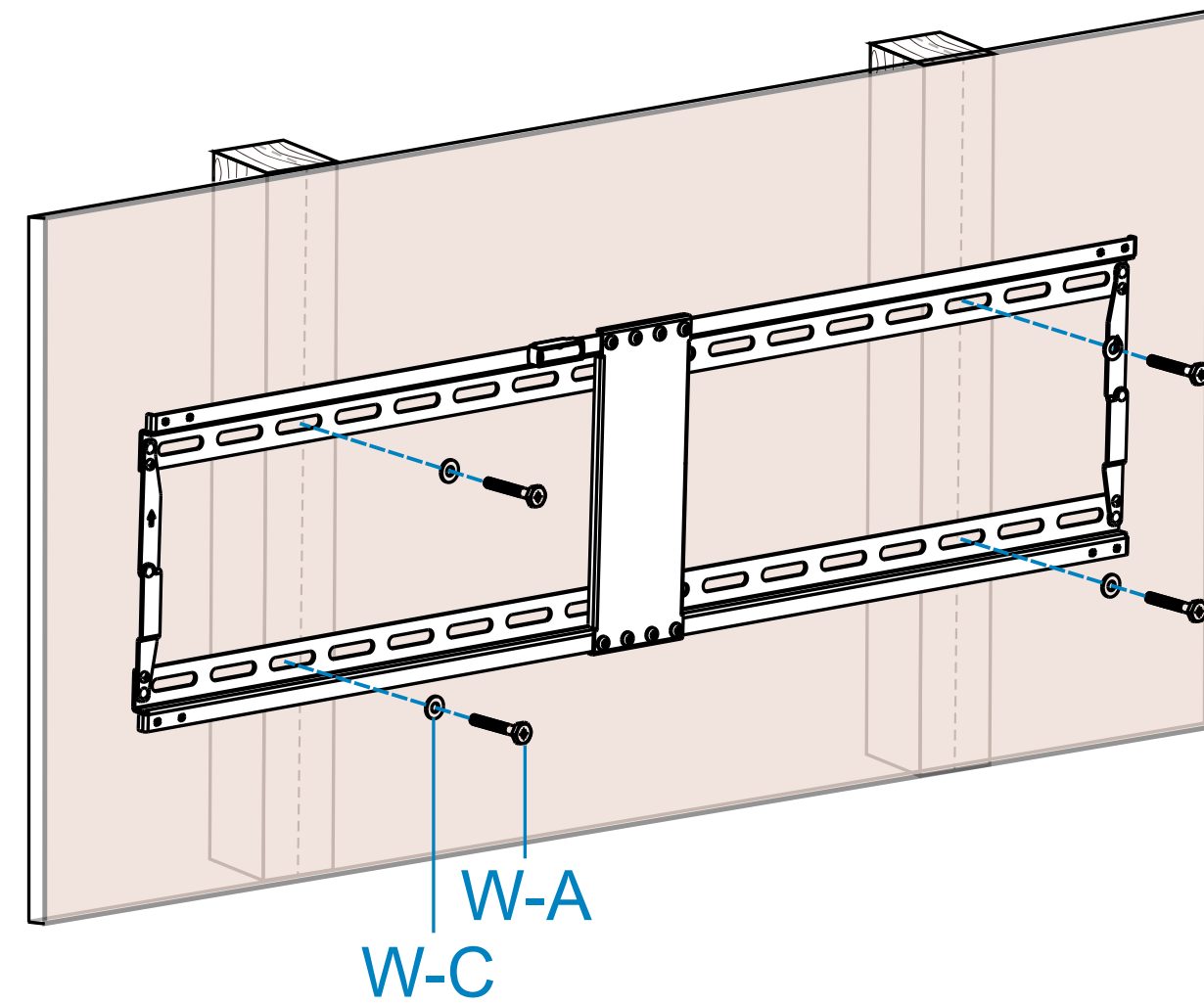
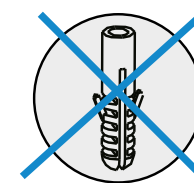
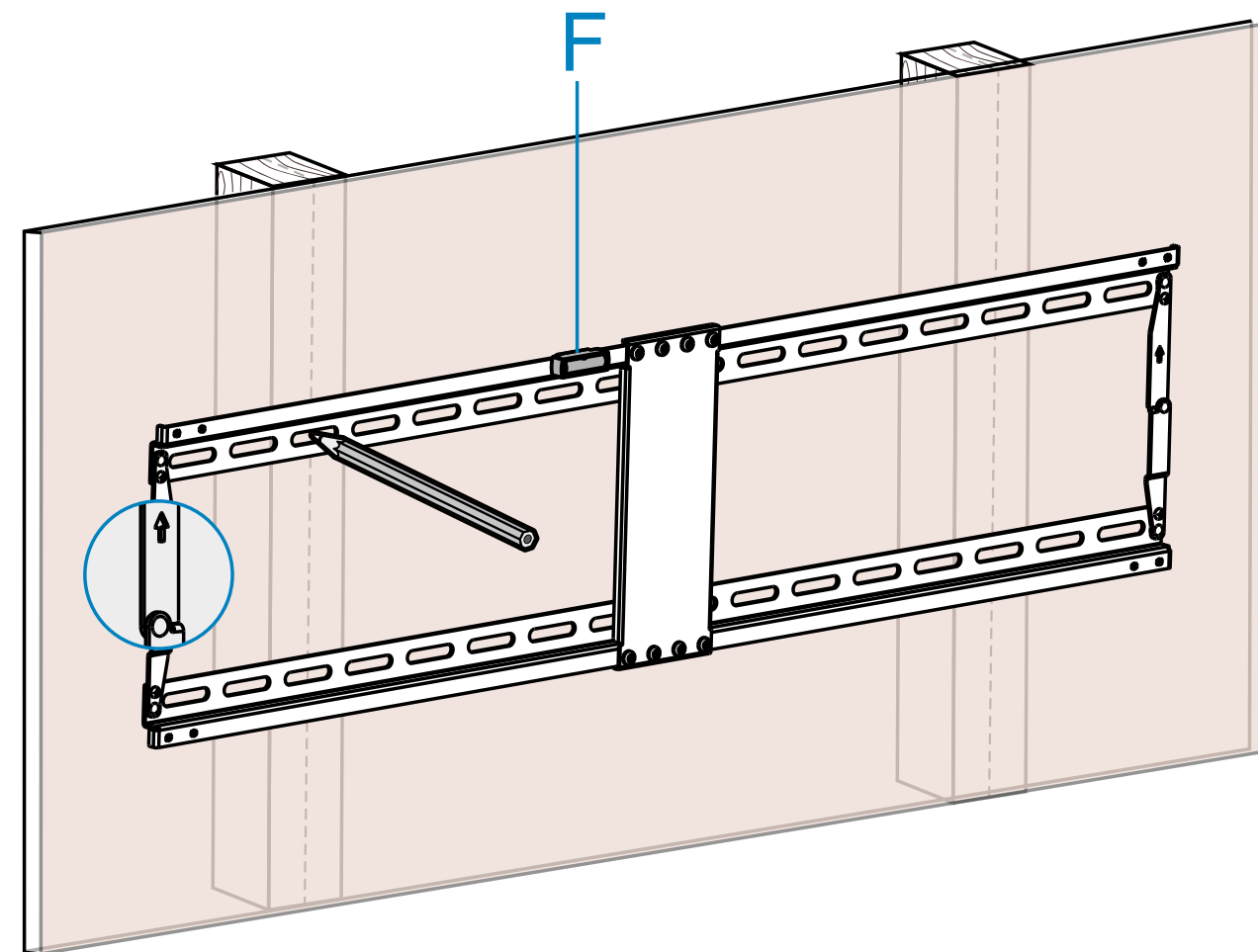
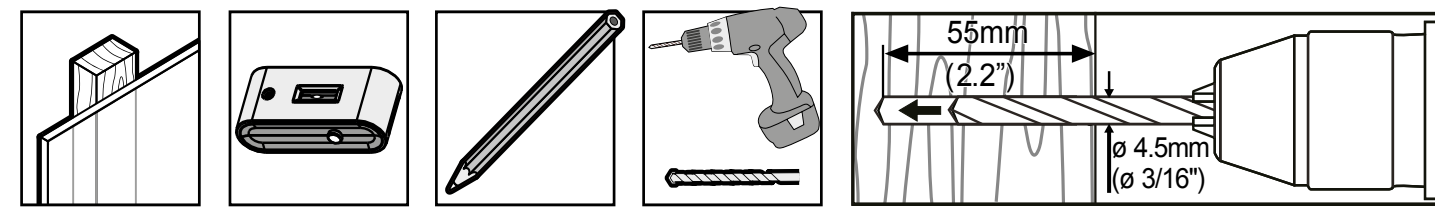

2a

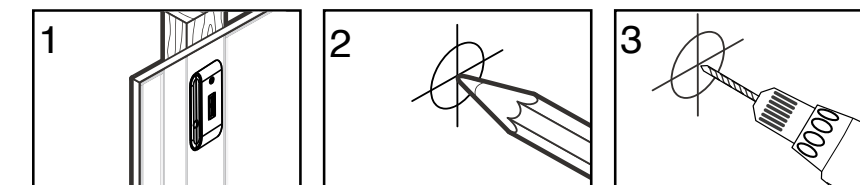
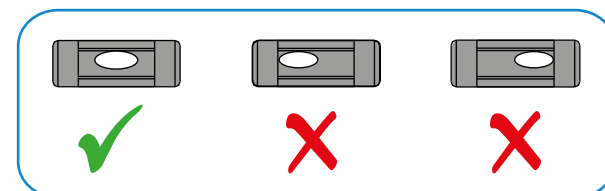

Instalación

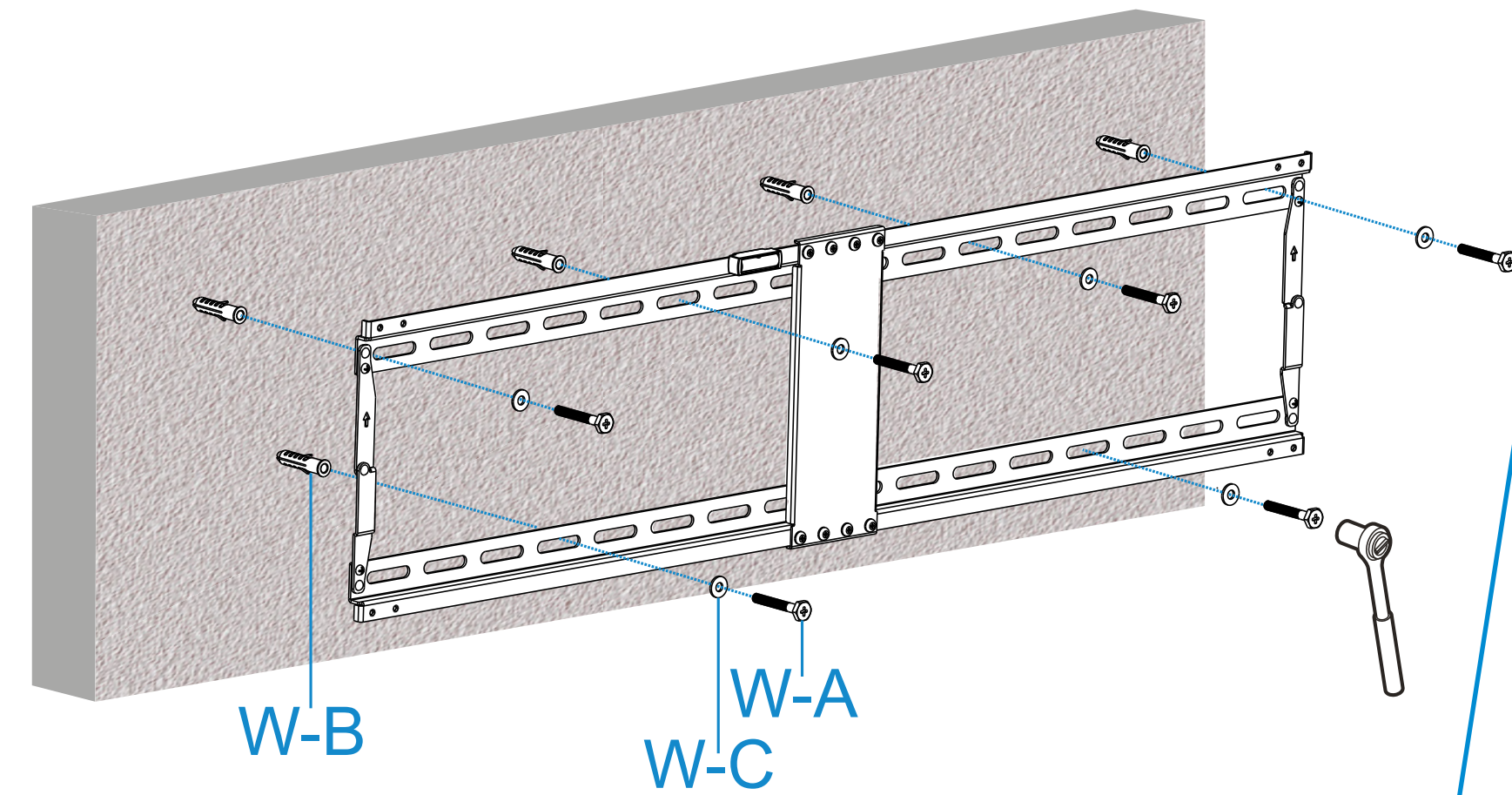
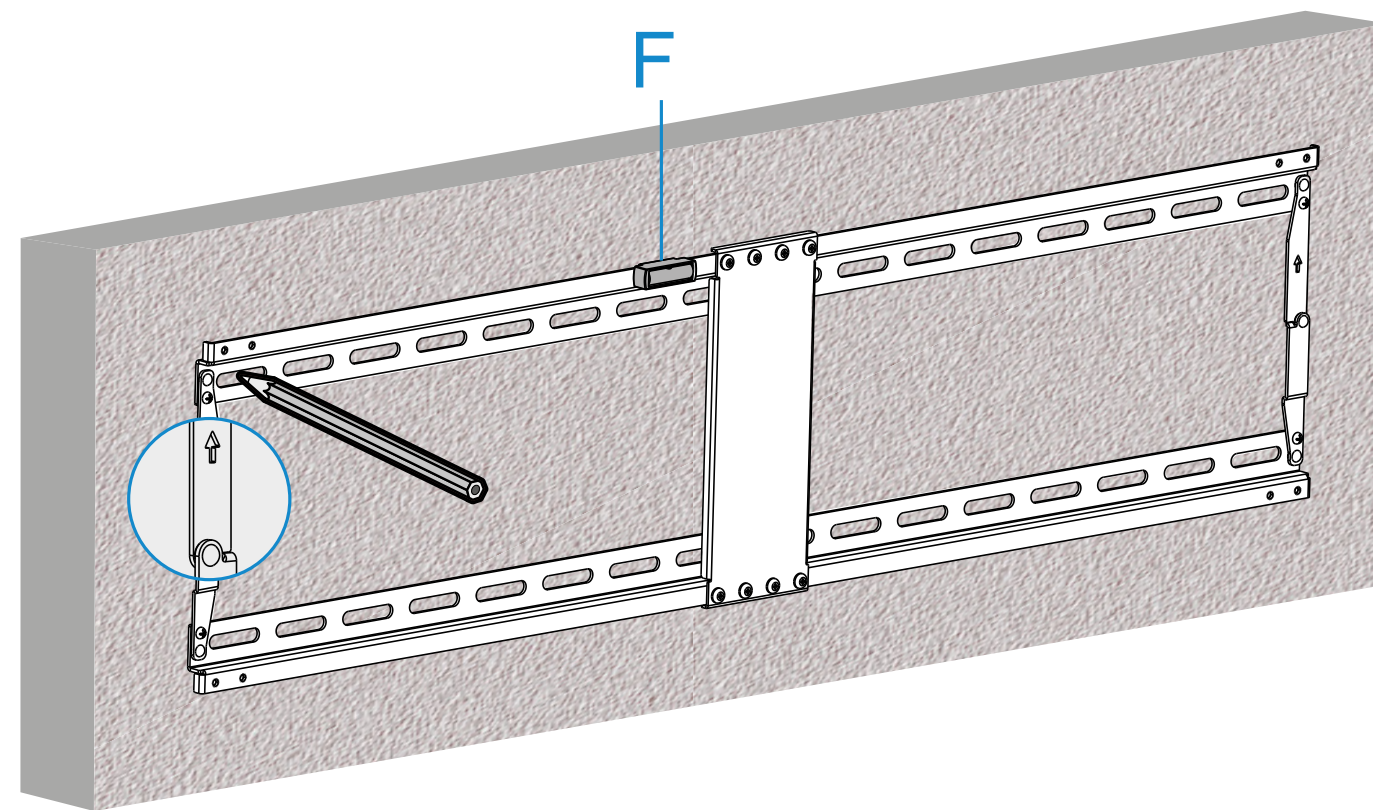
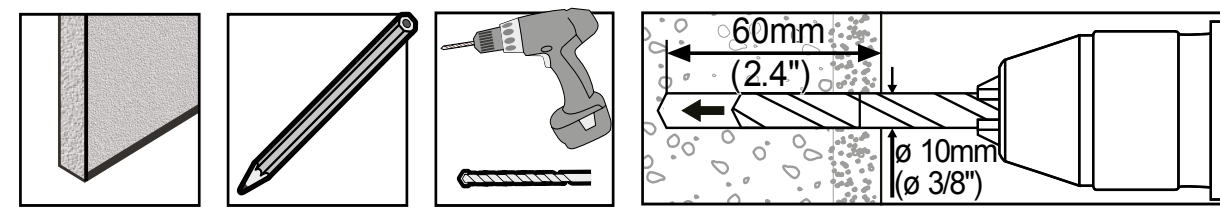

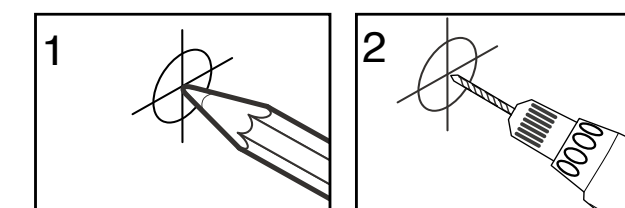
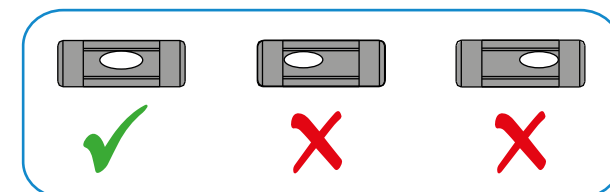

2b



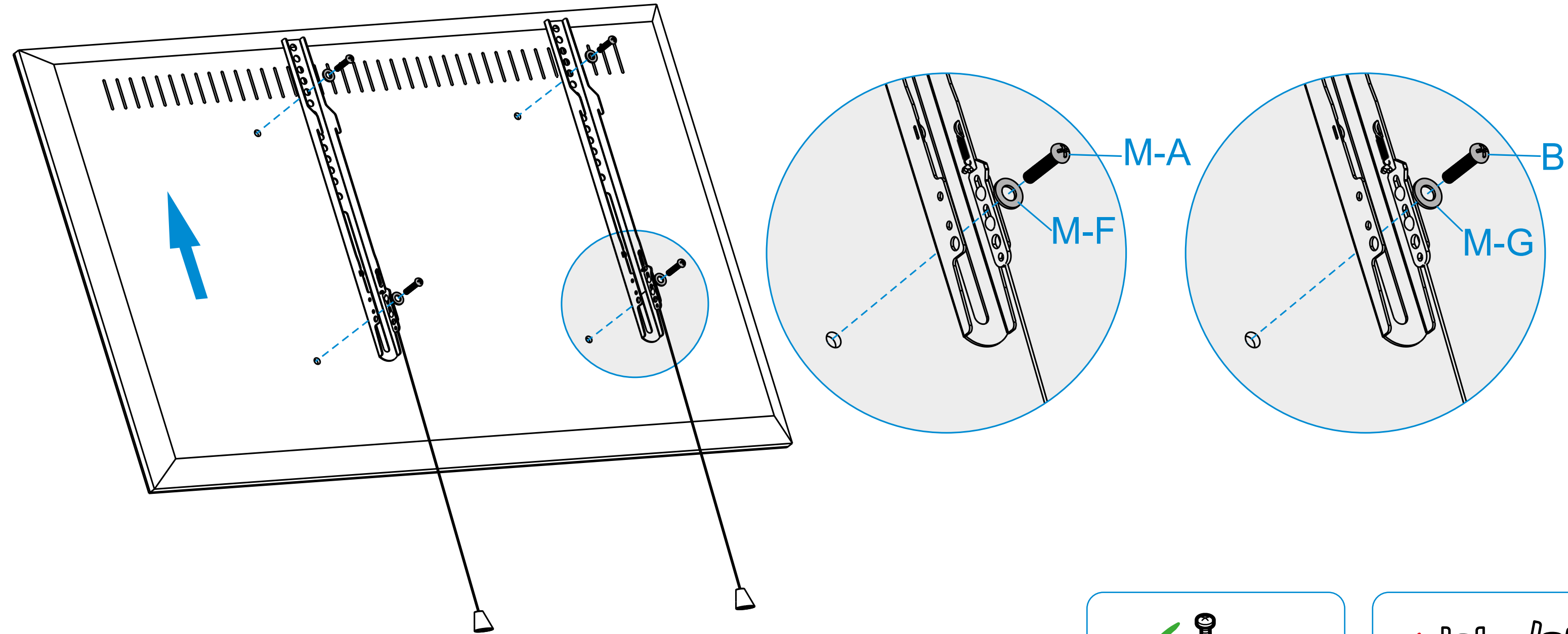



Instalación



3a

✓  

✗    

Instalación

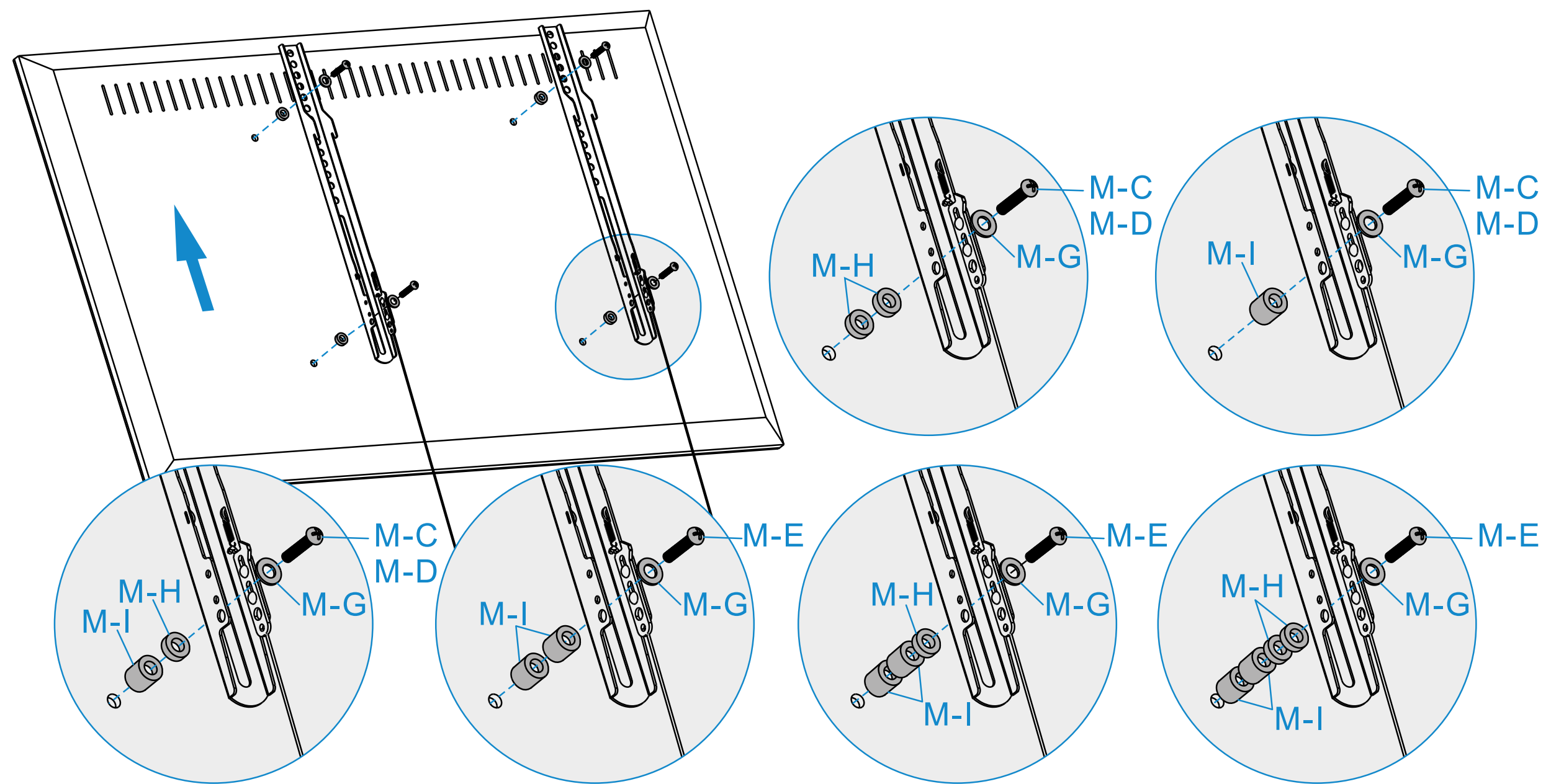

3b

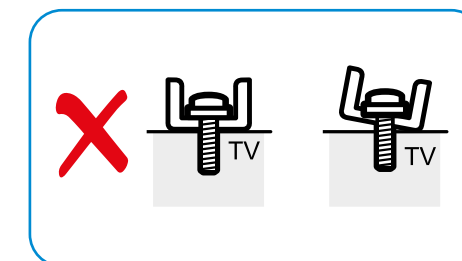
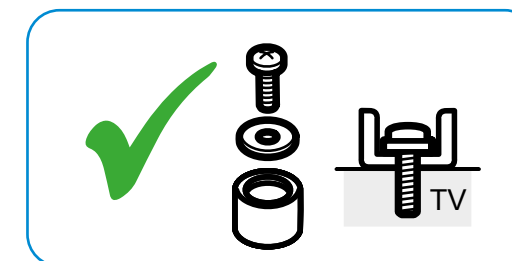

Instalación

4

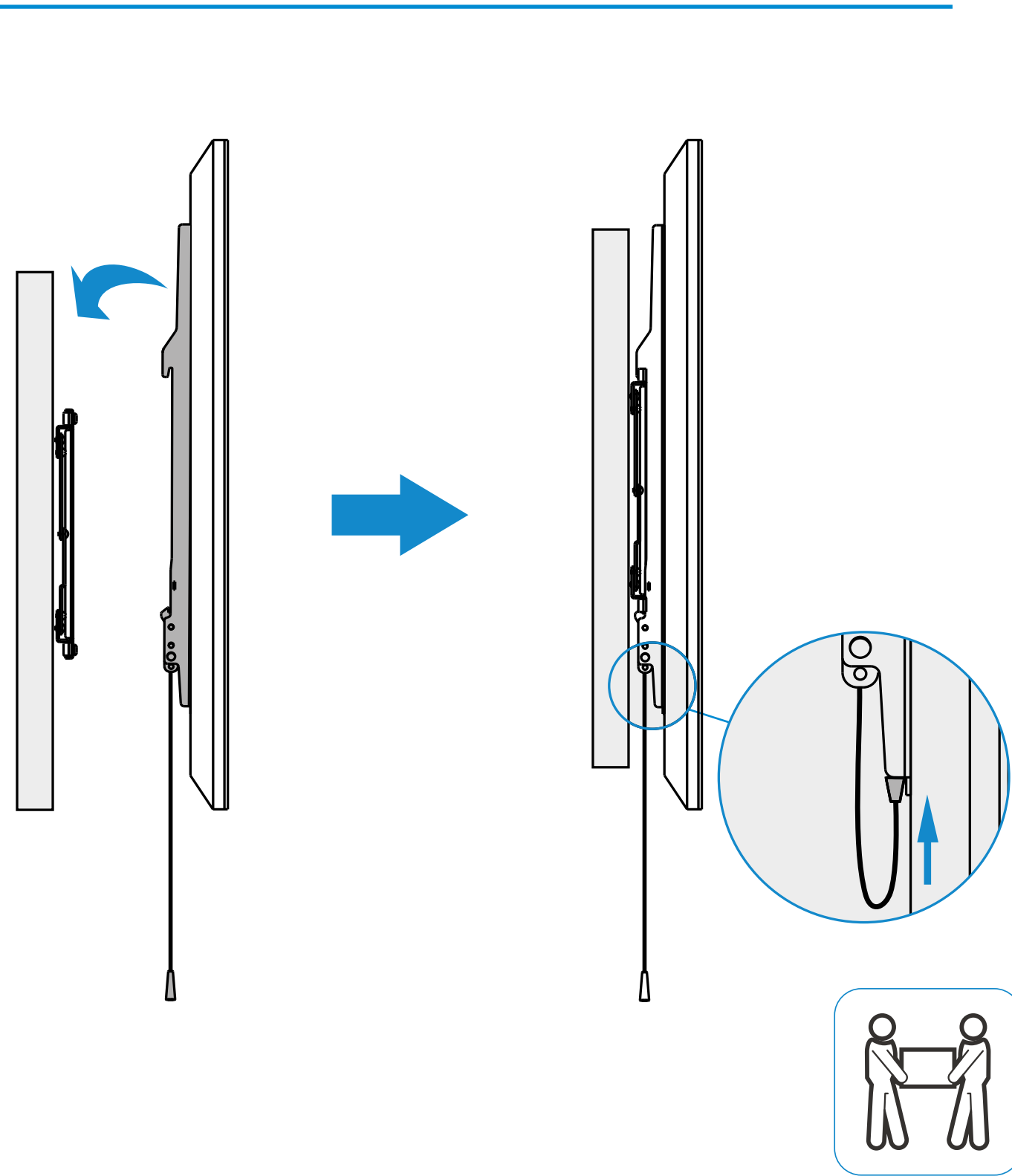

5

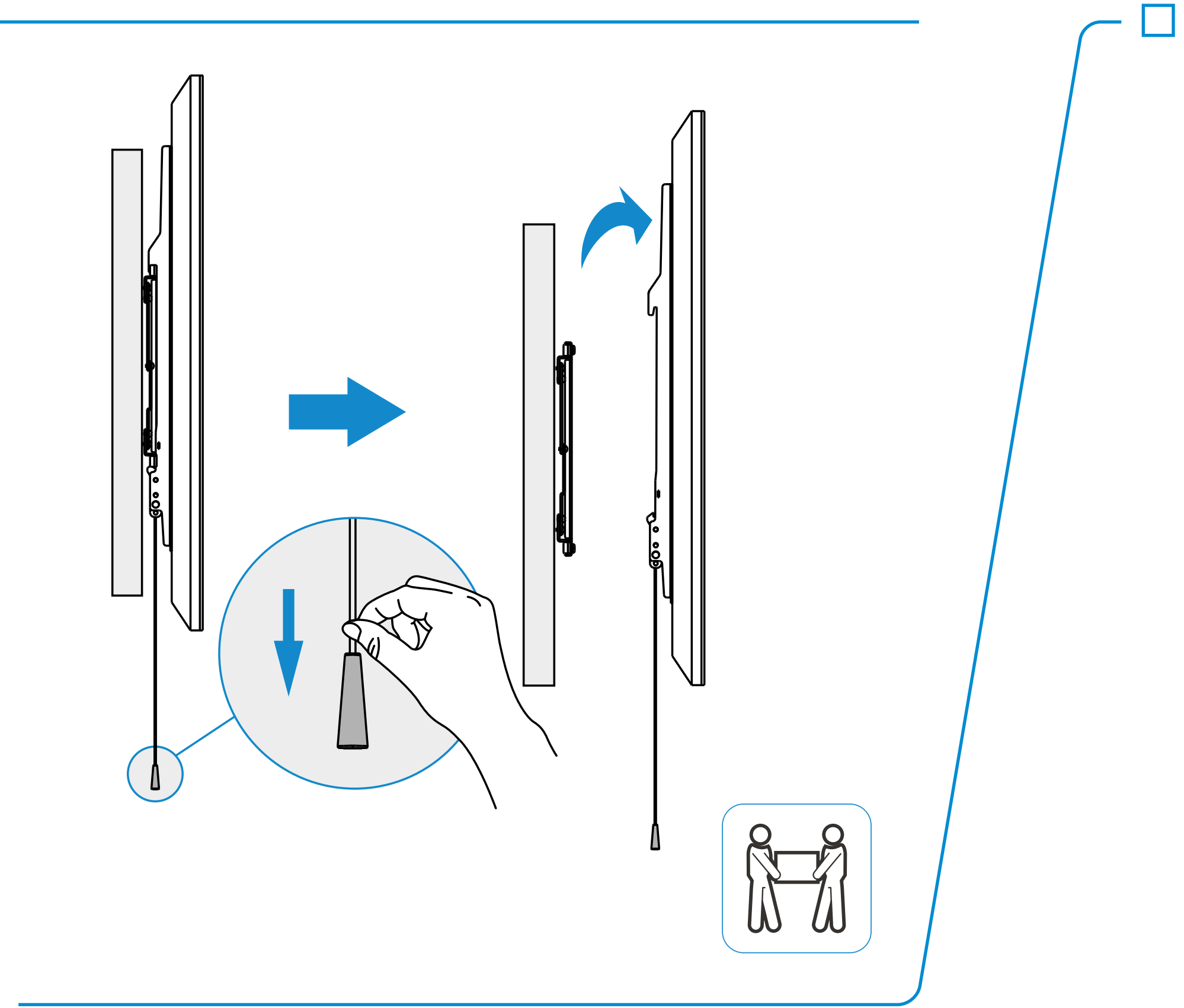

¡Entérate de todas nuestras novedades!

Síguenos en redes sociales

