

Yealink ZVC Series Zoom Rooms Kit



Yealink Network Technology CO., LTD

Yealink ZVC Series Zoom Rooms Kit Quick Start Guide

V30.50

English | 简体中文

Package Contents

• Yealink ZVC640 Zoom Rooms Package

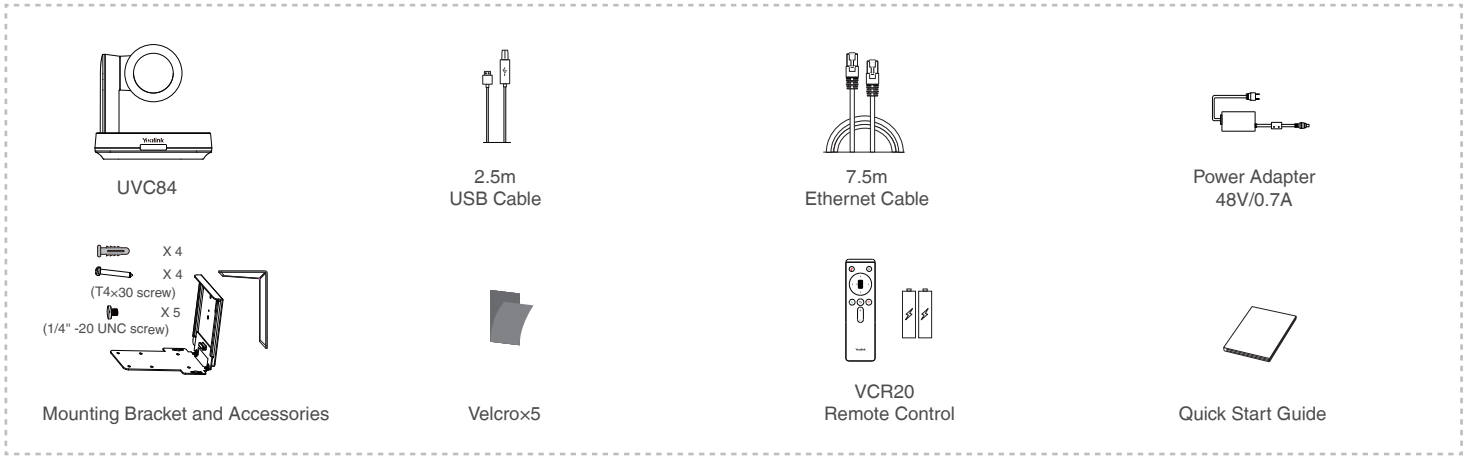

UVC84 Package (Camera)

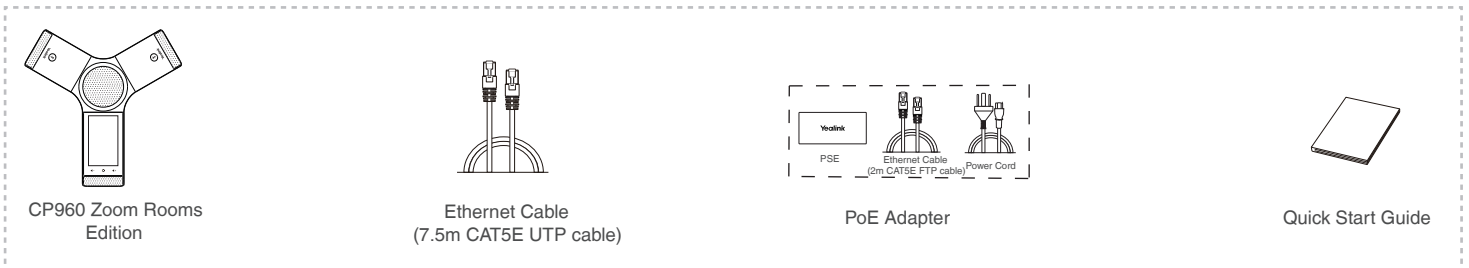

CP960 Package

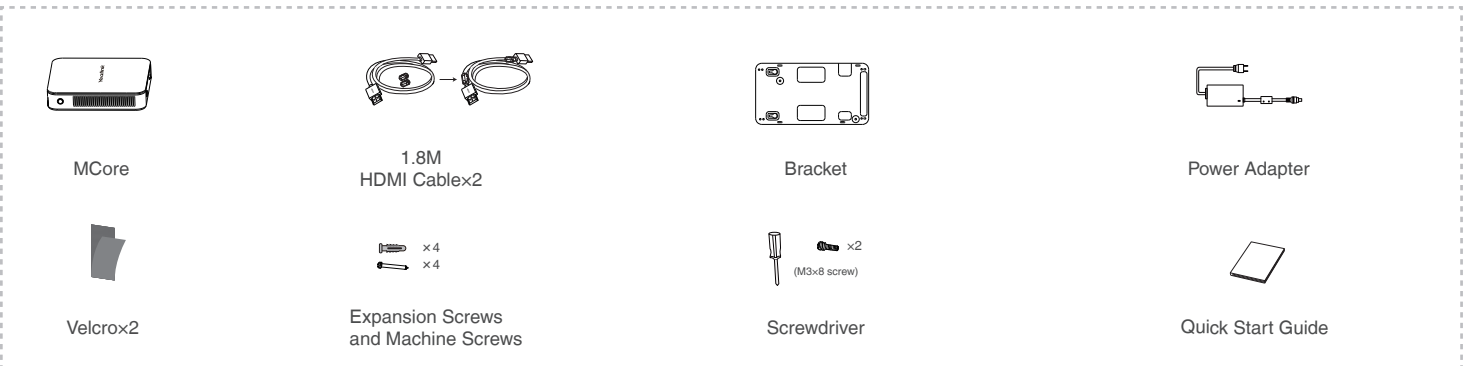

MCore Package (Mini-PC)

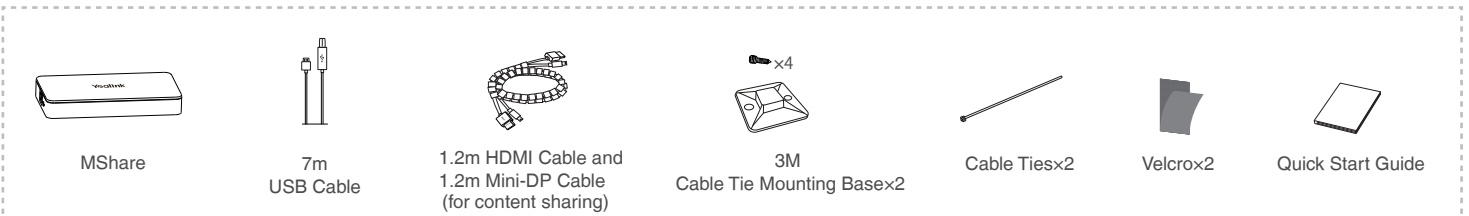

(Optional) MShare Package



Pen Holder

• Yealink ZVC300 Zoom Rooms Package



UVC30 Room Package

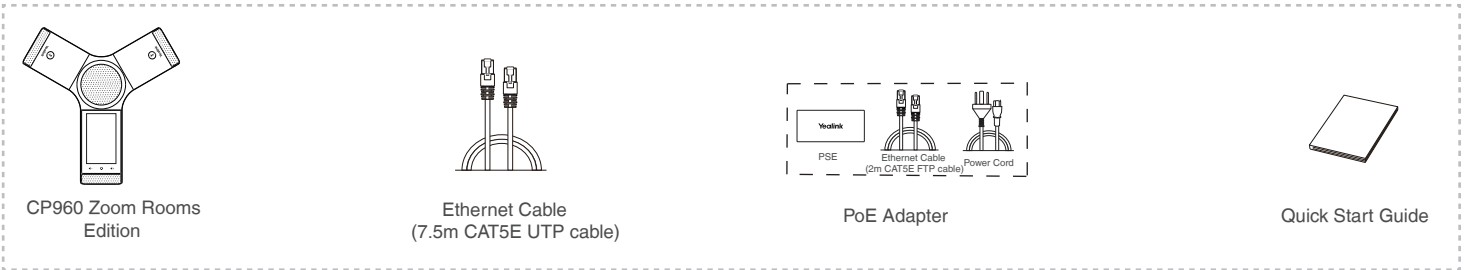

CP960 Package

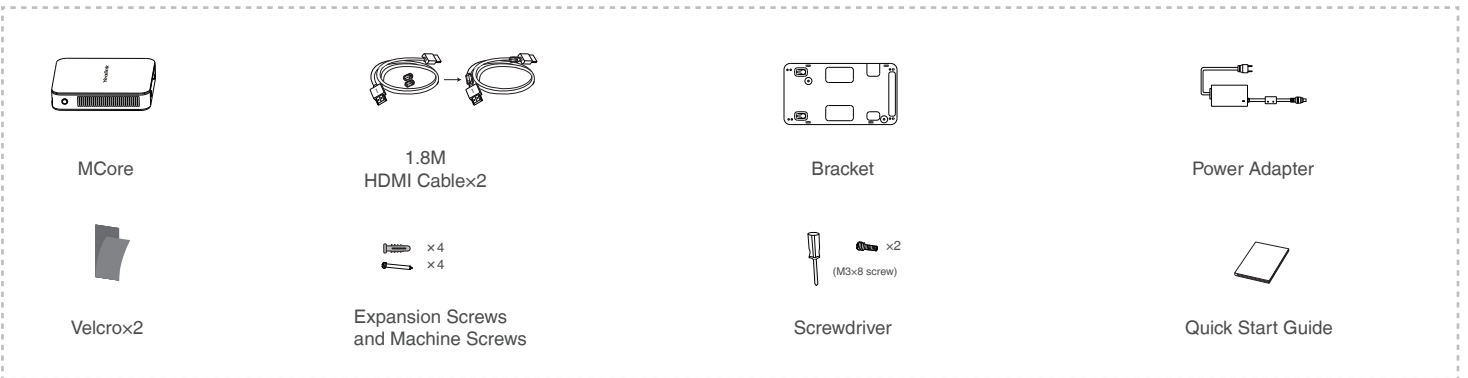

MCore Package (Mini-PC)

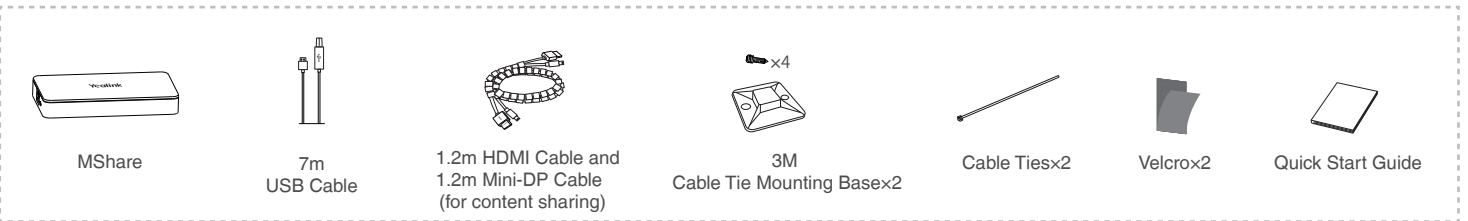

(Optional) MShare Package

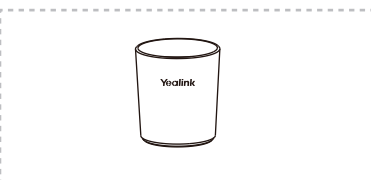

Pen Holder



We recommend that you use the accessories provided or approved by Yealink. The use of unapproved third-party accessories may result in poor performance.

Overview of Yealink Solution for Zoom Rooms

After connecting the CP960 running Zoom Rooms version to the same LAN as the MCore, you can take it as Zoom Rooms controller, speaker, and microphone.

Yealink Plugin for Zoom Rooms and Zoom Rooms app have been installed on the MCore.

And the UVC84/UVC30 camera is Plug-and-play.

Make sure your phone and MCore can access the Internet.

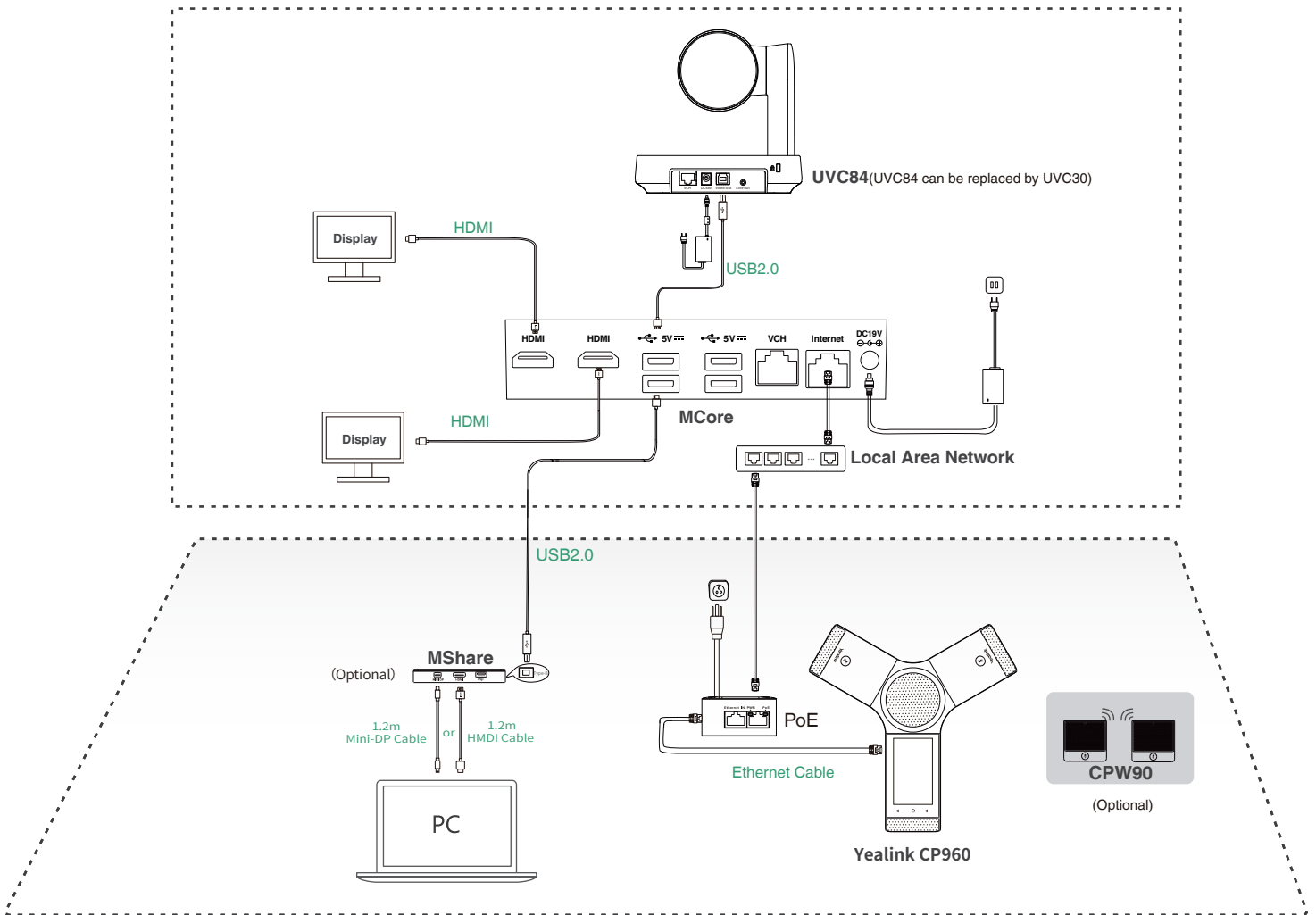

💡 The CP960 should be powered by PoE adapter (54V/0.56A) or PoE switch. All devices are powered separately. The cable should be replaced at once if its skin is broken.

Assembling the CP960

1a. Connect the power and wired network.

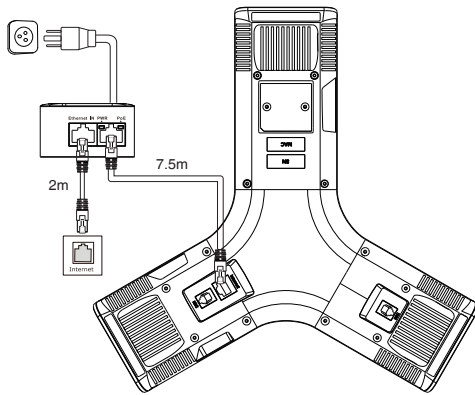

1b. Connect the power and wireless network.

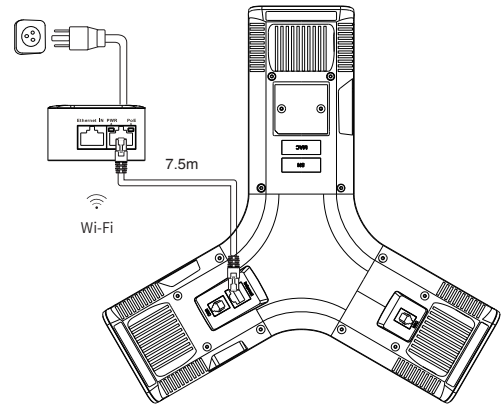

Refer to **Wireless Network Connection** mentioned below in **Configuring Your CP960** for more information.

2(Optional).Connect the wireless microphone.

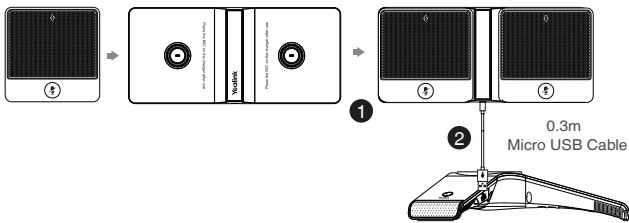

Step:

- 1 Put the CPW90 on the charging cradle.
- 2 Connect the micro USB port on the charging cradle to the USB port on the CP960 using a 0.3m USB cable. The CPW90 enters the registration mode automatically. And the mute LED indicator on the CPW90 fast flashes yellow.
- 3 Swipe down from the top of the CP960 touch screen and then tap **Settings->MIC->+**.
- 4 Long press the mute key on the CPW90 for 5 seconds. The CPW90 is registered with the CP960 conference phone automatically.

💡 For more information about the instructions of Mute LED indicator on the CPW90, refer to Yealink CPW90 Quick Start Guide.

Connecting the MCore

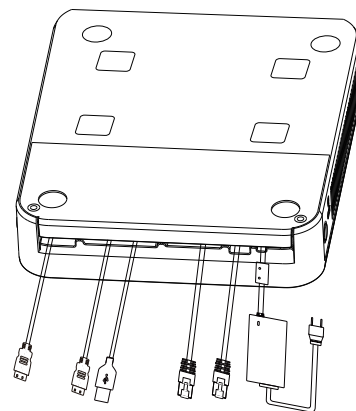
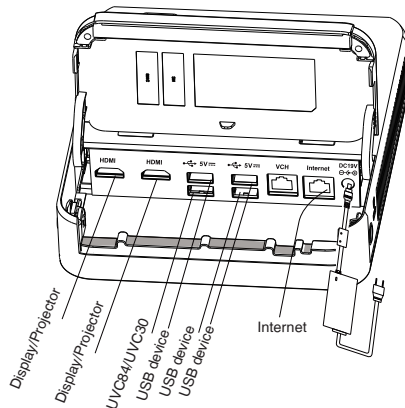

💡 For convenience, we recommend that you connect a wireless USB dongle to the back of the MCore to use mouse and keyboard to manage devices.

💡 For more information on how to assemble and install the MCore, refer to Yealink MCore Quick Start Guide (EN, CN).

Pairing the Zoom Rooms with CP960

Before using CP960 as the Zoom Rooms controller, you need to pair the CP960 (preload the Zoom Rooms Controller) with the MCore (preload the Zoom Rooms app).

Ensure that the plugin is in operation.

Procedure

1. After the MCore is powered on, the **Zoom Rooms** app will be started automatically.
The pairing code will be displayed on the screen. Otherwise, you need to open the **Zoom Rooms** app manually.
Starting the MCore for the first time may take a long time to configure the Windows system, and you need to connect the wireless keyboard and mouse to complete the initial configuration.
2. Enter the pairing code on the touch screen of the CP960.
Then the CP960 (Zoom Rooms Controller) is paired with the MCore (Zoom Rooms app) successfully.

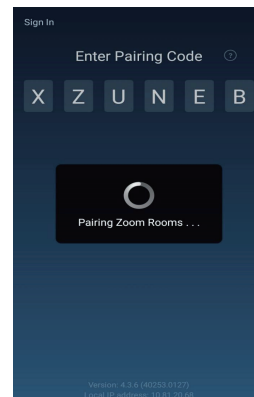

Using CP960 as an Audio Input and Output Device

After pairing your CP960 with the MCore, you can use it as a default audio input and output device for the system.

Procedure

1. Tap **⚙️** on the touch screen.
2. Disable **Lock Settings**.
You need to enter the room password to change the setting.

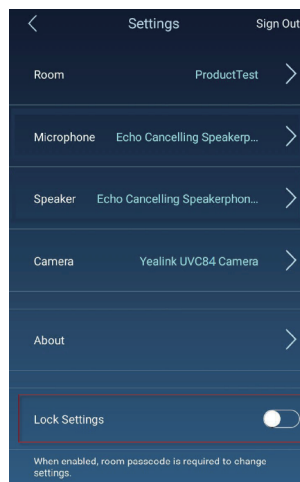

3. Tap the **Microphone** field and then select **Echo Cancelling Speakerphone (Yealink CP960 Speakerphone)** as your audio input device from the **SOURCE** field.

4. Tap the **Speaker** field and then select **Echo Cancelling Speakerphone (Yealink CP960 Speakerphone)** as your audio output device from the **SOURCE** field.

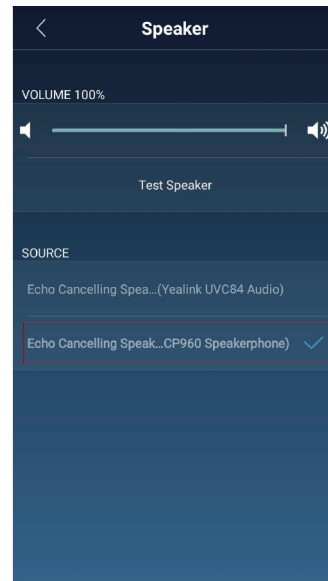
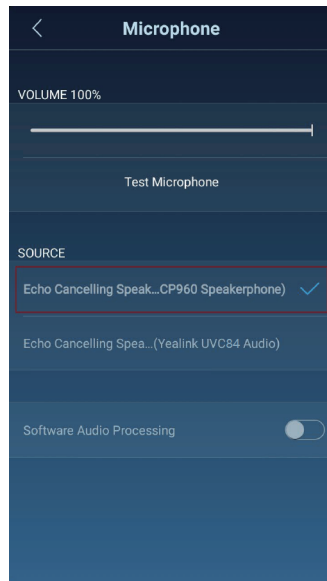

Generally, you can use the Yealink solution for Zoom Rooms after pairing your phone with the MCore and setting your phone as an audio input and output device.

For more information about your phone and Yealink Plugin for Zoom Rooms, read below.

Using CP960 as Zoom Rooms Controller

After pairing your CP960 with the MCore, you can use it as a Zoom Rooms controller.

Signing into your Zoom account on your phone

1. Tap **Sign In** on the touch screen.
2. Enter the email and password.
3. Tap **Sign In**.

The account is signed into the Zoom Room app synchronously.

Signing out of your Zoom account from your phone

1. Tap **⚙️** -> **Sign Out** on the touch screen.
2. Enter the password to sign out.
3. Tap **OK**.

Basic features on the home screen of the phone:

After you sign into an account on your phone, more features are available on the phone.

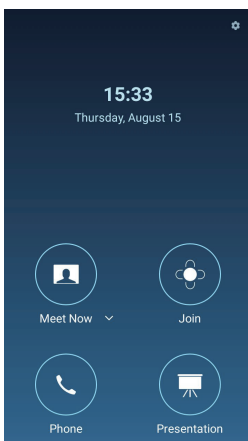

-Meet Now: Tap **Meet Now** to create an instant meeting.

-Join: Tap **Join** to join a meeting by entering the meeting ID or personal link name.

-Phone: Tap **Phone** to place a call.

-Presentation: Tap **Presentation** to start a presentation.

- ⚙️ : Tap **⚙️** to check the status of the connected microphone, speaker and camera, and configure basic settings.

You can also view the Controller version, Zoom Rooms version and Controller IP at the path of **⚙️** -> **About**.

-Camera Control: During a meeting, tap **Camera Control** to control the camera.

Configuring Your CP960

Configuring via web user interface

Accessing the web user interface:

1. Swipe down from the top of the screen to enter the device setting screen.
2. Tap **Status** to obtain the IP address of the phone.
3. Open a web browser on your computer, enter the IP address into the address bar (For example., "http://192.168.0.10" or "192.168.0.10").
4. Enter the user name (default: admin) and password (default: admin) in the login page and then click **Login**.

Network Settings: On the web user interface, click **Network->Basic**.

Customizing your phone: On the web user interface, click **Settings** to configure the time and date. Click **Settings->Preference** to set the backlight active level and time.

Configuring via phone user interface

Device Settings of the CP960:

Swipe down from the top of the screen to enter the device setting screen.

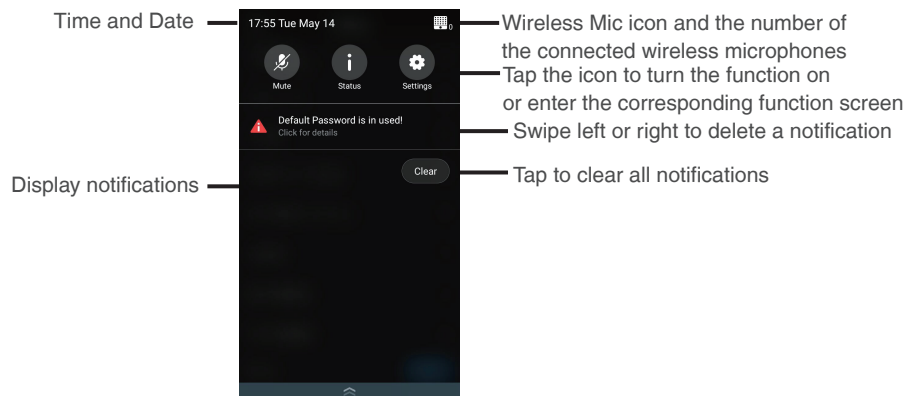

Network Settings: On the device setting screen, tap **Settings->Advanced Settings** (default password: admin)->**Network**.

Wireless Network Connection:

1. On the device setting screen, tap **Settings->Basic Settings->Wi-Fi**.
2. Turn **Wi-Fi** on.
The phone will automatically search for available wireless networks in your area.
3. Tap an available wireless network from the list of networks.
4. If the network is secure, enter its password in the **Password** field and then tap **Connect**.

Setting the signal port of Yealink Plugin: On the device setting screen, tap **Settings->Advanced Settings** (default password: admin)->**Yealink Plug-in Settings->Signal Port**.

Customizing your phone: On the device setting screen, tap **Settings->Basic Settings->Language & Input** to set the language and input for the phone. Tap **Settings->Basic Settings->Display** to set the backlight active level, backlight time, screensaver wait time and screensaver type.

Using Hybrid Mode

Yealink Solution for Zoom Rooms supports the hybrid mode that allows you to switch between SIP mode and Zoom Rooms mode to experience Zoom video conferences as well as SIP calls and conferences. In SIP mode, you can use basic call features, including placing/answering calls, initiating a conference, recording calls, and so on.

Enabling the Hybrid Mode

1. On the device setting screen, tap **Settings->Advanced Settings** (default password: admin).
2. Turn **Hybrid Mode** on.
It prompts that if you are sure to switch mode.
3. Tap **OK**.
This configuration will take effect after a reboot.

Switching Between SIP Mode and Zoom Rooms Mode

After the hybrid mode enabling, you can switch between SIP mode and Zoom Rooms mode quickly on the phone when you are not in a call.

1. Under the Zoom Rooms mode, tap the floating circle to switch to the SIP mode.
2. Under the SIP mode, tap the floating circle or tap the **Zoom Rooms** app icon to switch back to the Zoom Rooms mode.

Wireless Content Sharing

You can use Yealink WPP20 wireless presentation pod for wireless content sharing. You need to purchase WPP20 separately.

Make sure the MShare is connected to the MCore.

Procedure

1. Connect the WPP20 to the USB port of the MShare.
2. Wait for about 3 seconds, the WPP20 LED indicator glows green.

The WPP20 is paired with the MShare successfully.

3. Connect the WPP20 to the PC.



Devices Management

ZoomRooms account is the default account from which the Zoom Rooms app runs. Only the ZoomRoomsAdmin account has access to return to the desktop of the MCore to manage the devices. After switching the user account to ZoomRoomsAdmin, you can enable Windows Update service to update the devices.

And we also support updating the firmware for CP960 via web user interface or on the Yealink device management platform. For more information on how to update a batch of phones on the Yealink device management platform, please go to <http://support.yealink.com>, and then click **Download->Service->Device Management Platform/Management Cloud Service** to see the administrator guide.

Switching to the ZoomRoomsAdmin Account

1. Press **Ctrl+Alt+Delete** and then select **Sign out**.
2. Click the **ZoomRoomsAdmin** account from the bottom-left corner and then enter the password (default: zoom123) to return to the desktop of the MCore.

 The default password required to switch back to the ZoomRooms account is zoom123.

Enabling Windows Update Service

1. Open a command prompt Windows on your MCore.
2. Type **services.msc**, and press **Enter**.
3. Find **Windows Update** service, and double-click to open **Properties**.
4. Enable **Windows Update** service from the **Startup type** field.
5. Click **OK**.

Update the Devices

The devices can be upgrade manually or can be automatically upgraded if you enable automatically Windows Update.

Enabling Automatically Windows Update

1. Click the **Start** button, and then go to **Settings->Upgrade & Security->Windows Update**, and select **Advanced options**.
2. Enable **Automatically download updates, even over metered data connections (charge may apply)**.

Manually Windows Update

1. Do one of the following:
 - Press the **Windows key + X** or right-click the Start to open the **Power User Menu**. Click **Device Manager**. Right click the desired device and then select **Update driver**. Select a desired way to update.
 - Click the Start button, and then go to **Settings->Upgrade & Security->Windows Update**, and select **Check for updates**. Select the plugin or UVC84/UVC30 camera and then complete the installation.

包装清单

• 亿联 ZVC640 Zoom Rooms 产品包

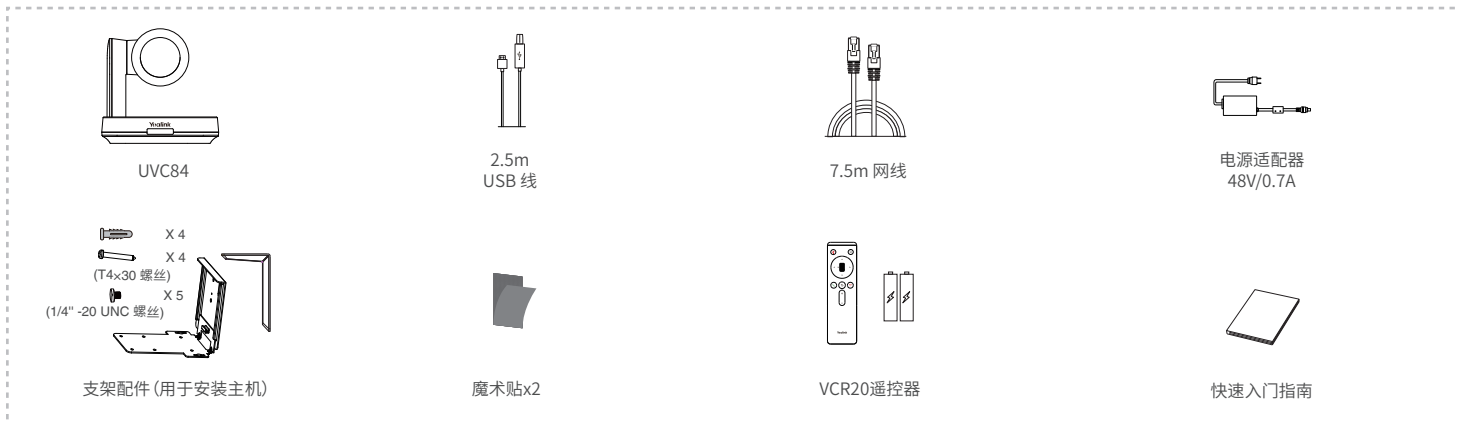

UVC84套件(摄像机)

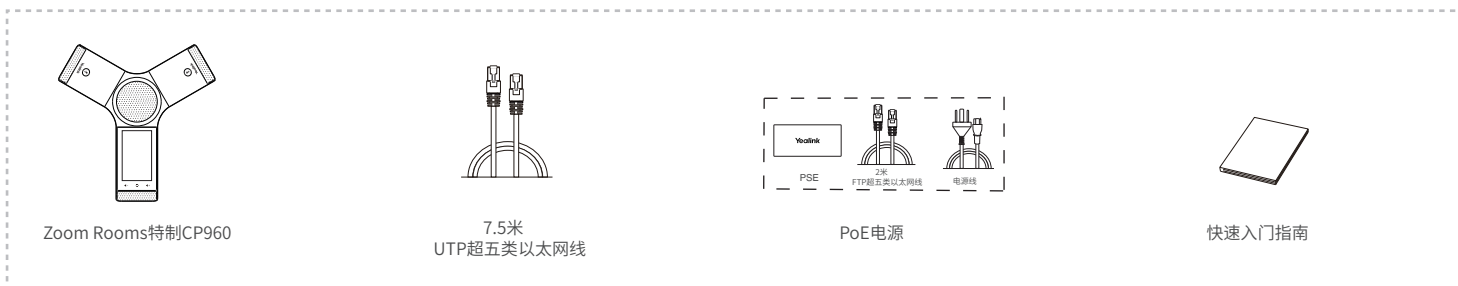

CP960套件

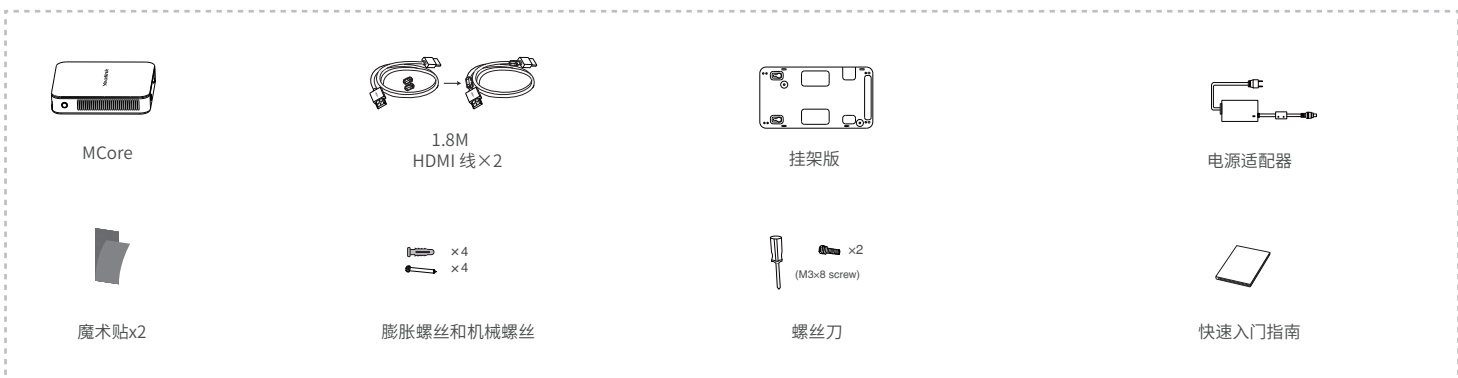

MCore套件 (Mini-PC)



(可选) MShare套件



• 亿联 ZVC300 Zoom Rooms 产品包

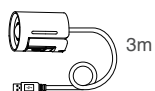

UVC30 Room



镜头盖

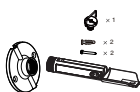

支架和配件



螺丝刀



快速入门指南

UVC30 Room套件(摄像机)

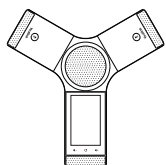

Zoom Rooms特制CP960

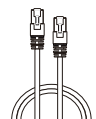

7.5米
UTP超五类以太网线

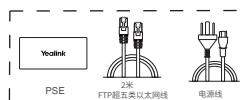

PoE电源



快速入门指南

CP960套件



MCore

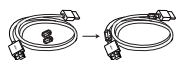

1.8M
HDMI 线×2



挂架版

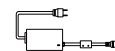

电源适配器



魔术贴x2



膨胀螺丝和机械螺丝



螺丝刀



快速入门指南

MCore套件 (Mini-PC)



MShare



7米USB线



1.2米 HDMI线和
1.2米 Mini-DP线
(用于内容分享)



3M背胶固定座×2



扎带×2



魔术贴×2



快速入门指南

(可选) MShare套件



收纳桶



我们推荐使用由Yealink提供或经Yealink认可的配件和线缆, 使用未经认可的第三方配件和线缆可能会导致性能的下降。

Zoom Rooms解决方案

Zoom Rooms版本CP960与接入同一局域网的PC进行通信连接,并可作为Zoom Rooms控制器,扬声器和麦克风。

Yealink插件和Zoom Rooms app预装在MCore上。UVC84/UVC30摄像机即插即用。

确保CP960和MCore可访问外网。

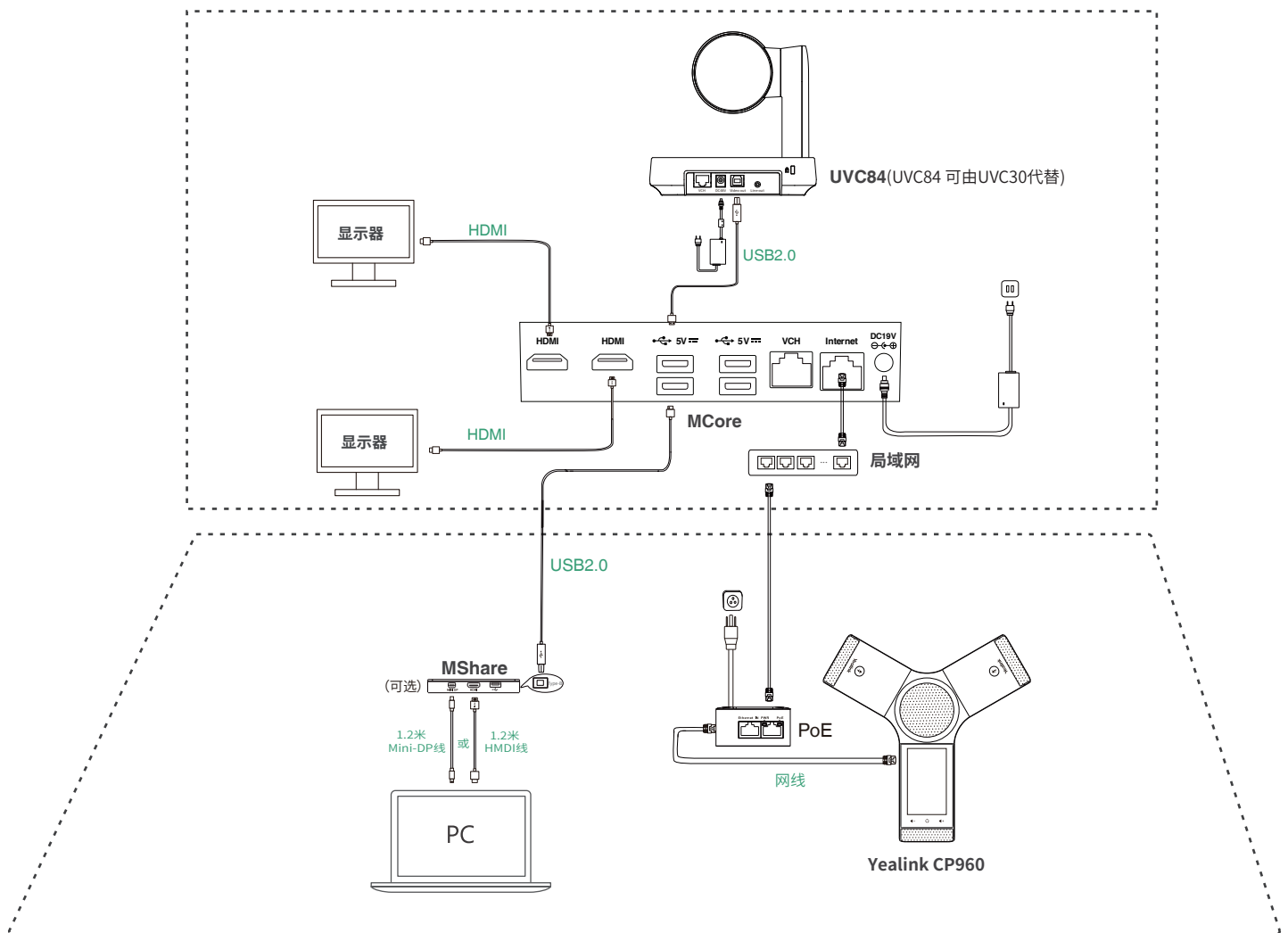

💡 我们要求使用Yealink原装PoE电源(54V/0.56A),所有设备单独供电。
如果电源线或网线破皮,请立即更换。

安装CP960话机

1a. 连接电源和有线网线。

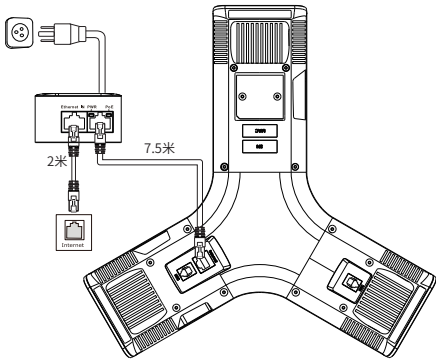

1b. 连接电源和无线网线：

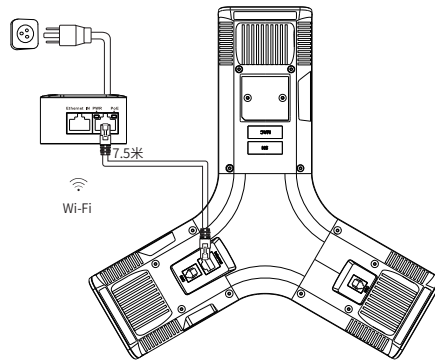

想要了解更多信息, 请参考配置话机章节中的无线网络连接。

2(可选).连接有线扩展麦CPE90。

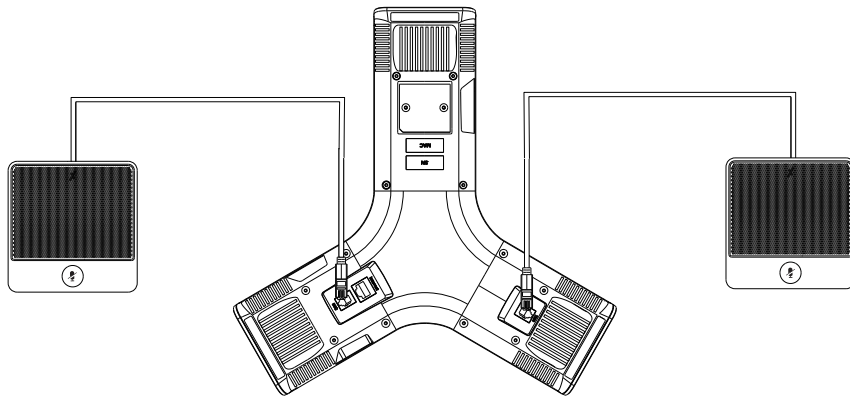

连接MCore

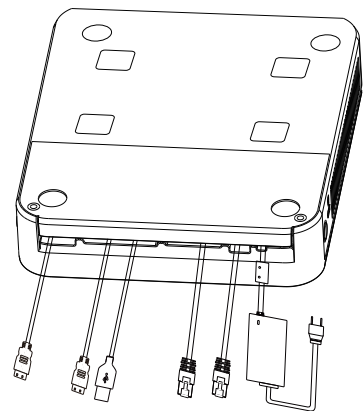
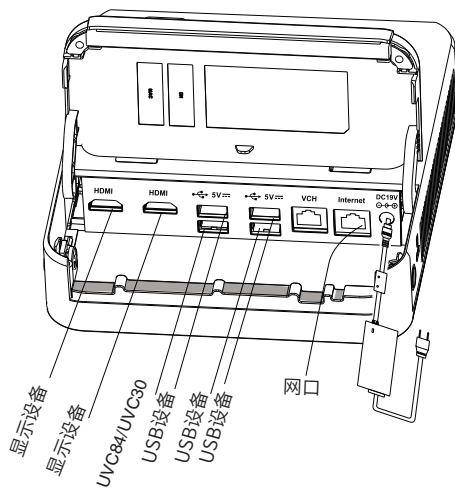

💡 我们推荐你将无线USB dongle连接到MCore, 以便使用无线鼠标和键盘操作。

💡 更多关于如何安装MCore, 请参阅 Yealink MCore Box Quick Start Guide(EN, CN)。

CP960与Zoom Rooms配对

CP960作为Zoom Rooms控制器前,你需要将CP960(预装Zoom Rooms Controller)和 MCore(预装Zoom Rooms app)配对。

确保Yealink插件在运行。

过程

1. 启动MCore后, Zoom Rooms app会自动启动。

配对码显示在显示器上。若Zoom Rooms app未自动运行,你需要手动开启 Zoom Rooms。

主机第一次启动可能会花费较长时间进行Windows系统配置,你需要连接无线键鼠完成初始配置。

2. 在CP960上输入配对码。

CP960 (Zoom Rooms Controller) 与MCore (Zoom Rooms app)配对成功。

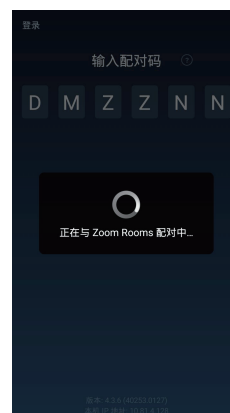

将CP960作为音频输入和输出设备

CP960与MCore配对后,CP960将作为系统默认的音频输入和输出设备。

过程

1. 在CP960上,按 .

2. 关闭**锁定设置**。

你需要输入会议室密码才能更改该配置。

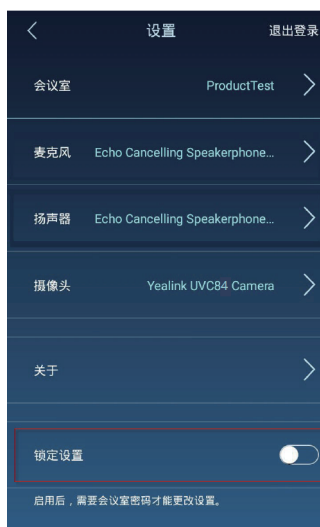

3. 选择**麦克风**,在设备列表区域选择**Echo Cancelling Speakerphone (Yealink CP960 Speakerphone)**作为音频输入设备。

4. 选择**扬声器**, 在设备列表区域选择**Echo Cancelling Speakerphone (Yealink CP960 Speakerphone)** 作为音频输出设备。

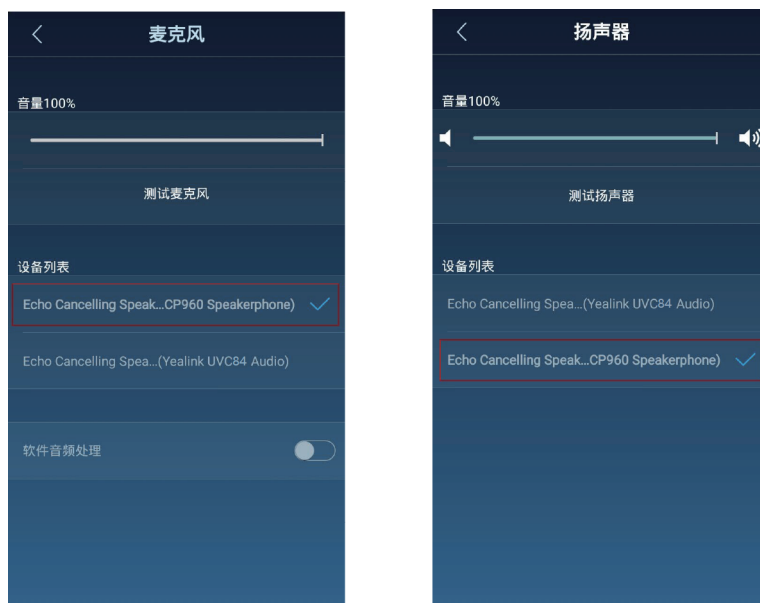

正常情况下, CP960与MCore配对, 并将CP960设置为音频输入和输出设备后, 你可以开始使用Zoom Rooms解决方案。

有关CP960和Yealink插件的更多信息, 请阅读以下内容。

将CP960作为Zoom Rooms控制器使用

CP960与MCore配对后, 可作为Zoom Rooms控制器使用。

在CP960上登录Zoom Rooms账号

1. 按**登录**。
2. 输入**电子邮件地址**和**密码**。
3. 按**登录**。

账号同时自动登录Zoom Room app。

在CP960上登出Zoom Rooms账号

1. 按 -> **退出登录**。
2. 输入会议室密码退出登录。
3. 按**确定**。

CP960上可操作的基本功能:

在CP960上登录帐户后, 你可以使用以下基本功能:



- 开始会议**: 按**开始会议**创建一个即时会议。
- 加入**: 按**加入**, 通过输入会议ID或个人标签加入会议。
- 电话**: 按**电话**呼出一路通话。
- 演示**: 按**演示**开始共享屏幕。
- : 按 检查已连接麦克风, 扬声器和摄像头的状态并基本设置。
在 -> **关于**路径下, 你还可以查看控制器版本, Zoom Rooms版本和控制器IP。
- 控制摄像机**: 会议中, 按**控制摄像机**可调整摄像机焦距和角度。

配置CP960

通过Web界面配置CP960

访问Web界面：

1. 从屏幕顶部向下滑动，进入设备设置中心。
2. 按**状态**查看话机的IP地址。
3. 打开电脑上的网页浏览器，在地址栏里输入话机的IP地址（例如：http://192.168.0.10或192.168.0.10），按**Enter**键。
4. 在登录界面的输入用户名（默认密码:admin）和密码（默认密码:admin），点击**登录**。

网络配置：在网页界面点击**网络配置->基础**，你可以为话机配置网络。

自定义话机：在网页界面点击**设置**，你可以设置日期和时间；点击**设置->优先**设置背光灯激活亮度等级和背光灯时间。

通过话机界面配置CP960

CP960话机设备设置中心

从屏幕顶部向下滑动，进入设备设置中心。

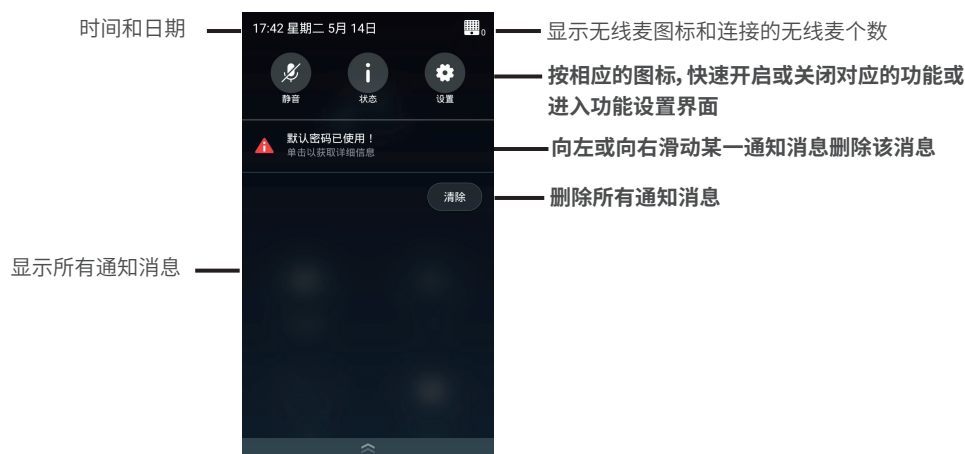

网络配置：在话机设备设置中心界面，点击**设置->高级设置**（默认密码:admin）->**网络**为话机配置网络。

无线网络连接：

1. 在话机设备设置中心界面，按**设置->基础设置->无线网络**。
2. 开启**无线网络**。
话机将自动搜索附近可用的Wi-Fi。
3. 从可用的网络列表中，选择一个Wi-Fi。
4. 如果要连接一个加密的网络，在**密码**区域中输入密码，再按**连接**。

设置Yealink插件信令端口：在话机设备设置中心界面，按**设置->高级设置**（默认密码:admin）->**Yealink插件设置->信令端口**。

自定义CP960：在话机设备设置中心界面，按**设置->基础设置->语言和输入法**设置CP960话机显示语言和输入法，按**设置->基础设置->显示**设置背光灯亮度与激活时间和屏保激活时间与屏保类型。

使用混合模式

亿联Zoom Rooms解决方案支持混合模式,使你可以在SIP模式和Zoom Rooms模式之间任意切换,让你既可以体验Zoom视频会议也可以使用SIP通话和会议。

SIP模式下,你可以使用基本通话功能,包括拨打、接听电话、发起会议和录制呼叫等。

开启混合模式

过程

1. 在话机设备设置中心界面,按**设置**->**高级设置**(默认密码:admin)。

2. 开启**混合模式**。

界面提示模式切换会设备重新启动,是否确认继续。

3. 按**确定**。

话机重启后,配置生效。

切换SIP模式与Zoom Rooms 模式

启用混合模式后,你可以在非通话状态下快速切换SIP模式和Zoom Rooms模式。

过程

1. 在Zoom Rooms模式下,按悬浮球切换至SIP模式。

2. 在SIP模式下,按悬浮球或桌面的**Zoom Rooms** app图标切换至Zoom Rooms模式。

无线投屏

你可以使用WPP20无线传屏助手进行无线投屏。WPP20需要单独购买。

分享内容前,确保MShare已正确连接在MCore上。

过程

1. 将WPP20连接到MShare的USB口。

2. 约3秒后,WPP20指示灯显示绿色常亮。

WPP20与MShare配对成功。

3. 将WPP20连接到电脑上。



设备管理

Zoom Rooms会议系统默认使用ZoomRoom帐户,只有ZoomRoomsAdmin帐户才有权限返回桌面操作MCore。切换到管理员帐户并开启Windows Update服务后,你可以手动升级设备,或开启自动Windows Update更新升级设备。

我们还支持在亿联设备管理平台上升级CP960。更多关于如何在设备管理平台上批量升级更新设备,请前往<http://support.yealink.com>,选择**文档&软件->服务平台->设备管理平台/设备管理云服务**查看对应平台的管理员指南。

切换到ZoomRoomsAdmin帐户

1. 按**Ctrl+Alt+Delete**,选择**注销**。
2. 在界面左下角选择**ZoomRoomsAdmin**帐户,输入密码(默认:zoom123)返回桌面。

 重新切换回ZoomRooms帐户的密码默认也为zoom123。

开启Windows Update服务

1. 在MCore桌面打开命令窗口。
2. 输入**services.msc**,按**Enter**键。
3. 找到**Windows Update**服务,双击打开**属性**。
4. 在**启动类型**区域,开启**Windows Update**服务。
5. 点击**确定**。

更新设备

你可以通过Windows Update手动更新设备,也可以开启自动Windows更新功能自动升级设备。

手动更新升级设备

1. 执行以下任一操作:
 - 按**Windows+X**或者右击开始菜单打开**用户高级菜单**,选择**设备管理器**。选择并右击需要更新的设备,并选择**更新驱动程序**。选择需要更新的方式。
 - 点击开始菜单,选择**设置->更新和安全->Windows更新**,选择**检查更新**。选择插件或UVC84/UVC30摄像机,并完成安装。

开启Windows自动更新

1. 点击开始菜单,选择**设置->更新和安全->Windows更新**,再按**高级选项**。
2. 开启**自动下载更新**,即使通过按流量计费的数据连续也是如此(可能会收费)。

Regulatory Notices

Operating Ambient Temperatures

- Operating temperature: +32 to 104°F (0 to 40°C)
- Relative humidity: 5% to 90%, noncondensing
- Storage temperature: -22 to +160°F (-30 to +70°C)

Warranty

Our product warranty is limited only to the unit itself, when used normally in accordance with the operating instructions and the system environment. We are not liable for damage or loss resulting from the use of this product, or for any claim from a third party. We are not liable for problems with Yealink device arising from the use of this product; we are not liable for financial damages, lost profits, claims from third parties, etc., arising from the use of this product.

Explanation of the symbols

- DC symbol

⎓ is the DC voltage symbol.

- WEEE Warning symbol

 To avoid the potential effects on the environment and human health as a result of the presence of hazardous substances in electrical and electronic equipment, end users of electrical and electronic equipment should understand the meaning of the crossed-out wheeled bin symbol. Do not dispose of WEEE as unsorted municipal waste and have to collect such WEEE separately.

Restriction of Hazardous Substances Directive (RoHS)

This device complies with the requirements of the EU RoHS Directive. Statements of compliance can be obtained by contacting support@yealink.com.

Safety Instructions

Save these instructions. Read these safety instructions before use!

General Requirements

- Before you install and use the device, read the safety instructions carefully and observe the situation during operation.
- During the process of storage, transportation, and operation, please always keep the device dry and clean, avoid collision and crash.
- Please attempt not to dismantle the device by yourself. In case of any discrepancy, please contact the appointed maintenance center for repair.
- Please refer to the relevant laws and statutes while using the device. Legal rights of others should be respected as well.

Environmental Requirements

- Place the device at a well-ventilated place. Do not expose the device under direct sunlight.
- Keep the device dry and free of dusts.
- Do not place the device on or near any inflammable or fire-vulnerable object, such as rubber-made materials.
- Keep the device away from any heat source or bare fire, such as a candle or an electric heater.

Operating Requirements

- Do not let a child operate the device without guidance.
- Do not let a child play with the device or any accessory in case of accidental swallowing.
- Please use the accessories provided or authorized by the manufacturer only.
- The power supply of the device shall meet the requirements of the input voltage of the device. Please use the provided surge protection power socket only.
- Before plugging or unplugging any cable, make sure that your hands are completely dry.
- Do not spill liquid of any kind on the product or use the equipment near water, for example, near a bathtub, washbowl, kitchen sink, wet basement or near a swimming pool.
- During a thunderstorm, stop using the device and disconnect it from the power supply. Unplug the power plug and the Asymmetric Digital Subscriber Line (ADSL) twisted pair (the radio frequency cable) to avoid lightning strike.

About Yealink

Yealink (Stock Code: 300628) is a global brand that specializes in video conferencing, voice communications and collaboration solutions with best-in-class quality, innovative technology and user-friendly experience. As one of the best providers in more than 140 countries and regions, Yealink ranks No.1 in the global market share of SIP phone shipments (Global IP Desktop Phone Growth Excellence Leadership Award Report, Frost & Sullivan, 2019).

Technical Support

Visit Yealink WIKI (<http://support.yealink.com/>) for the latest firmware, guides, FAQ, Product documents, and more. For better service, we sincerely recommend you to use Yealink Ticketing system (<https://ticket.yealink.com>) to submit all your technical issues.

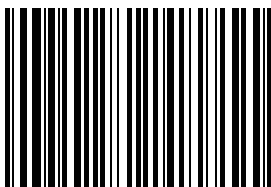

430104001537

- If the device is left unused for a rather long time, disconnect it from the power supply and unplug the power plug.
- When there is smoke emitted from the device, or some abnormal noise or smell, disconnect the device from the power supply, and unplug the power plug immediately.
- Contact the specified maintenance center for repair.
- Do not insert any object into equipment slots that is not part of the product or auxiliary product.
- Before connecting a cable, connect the grounding cable of the device first. Do not disconnect the grounding cable until you disconnect all other cables.

Cleaning Requirements

- Before cleaning the device, disconnect it from the power supply.
- Use a piece of soft, dry and anti-static cloth to clean the device.
- Keep the power plug clean and dry.

Troubleshooting

The unit cannot supply power to Yealink device.

There is a bad connection with the plug.

1. Clean the plug with a dry cloth.
2. Connect it to another wall outlet.

The usage environment is out of operating temperature range.

1. Use in the operating temperature range.

The cable between the unit and the Yealink device is connected incorrectly.

1. Connect the cable correctly.

You cannot connect the cable properly.

1. You may have connected a wrong Yealink device.

2. Use the correct power supply.

Some dust, etc., may be in the port.

1. Clean the port.

Contact your dealer or authorized service facility for any further questions.

FCC Statement

This device complies with part 15 of the FCC Rules. Operation is subject to the following

two conditions: (1) this device may not cause harmful interference, and (2) this device must accept any interference received, including interference that may cause undesired operation.

Any Changes or modifications not expressly approved by the party responsible for compliance could void the user's authority to operate the equipment.

IC Statement

This device complies with Industry Canada's licence-exempt RSSs. Operation is subject to the following two conditions:

(1) this device may not cause interference; and

(2) this device must accept any interference, including interference that may cause undesired operation of the device. CAN ICES-3(B)

Le présent appareil est conforme aux CNR d'Industrie Canada applicables aux appareils radio exempts de licence. L'exploitation est autorisée aux deux conditions suivantes :

(1) l'appareil ne doit pas produire de brouillage;

(2) l'utilisateur de l'appareil doit accepter tout brouillage radioélectrique subi, même si le brouillage est susceptible d'en compromettre le fonctionnement. NMB-3(B)

Radiation Exposure Statement(Only applicable to CP960)

This equipment complies with FCC and IC radiation exposure limits set forth for an uncontrolled environment. This equipment should be installed and operated with minimum distance 20cm between the radiator and your body.

Cet émetteur ne doit pas être Co-placé ou ne fonctionnant en même temps qu'aucune autre antenne ou émetteur. Cet équipement devrait être installé et actionné avec une distance minimum de 20 centimètres entre le radiateur et votre corps.

Contact Information

YEALINK NETWORK TECHNOLOGY CO.,LTD.

309, 3rd Floor, No.16, Yun Ding North Road, Huli District, Xiamen City, Fujian, P.R. C

YEALINK (EUROPE) NETWORK TECHNOLOGY B.V.

Strawinskylaan 3127, Atrium Building, 8th floor, 1077ZX Amsterdam, The Netherlands

YEALINK (USA) NETWORK TECHNOLOGY CO., LTD.

999 Peachtree Street Suite 2300, Fulton, Atlanta, GA, 30309, USA

Made in China

