



## 12G-SDI/NDI Bi-Directional Converter

# USER MANUAL

## Legal Notices

*Subject to the receiving of this document from Changsha Kiloview Electronics Co., Ltd.,(Hereinafter referred to “Kiloview”), the following terms are understood and agreed. Or else, please stop using this document.*

*This document is copyright of Kiloview, all rights reserved. The document covers the proprietary information of the company. No company or individual may copy, transmit, distribute, use or disclose the document and any images, forms, data and other information contained in the document without the prior written permission of the company.*

 *is the registered trademark of Kiloview. The name and logo are the trademarks or registered trademarks of the company. Other products or company names mentioned in this document may be the trademarks or registered trademarks of their respective owners. The reading of this document without the prior written consent of the company or the third party rights holder does not imply that the reader is given any right to use any of the marks appearing in this document by implication, non-evidence or otherwise.*

*This product complies with the design requirements related to environmental protection and personal safety. The storage, usage and disposal of the product shall be in accordance with the product manual, relevant contract or relevant national laws and regulations.*

*This document is provided "as is" and "only in this state". Products and technical updates are subject to change without prior notice.*

*For matters not covered in this document, please visit our website [www.kiloview.com](http://www.kiloview.com) for information and technical support.*

**NDI<sup>®</sup> is a registered trademark of NewTek, Inc.**

# COTENTS

<b>1 PRODUCT INTRODUCTION.....</b>	<b>3</b>
1.1 PRODUCT FEATURES.....	3
1.2 TECHNICAL PARAMETERS.....	4
<b>2 USER GUIDE.....</b>	<b>5</b>
<b>3 PACKING LIST AND INTERFACE DESCRIPTION.....</b>	<b>6</b>
3.1 PACKING LIST.....	6
3.2 INTERFACE.....	6
3.3 LED INDICATORS.....	8
<b>4 INSTALLATION AND CONNECTION.....</b>	<b>8</b>
4.1 CONNECT VIDEO SIGNAL.....	8
4.2 CONNECT NETWORK.....	9
4.3 CONNECT AUDIO.....	9
4.4 CONNECT POWER SUPPLY.....	10
<b>5 LOGIN AND NETWORK CONFIGURATION.....</b>	<b>11</b>
5.1 LOGIN TO THE DEVICE VIA ETHERNET.....	11
5.2 NETWORK CONFIGURATION.....	12
5.3 LOCAL-LINK (FAILSAFE).....	14
<b>6 NDI DISCOVERY AND MONITOR.....</b>	<b>15</b>
6.1 NDI TOOLS INSTALLATION.....	15
6.2 NDI DISCOVERY AND CONNECTION.....	16
6.3 NDI ENCODE BITRATE.....	17
<b>7 ENCODING PARAMETER CONFIGURATION.....</b>	<b>18</b>
7.1 STATUS COLUMN.....	18
7.2 BASIC SETTINGS.....	18
7.3 ADVANCED SETTINGS.....	19
7.3.1 NDI Connection.....	19
7.3.2 PTZ control.....	19
<b>8 NDI DECODING CONFIGURATION.....</b>	<b>21</b>
8.1 DISCOVER NDI SOURCE.....	22
8.2 OUTPUT OF NDI DECODING.....	23
8.3 DECODING PARAMETERS SETTING.....	25
8.4 DISCOVERY SERVICE.....	26
<b>9 SYSTEM SETTINGS.....</b>	<b>28</b>
9.1 USER MANAGEMENT.....	28
9.2 QUICK RESET.....	28
9.3 REBOOT.....	28
9.4 RESTORE FACTORY SETTINGS.....	28



## 1 Product Introduction

NDI® is the world's leading standard for video-over-IP technology. Kiloview N30 for NDI® converts 12G-SDI video and NDI® in both directions with the advantages of NDI®. This converter is small and compact enough to put in your pocket. N30 for NDI® supports up to 12G SDI (4K p60) video input (Encoder) or video output (Decoder). A tally system with a big tally light is built-in for indicating which camera is in program or preview. N30 supports wide DC input range from 5V to 18V which can be easily powered by USB, power bank or camera battery, or PoE. A threaded screw camera mount is equipped for camera mounting. PTZ control over USB adapter/Ethernet is supported. It also has the 3.5mm audio input/output which supports intercom (Note: Voice intercom not realized in this version).



### 1.1 Product Features

- **Bi-Directional converting, encoder and decoder, all-in-one**
- Plug and play, converting 12G SDI to NDI, or NDI to the monitor easily;
- A big tally light is built-in for indicating which camera is PGM or PVW status;
- Support PoE, and 5-18V DC input, powered by USB, power bank or camera easily;

- Configured with 1x SDI input and 1x output interface for view on the monitor while NDI streaming or output while decoding.
- **Support up to 12G SDI video input, to ensure high quality video transmission.**
- Up to 12G SDI resolution;
- Provide standard camera screw to install on the camera;
- Optional control cable/Ethernet for PTZ control over Visca/Visca over IP/Pelco etc. supported (Customize available for other unlisted PTZ protocols);
- NDI high quality coding ensures excellent picture quality, lossless audio coding ensures high fidelity sound quality;
- Precise clock and intelligent algorithms ensure frame synchronization and accurate video and audio synchronization;

## 1.2 Technical Parameters

Item	N30
Input interface	SDI
Output interface	SDI
NDI Features	Up to 12G SDI encoding and decoding.
NDI Encoding and decoding	Support Note: NDI encoding and decoding cannot work simultaneously. When in encoding mode, the output interface will loop the original video.
Network	100/1000Mbps Ethernet Port Support PoE
PTZ control	Support (not available in this version)
Tally	Support
Voice Intercom	Support (not available in this version)
Management type	Web control
Threaded Screw	Standard 1/4" screw(6.5mm)
Power Supply	DC 5V-18V or POE
Power consumption	5W
Working temperature	-20°C~45°C
Dimension	100x80x24mm

## 2 USER GUIDE

- Installation and Connection

Connect the power and video input source correctly, power on the device.

- Network Connection and Configuration

The easiest way for network connection is to connect the device to the network by cable, automatically obtain the IP address and DNS from the network without any settings on the device. After that, use NewTek Studio Monitor and connect the NDI stream of the device, click the gear button () in the lower right corner of the software interface, you can directly open the login link of the encoder WEB page without manually entering the URL. (For the first login or the first login after restoring the factory settings, you will need to agree to the “EULA” that pops up. Otherwise, the NDI stream service of the device cannot be used normally.)

If you want to set the network manually, you can use the default IP address 192.168.1.168 to login the web page and set. The default username and password are “admin/admin”.

- NDI Streaming

NDI has the function of automatic discovery. After the encoder is normally connected to the network, other NDI-supporting tools (such as Newtek studio monitor, OBS, vMix) can automatically discover the encoder and pull the NDI stream directly.

- NDI Decoding

You can switch to the decoding function on the Web page. The device can automatically discover NDI sources in the same network segment, and select the source to decode and output to the monitor. You can also decode and output by means of manually adding NDI sources across network segments or NDI sources from non-default group.

### 3 Packing List and Interface Description

#### 3.1 Packing List

Name	Unit	Quantity
NDI <sup>®</sup> Converter	PCS	1
TYPE-C power cable	PCS	1
TYPE-C to TYPE-A cable	PCS	1
Certificate/ Warranty card	PCS	1
Power adapter	PCS	1
Hot shoe	PCS	1
Quick start guide	PCS	1

#### 3.2 Interface

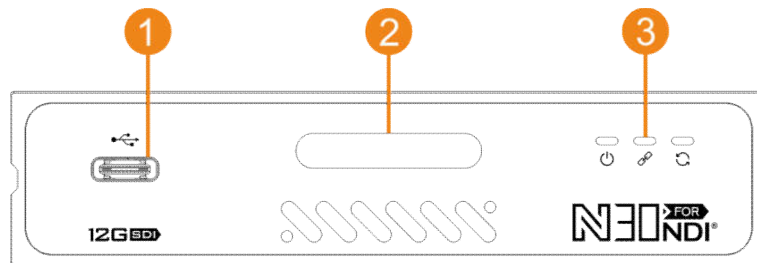

1.TYPE-C expansion port                      2.Tally                      3.Working indicator

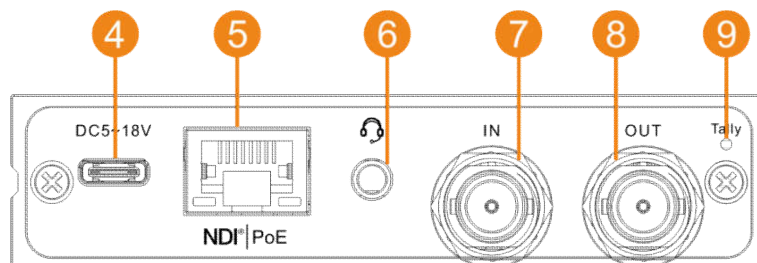



4.1000M Ethernet (PoE)                      5.SDI output                      6.SDI input  
 7.Audio port                      8.TYPE-C power port                      9.Small Tally light

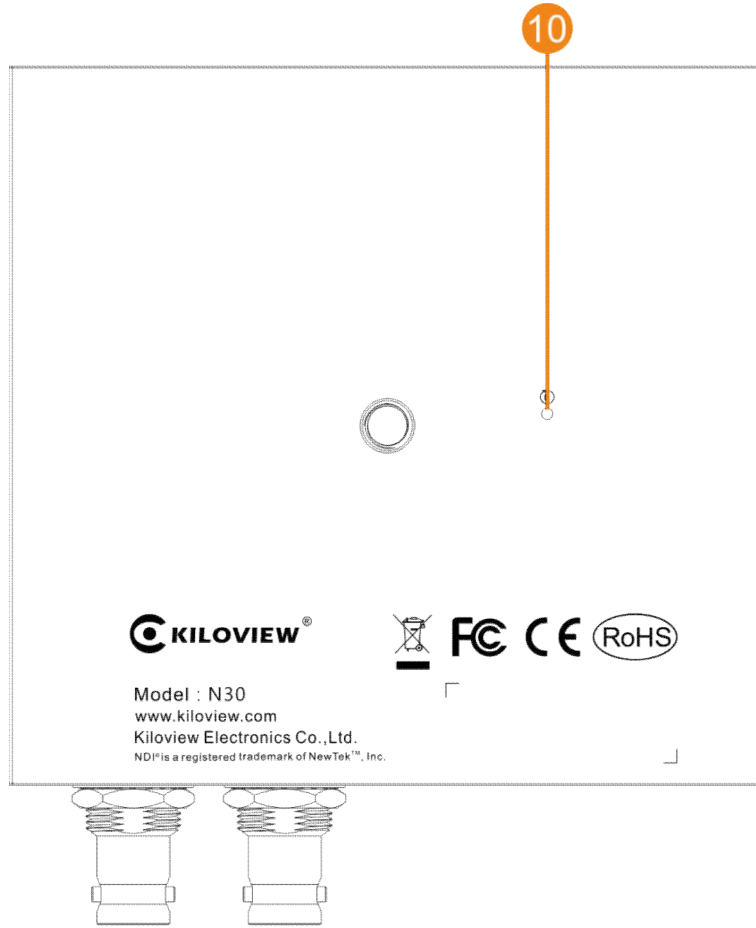



10.Reset button

### 3.3 Led indicators

Icon	Color	Status	Descriptions
	White	Always on	Power connected
		Flashing	Power failure
		Off	No power supplied or power failure
	White	Quick flashing	Network connected
		Slow flashing	Network connection abnormal or when restore device to factory settings (RUN light will be flashing as well)
		Off	Network abnormal or disconnected
	White	Flashing	Device works properly
		Off	The device is abnormal or not started

## 4 Installation and connection

### 4.1 Connect Video Signal

Connect an SDI video cable from a video source (such as a camera) to the N30's SDI input connector. The SDI output is connected to the display device via one SDI cable.

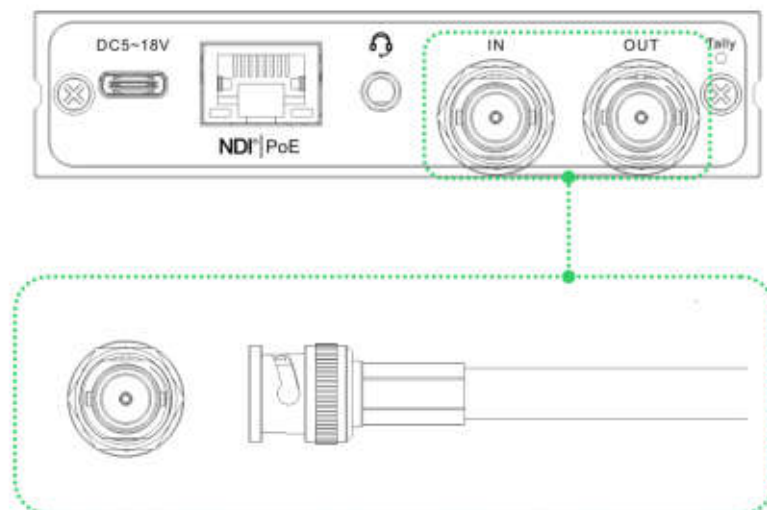

## 4.2 Connect Network

Connect the network cable to Ethernet of the device. The other end of the network cable is connected to the switch. You can also connect directly to the network port of the computer.

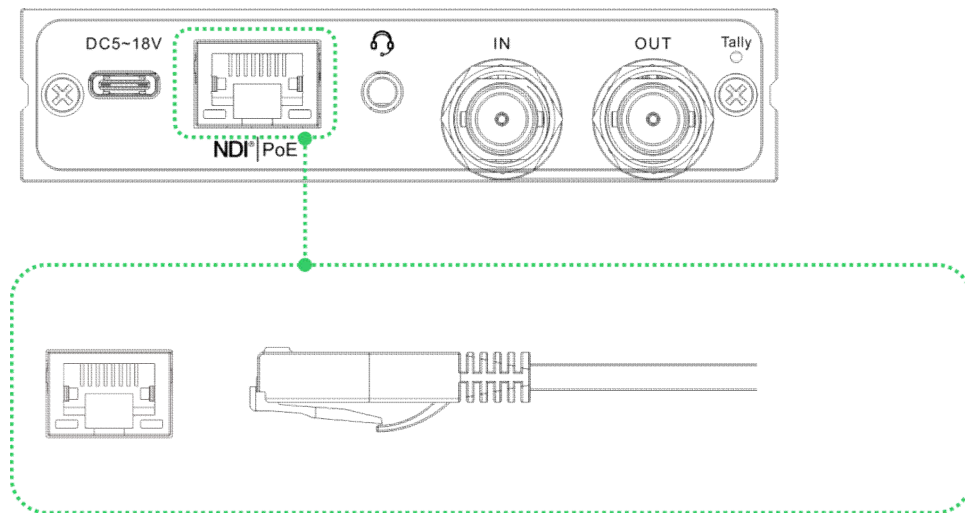

## 4.3 Connect Audio

Using a 3.5mm interface headset with a Microphone to connect to the device or connecting 3.5mm analog audio (Note: Voice intercom function not realized in this version).

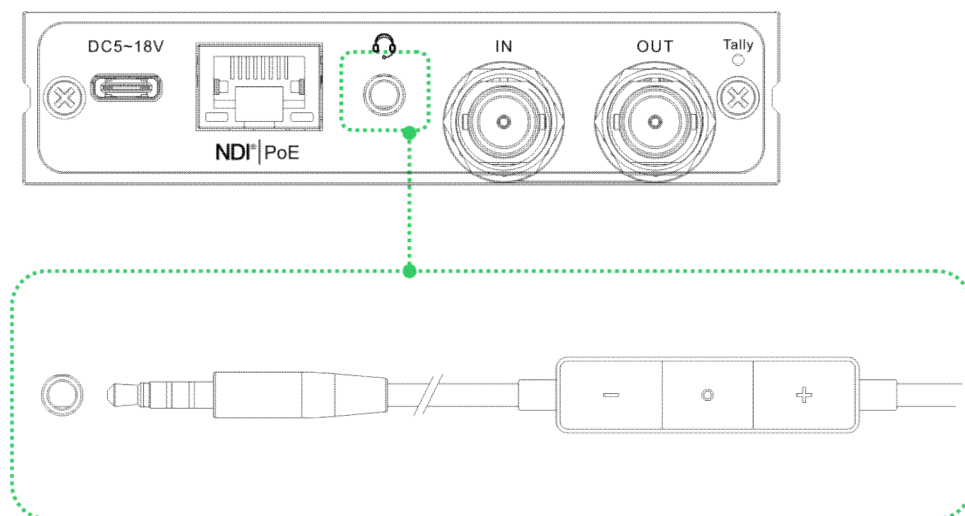

### 4.4 Connect Power Supply

After connecting the power adapter (DC 5V), the power light will be on and the device starts working.

If your switch supports PoE, there is no need to connect to the power supply.

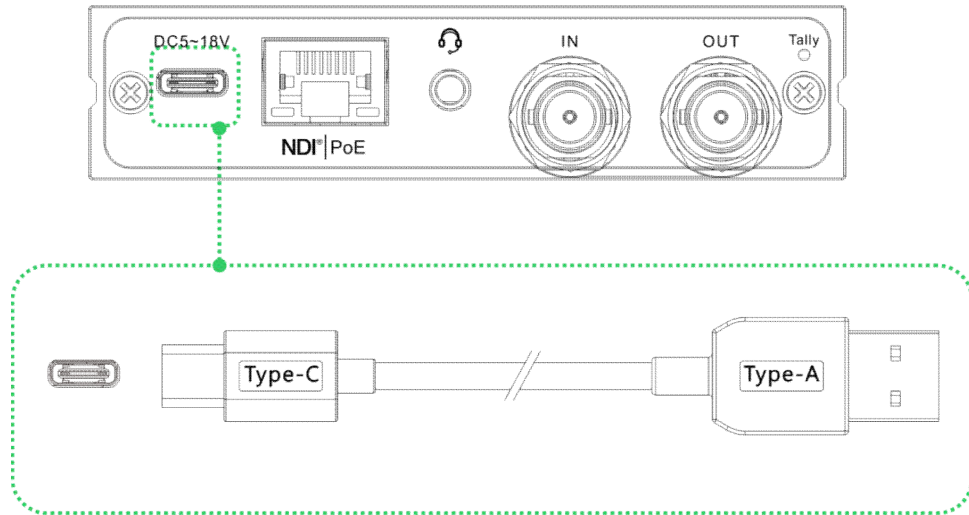

## 5 Login and Network Configuration

### 5.1 Login to the Device via Ethernet

First connect the Ethernet port of the device and the computer to the same switch, or connect the encoder directly to the computer network port. Then configure the encoder and computer to the same network segment so that the computer can access to the web page of the encoder.

The default management IP address of the encoder is 192.168.1.168. (This is the failsafe address of the device. Generally, do not modify this IP address.) If the IP address of the computer is not in the segment of 192.168.1.\*, please set the IP address of the computer network port to 192.168.1.\*.

Open the WEB browser, directly input the IP address of the encoder (default is 192.168.1.168) or the URL <http://192.168.1.168> and press Enter to open the login interface. After opening the Web page, an authentication dialog will pop up, please fill in the username and password, the default username and password is admin/admin, and then click "Login".



**Note:** Due to the browser compatibility issues, it may cause the web page display abnormal, it is recommended to use Chrome or Firefox.

**For the first login or the first login after restoring the factory settings, you will need to agree to the “EULA” that pops up. Otherwise, the NDI stream service cannot be used normally.**

---

After login, the encoding and function parameters can be set on the encoder management web page. The page is shown as below:



## 5.2 Network Configuration

The Ethernet port of the device is connected through the network cable and it can be configured with an IP address. The device network port can be configured with dual IP addresses. The IP address configured here is not the default management IP address. The Ethernet port defaults to DHCP to obtain an IP address. It will automatically obtain a complete IP address, Gateway and DNS according to this LAN.

Click “Network” to view the device Ethernet address configuration and Failsafe address. The Failsafe address is the default management IP address. Generally, you do not need to make special settings.

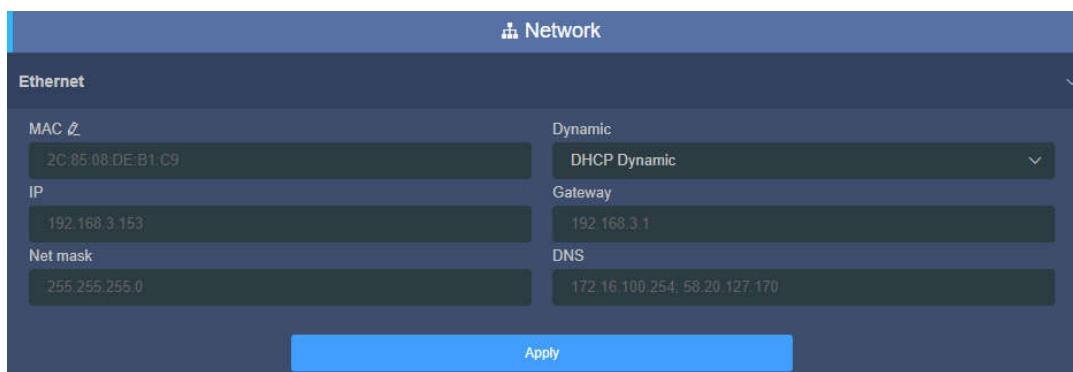

There are two ways to get the address, one is DHCP, and the other is manual setting. To use DHCP to automatically obtain IP, you must first ensure that the router or switch has enabled the DHCP service. This method is simple and convenient, but the IP obtained by DHCP changes continuously, and you cannot directly know what IP address the encoder gets. To set the IP manually, you need to enter a fixed IP to the encoder, and this IP address is fixed as long as the encoder does not restore factory settings, this method is more stable. Therefore, each method has its own advantages, and can be selected accordingly.

### 5.3 Local-link (Failsafe)

The Failsafe is specifically configured with a dedicated IP address on the Ethernet interface (It is the default management IP address of Ethernet port). Even if you forget the Ethernet IP settings, or if the IP address obtained by DHCP cannot be known, you can still connect and access the device through the default IP address.

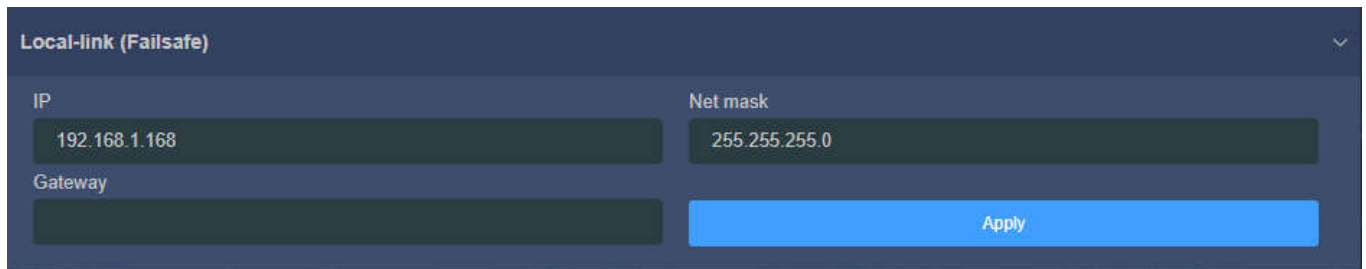

The screenshot shows a configuration window titled "Local-link (Failsafe)". It contains three input fields: "IP" with the value "192.168.1.168", "Net mask" with the value "255.255.255.0", and "Gateway" which is currently empty. A blue "Apply" button is located at the bottom right of the configuration area.

"Failsafe" is to bind the device to an independent IP address. This IP address does not affect the use of other network cards. In special cases, it can be used to manage the encoder. This address can be changed manually (Usually no need to change), the default address is 192.168.1.168.



**Note:** When accessing the device by Failsafe address, your computer must have an IP address in the same network segment.



## 6 NDI discovery and monitor

N30 for NDI converter is a professional video encoding/decoding device for NDI video production. It can convert SDI video source into NDI stream and transmit video through Ethernet for any compatible systems, devices or software in the network.

### 6.1 NDI Tools Installation

Download and install NDI Tools from NewTek website:

<https://www.newtek.com/ndi/tools/#>

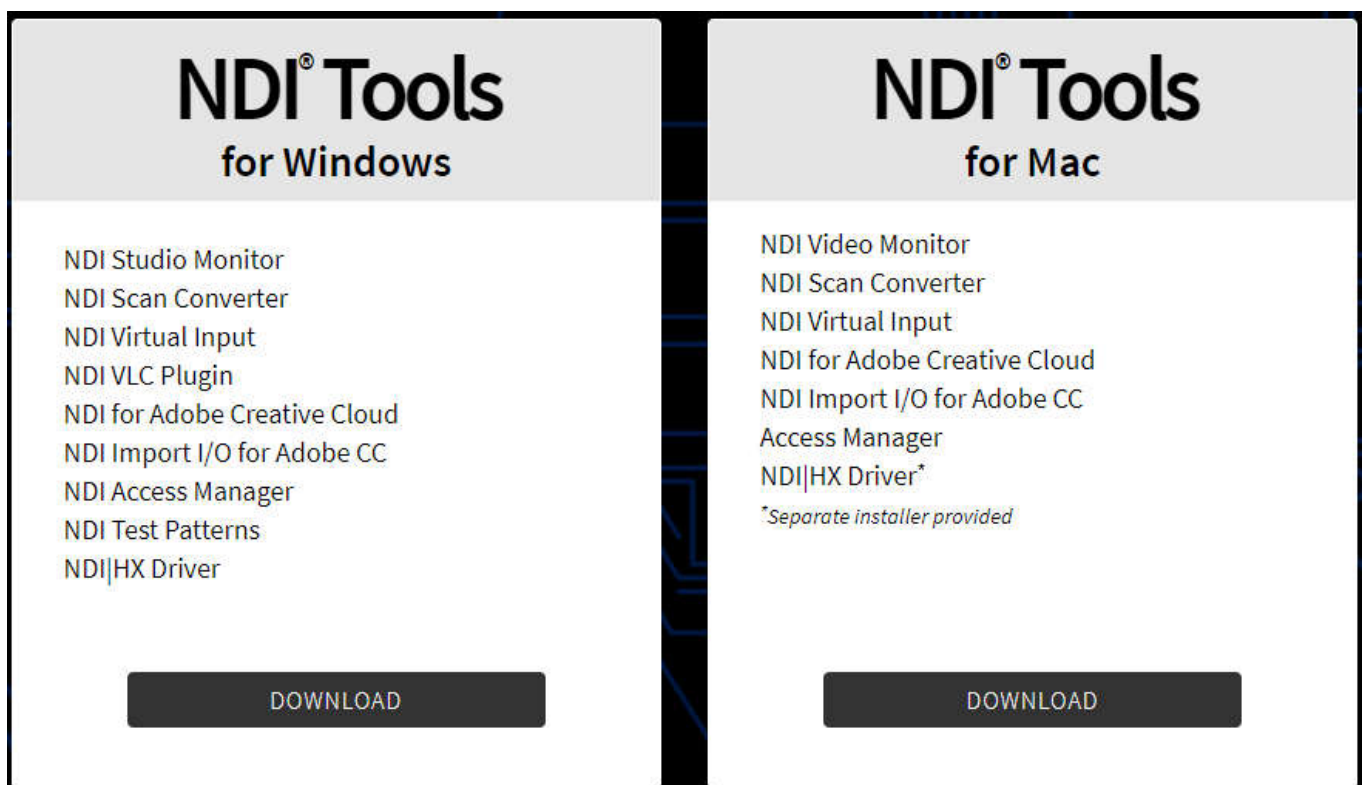



The screenshot displays two side-by-side panels for downloading NDI Tools. The left panel is titled "NDI® Tools for Windows" and lists the following tools: NDI Studio Monitor, NDI Scan Converter, NDI Virtual Input, NDI VLC Plugin, NDI for Adobe Creative Cloud, NDI Import I/O for Adobe CC, NDI Access Manager, NDI Test Patterns, and NDI|HX Driver. A "DOWNLOAD" button is located at the bottom of this panel. The right panel is titled "NDI® Tools for Mac" and lists: NDI Video Monitor, NDI Scan Converter, NDI Virtual Input, NDI for Adobe Creative Cloud, NDI Import I/O for Adobe CC, Access Manager, and NDI|HX Driver\*. A note below the list states "\*Separate installer provided". A "DOWNLOAD" button is also present at the bottom of this panel.

## 6.2 NDI Discovery and Connection

On the PC side, other NDI-enabled tools of the same subnet can discover the encoder automatically. Currently there are many NDI-enabled software. The following is an example of how to automatically discover and pull NDI video streams by using NewTek studio monitor and vMix.

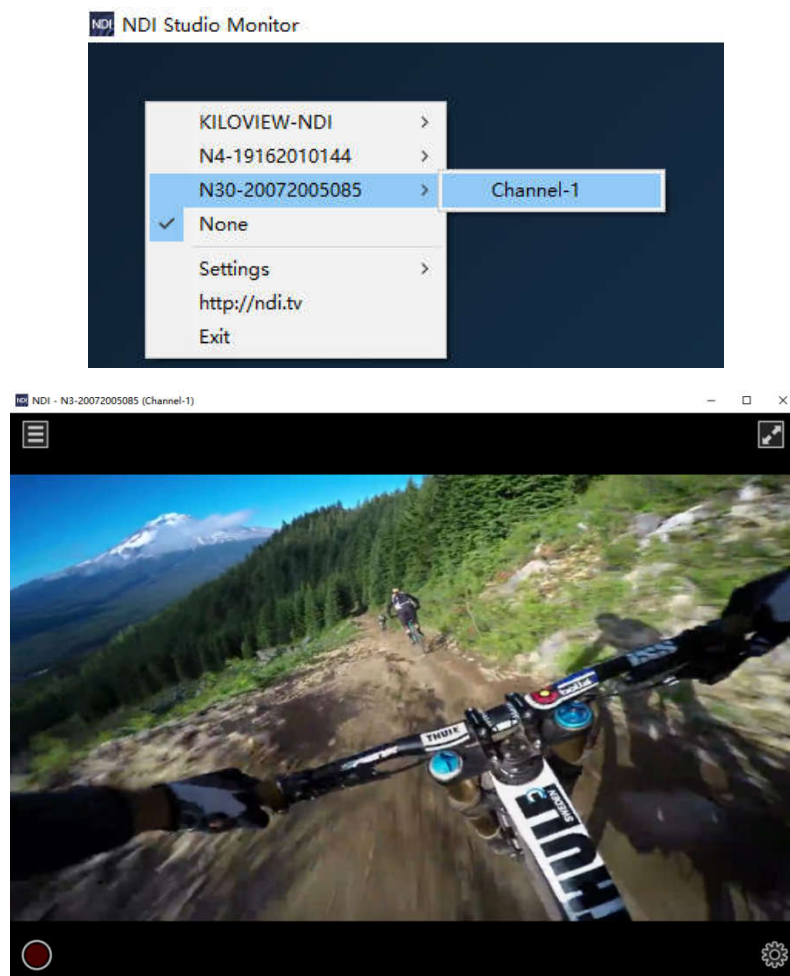
1) Open NewTek studio monitor software, click the icon in the upper left corner to display the list of device names that have been discovered. The device list will be displayed according to different channel names. Select the device you want to connect, and then you can pull the current video stream of the converter.



**⚠ Note:** After opening the selected video of the converter by Studio Monitor, click  in the lower right corner of the player to open the Webpage of the converter directly, which is convenient for the management of the converter.

2) Open vMix, click “Add Input” of the left corner, select “more”, which shows it can add various sources. Click “NDI/desktop capture”, it shows NDI devices list. According to device names and channel names, you could select the device you want to add, then click “OK”, the video source will be added into vMIX play source list.

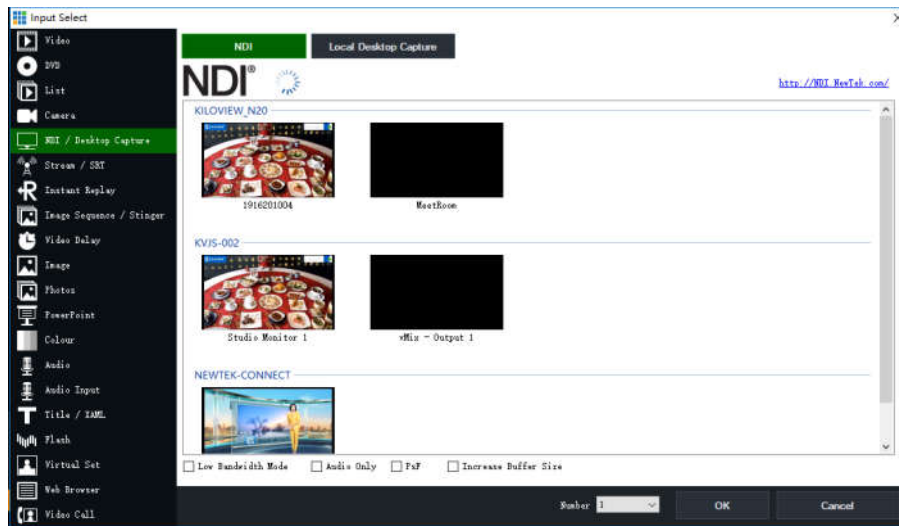

**⚠ Note: NDI discovery is implemented through multicast. Therefore, the NDI converter and other NDI devices should be in the same subnet. The device is configured with the IP address of the same subnet and can communicate with each other (It can be obtained automatically). Otherwise, NDI stream may not be automatically discovered NDI stream.**

### 6.3 NDI Encode Bitrate

The N30 device transmission requires high bit rate, so the device needs to be connected to a Gigabit network. The pulling stream device also needs a Gigabit network. Otherwise, the stream play will be abnormal or not smooth. The following table shows the reference bit rate at different resolution.

Resolution	Coded output bandwidth
4KP60	250Mbps
4KP30	200Mbps
1080P60	125Mbps
720P60	90Mbps

## 7 Encoding Parameter Configuration

### 7.1 Status Column



- Resolution shows the input video resolution
- Framerate shows the input video framerate
- Bitrate shows the real-time encoding bitrate
- Audio format shows the encoding audio sample rate and audio channel

### 7.2 Basic settings

NDI is a protocol developed by NewTek which is used for video over IP in LAN with high image quality and low latency. Set NDI related parameters in “Basic settings”

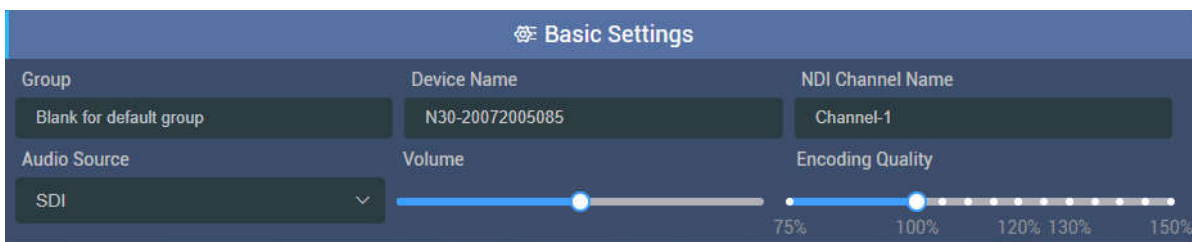

- **Group:** To configure the devices to a group, the name of the group can be the combination of characters and figures. To configure multiple groups is allowed and the group names should be separated by comma (,). The default group name is “public”.
- **Device Name:** The device name of NDI source.
- **NDI channel name:** When there are multiple NDI sources in the same network, as the default channel names are the same, so it’s required to modify the channel name with different parameters to identify each device correctly.

- Audio source: you can select SDI embedded audio (by default) or analog input. Analog audio input can be encoded as audio source, or for intercom (Note: Voice intercom not realized in the version).
- Volume: For gain adjustment of input line-in audio or SDI embedded audio.
- Encoding quality: When the encoding quality is reduced/increased, the encoding quality and encoding bitrate will also be lowered/increased.

**⚠ Note:** It's not required to save after modifying the device group, device name and channel name. After the modification, it will take effect immediately if clicking on other places on the web page.

## 7.3 Advanced settings

### 7.3.1 NDI Connection

If choosing multicast mode, NDI transmission will be executed in multicast mode. Click “Generate”, a multicast IP will be generated randomly, or you can configure it manually and click “Apply” to take effect.

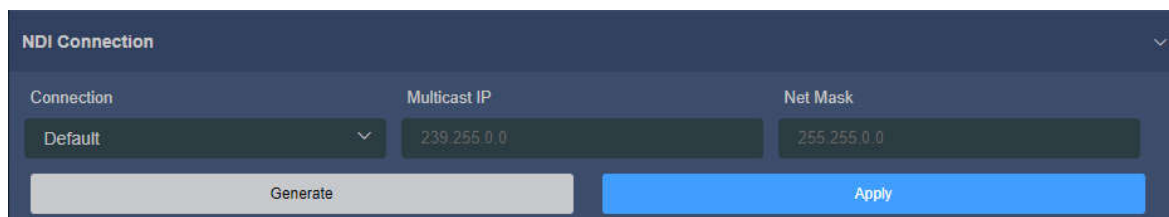

### 7.3.2 PTZ control

The device supports PTZ control, both protocol types of PTZ over Ethernet and serial port are supported.

PTZ over Ethernet needs to correctly configure the protocol address and port of the connected PTZ, and specify the PTZ control protocol (Sony Visca, Pelco-D/P supported).

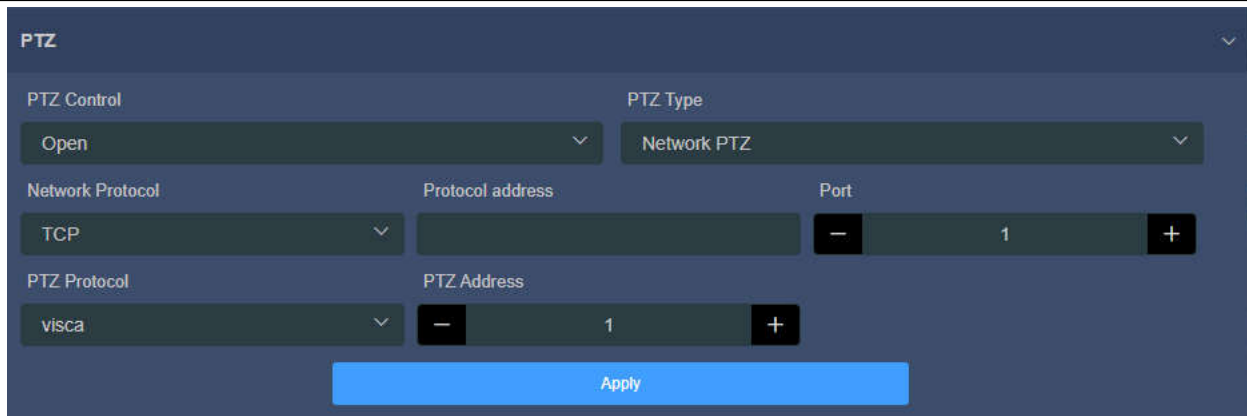

A USB to RS232/RS422/RS485 adaptor is required through TYPE-C to USB. Inserting the USB to RS232/RS422/RS485 adaptor, the device supports PTZ control over serial port.

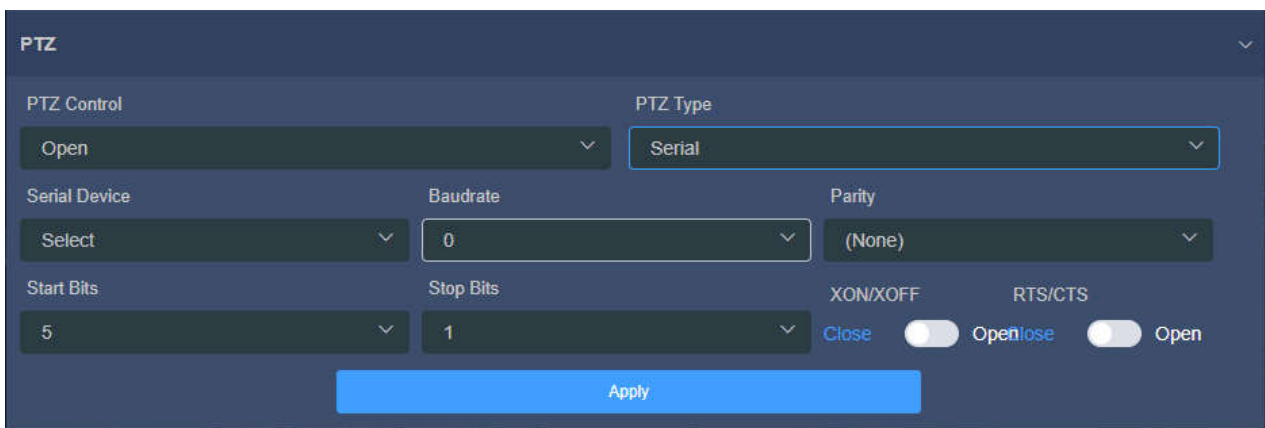

After configuring the control parameters correctly, PTZ control service can be realized by PTZ control panel of NewTek Studio Monitor (Note: It is not available in this version)

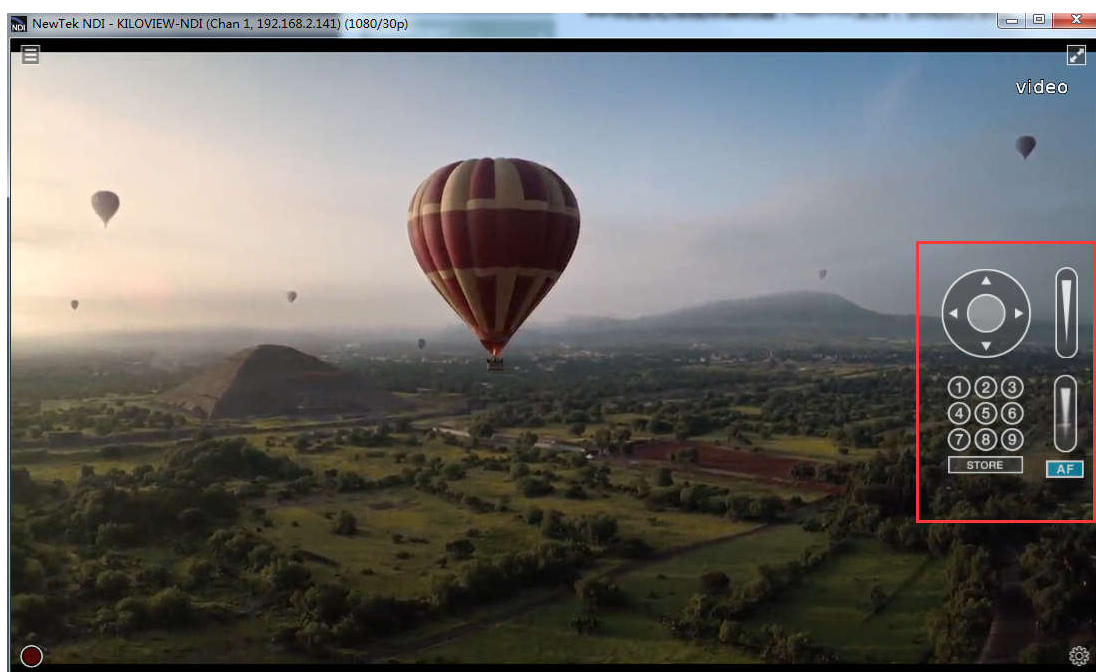

## 8 NDI Decoding Configuration

Click “Decoding” to switch to decoding function on Web Page.

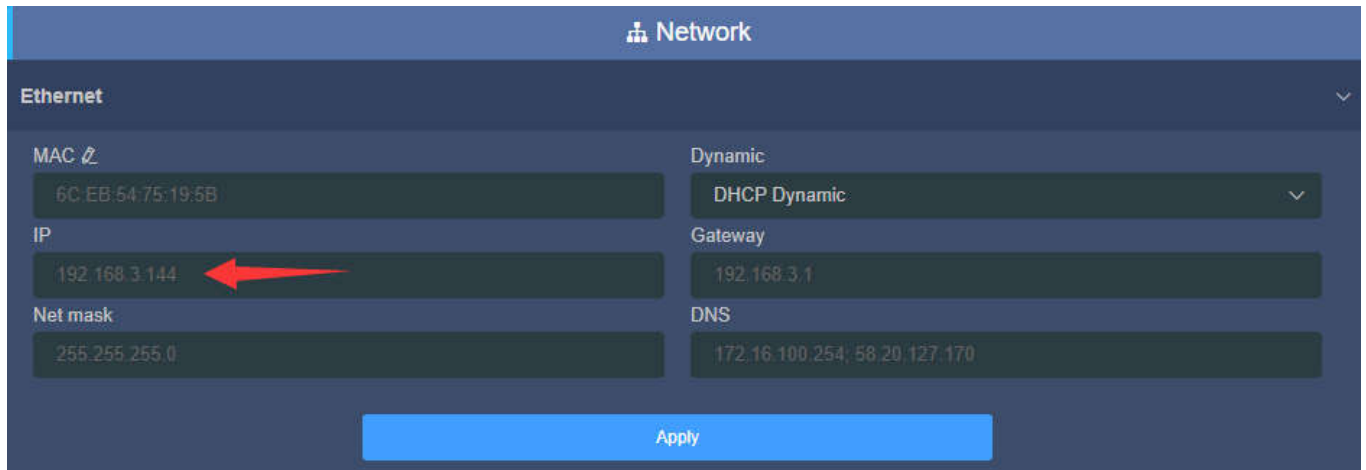

Before using decoding function, please check the Ethernet IP address and log in the WEB page for management with this address, and then switch to decoding function.

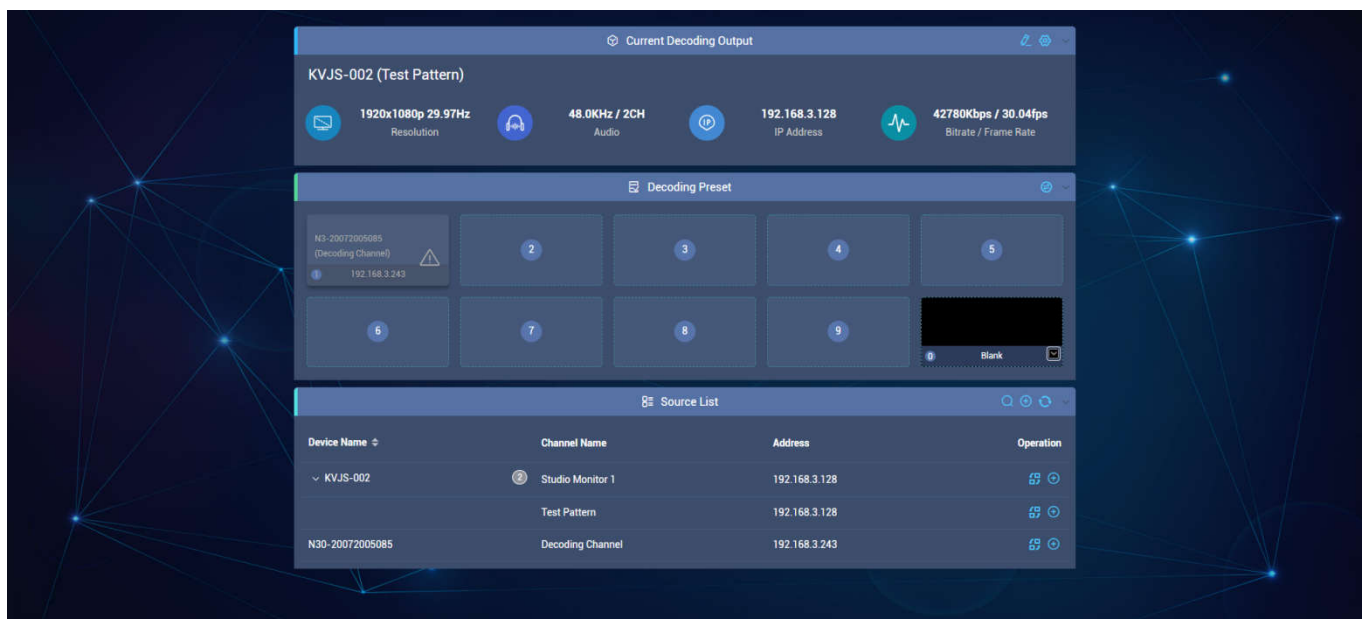

**⚠️ Note:** Encoding and decoding functions of the device cannot be carried out simultaneously. If the device is switched to decoding function, encoding function will be stopped. Decoding mode will generate one NDI stream for discovery, and the channel name is “Decoding Channel”. Using Studio Monitor to connect the NDI stream and click the gear button in the lower right corner to go to the WEB page.



## 8.1 Discover NDI Source

In the same LAN, NDI sources can be displayed in the source list through automatic discovery. Click the icon  to update NDI source in real time. Click the NDI source corresponded icon , you can add the source to the decoding preset box; Click the NDI source corresponded icon , which can directly decode and output the video.

Device Name	Channel Name	Address	Operation
KVJS-002	Studio Monitor 1	192.168.3.128	 
	Test Pattern	192.168.3.128	 
N30-20072005085	Decoding Channel	192.168.3.243	 

Click  to add NDI sources from different groups or different network segments in the same local area network.

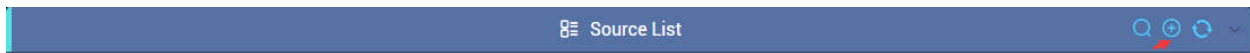

If you want to search for devices with different group names in the same subnet, filling in the specified group name in "Group" box, then click the "Enter" button. At this time, two group names will be displayed in the "Group" box, and then click "OK" (no need to fill in the IP address), the device will search for the NDI sources of these two group names at the same time. (You are allowed to add multiple group names to search)

### Add a Source Manually

Group

---

IP



Manually Added Source List

OK
Cancel



When you need to search for NDI sources across network segments, if the group name is a non-public group, you need to fill in the specified group name firstly, and then fill in the specified IP address in the "IP" box, click the button , this IP address will be added to the "Manual Scan Address List". You can add multiple IP addresses to search at the same time, and then press "OK" to save.

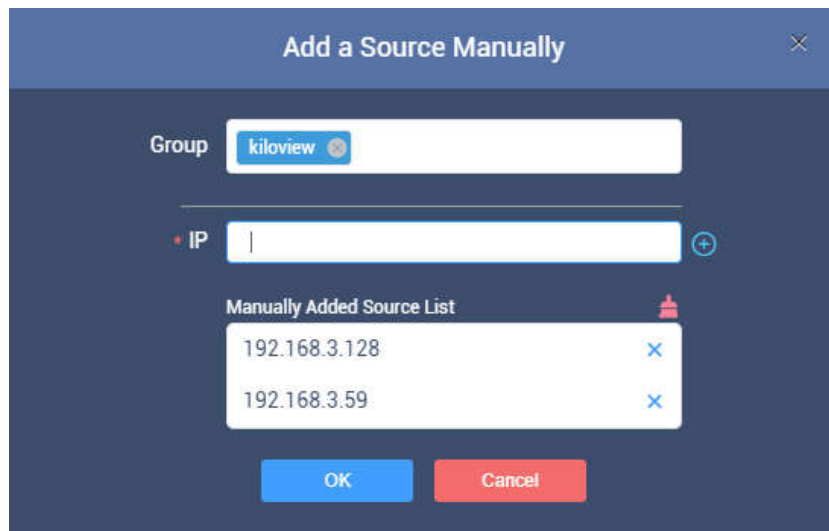

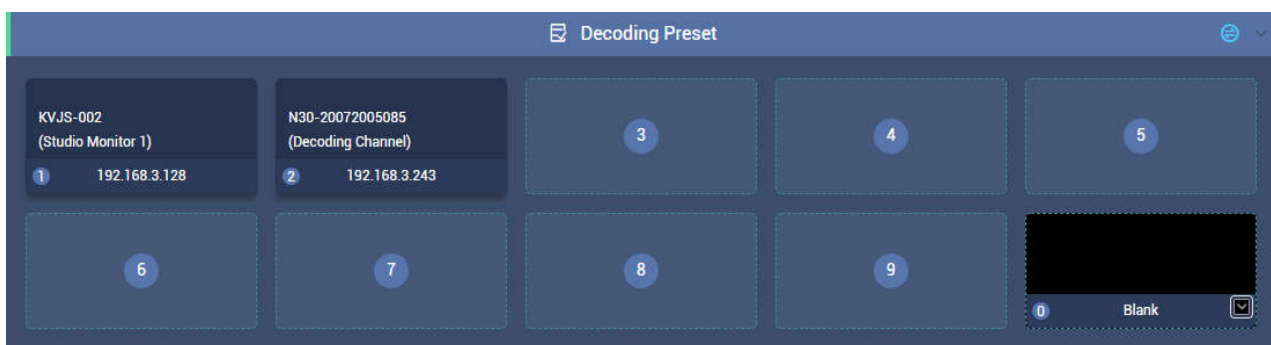

## 8.2 Output of NDI decoding

You can add up to nine preset decoding sources, by clicking the NDI sources, the device will start decoding the corresponding NDI source. It can be quickly switched and decoded by clicking different NDI sources. By clicking x in the upper right corner of the NDI source in the preset box, you can delete the added source.

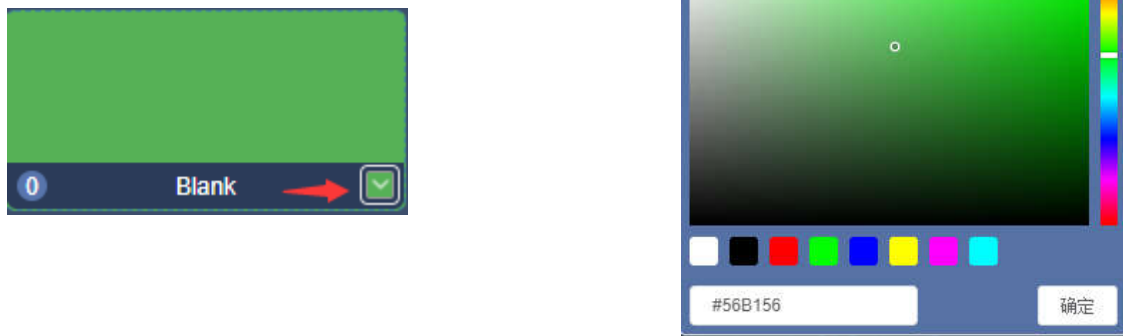

There is a blank output box in decoding preset, if switching to a source without video output, the device will output the set color. It can also be used for testing the output to the monitor by choosing different color.



Click the icon  on the right to set parameters for smooth switch. To make sure the smooth switch, if it is a big video or slow transmission, a longer smooth time can be set. Otherwise it will show the blank screen set previously when output is not ready after switching.

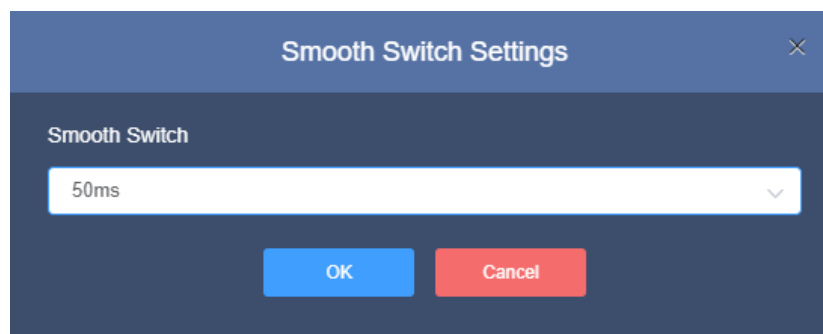

The decoding output switch can also be controlled via keypad (connect with USB), and first you need to connect the keypad by USB.



Press **【NumLock】** on the keypad, if the light is on, you can operate the decoding switch. Press 1~9 to select the corresponding 1~9 preset decoding source, and press 0 to select blank output.

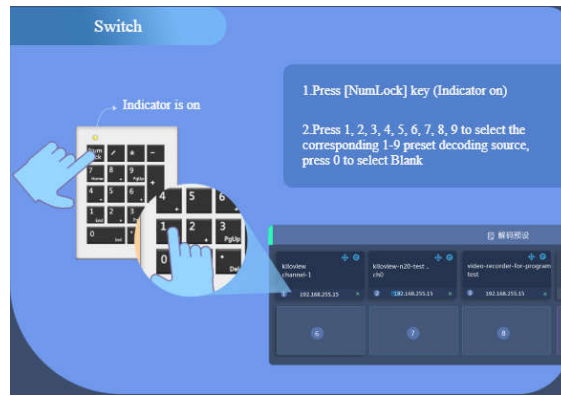

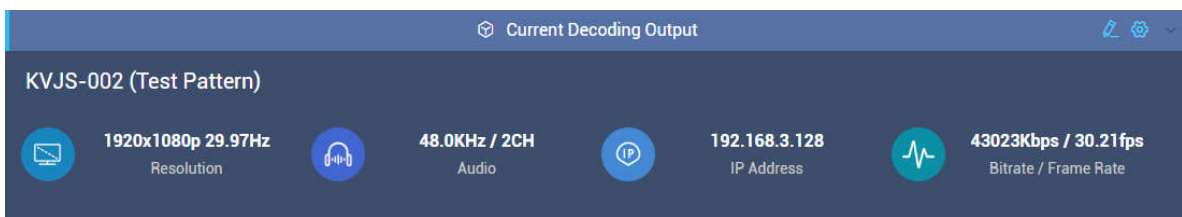

### 8.3 Decoding Parameters Setting

“Current decoding output” will display the information of the current decoding NDI source name, channel name, resolution/refresh rate, audio parameters, source IP address, real time bit rate and frame rate and so on.

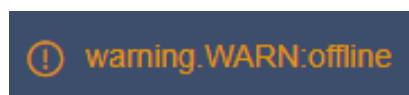

If the current decoding source is disconnected, a warning notice will be displayed at the up-right corner showing the device is offline.



Click  on the right, you can configure the output parameters. The resolution of decoding output will be the same as that of the source. Frame rate and audio sample rate can be set accordingly.

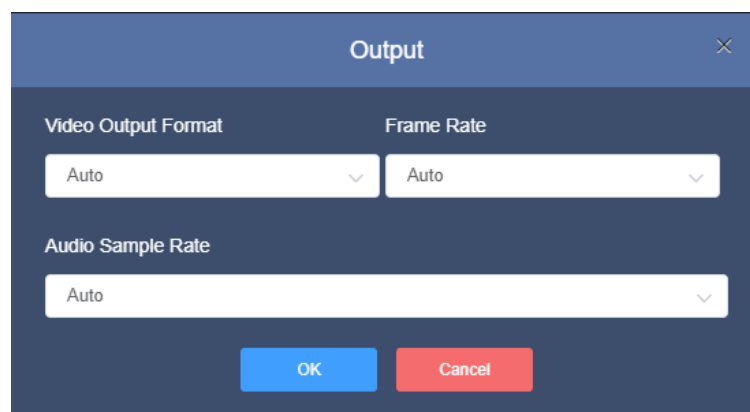

## 8.4 Discovery service

NDI discovery server can replace NDI auto discovery with server. All NDI sources are registered with server in a centralized way, and the receiving end obtains NDI source from the server. Through this, the device can also send the output video stream to the receiving end of the cross-network segment.

First, download and install the NDI SDK on a Windows computer at the receiving end. After installation, run bin/ utilities/x64/NDI discovery Service.exe.



NDI encoder configures the receiving IP address in the discovery server, and NDI will be registered with the server. It is recommended that the receiving address should be configured as a static IP address to prevent the loss of NDI connection due to IP reallocation



### 1) Receiving via Kiloview FULL NDI decoder

Switch the FULL NDI device to decoding mode, click "discover server", and "Enable" it.

Fill in the server address with the same registered address of the NDI encoder. Click "OK", all NDI sources registered to the discovery server can be found by scanning the list.

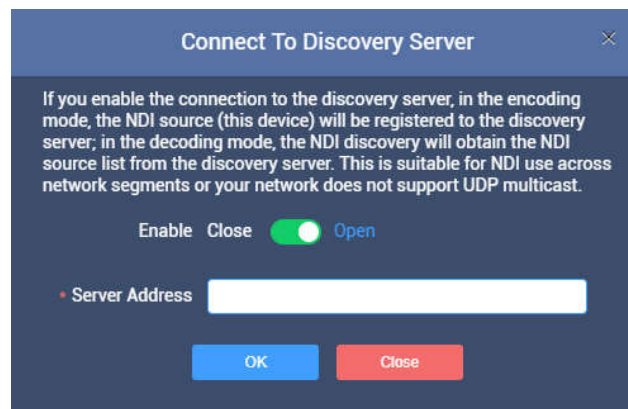

## 2) Receiving via computer-based software

Install NDI tools on the receiving end and open “NDI access manager”. Click to enter the "advanced", cancel the "multicast sending enabled" function, select "Use discovery server", and set the "Server IP" address to the IP address of your computer that enables the discovery server function. After configured, the receiving end can discover the NDI stream registered with the server.

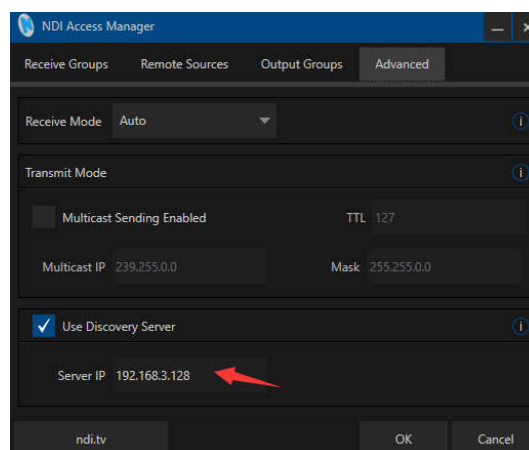

**Note:** after this function is enabled, the mDNS auto discovery function is invalid. The stream of the decoder can only be sent to the specified server, and the receiver end must register with the same discovery server to pull the NDI stream.

## 9 System Settings

### 9.1 User Management

You can add and delete users, modify the user password and so on.

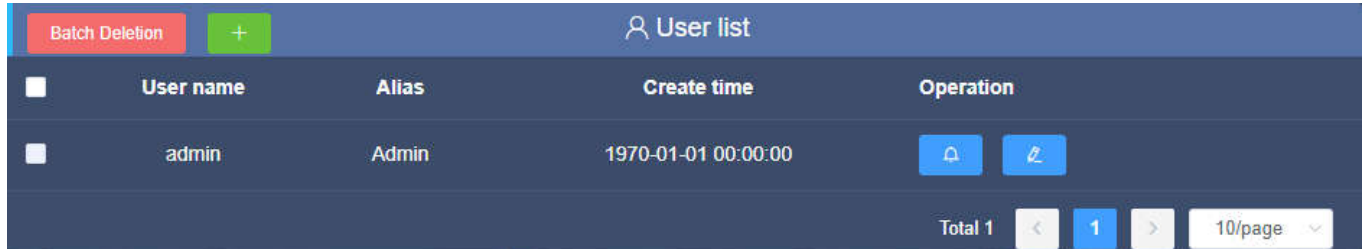

<input type="checkbox"/>	User name	Alias	Create time	Operation
<input type="checkbox"/>	admin	Admin	1970-01-01 00:00:00	<input type="button" value="🔔"/> <input type="button" value="🔗"/>

Total 1    10/page

### 9.2 Quick Reset

"Quick reset" is used to reset the coding service. It is usually applied after the parameters modifications to take effect immediately or abnormal encoding/decoding. It takes about 3 seconds and current coding service will be interrupted.

### 9.3 Reboot

“Reboot” is used to restart device software, which means restart the device. The processing takes about one minute.

### 9.4 Restore Factory Settings

If the device can't work properly after parameters modification (typical case: after modifying the IP address which makes network un-accessible to the device), you can restore the factory settings to the default parameters.

#### Two Ways of Restore Factory Settings:

- 1) In Web page, select “System Setup”> “Restore”.
- 2) RESET Button: Press the reset button at the bottom of the device and hold the for more than 5 seconds. The device will be restored to the factory settings. Restoring the factory settings will lead to a hard reboot and the reboot process will take

approximately one minute.

## 9.5 Firmware Upgrade

Our product will be constantly improved, so we will continue to upgrade the device for bug fixing. Please contact our technical support to obtain the upgrade package or download it on our website.

Click “System Setup”, select “Firmware” go to the firmware upgrade interface. After uploading the firmware to the device, click "Upgrade" to start. The entire upgrade process will last for 2-3 minutes (depending on the firmware size and network conditions). The device will automatically restart, remember not to power off during the upgrade process, otherwise the upgrade may fail and the device will be abnormal. If you need help, please contact our technical support to complete the upgrade.

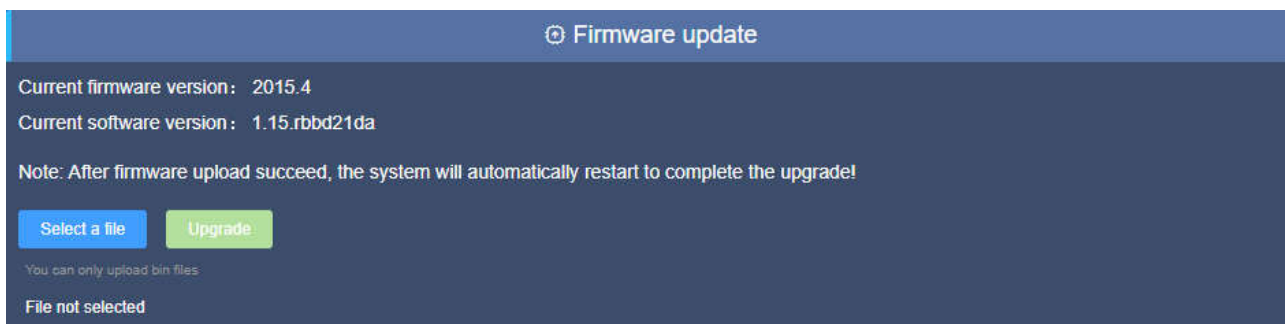

After upgrading, click  at the upper right corner of the WEB page to confirm whether the current software version and the latest upgrade package are the same, to make ensure the device upgrading is successful.

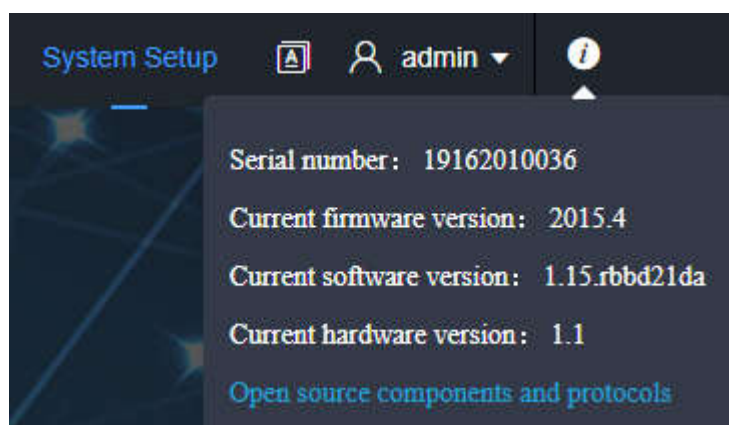

**Thank you for reading!**

**Changsha KILOVIEW Electronics CO.,LTD.**

Tel: 86-731-88315979

Website: [en.kiloview.com](http://en.kiloview.com)

Technical support Email: [support@kiloview.com](mailto:support@kiloview.com)

Skype: kiloview-support/keqiu wang

WhatsApp: +86-18573195156/18573195256

Address: 188#, Middle Huanbao Rd, Yuhua District, Changsha, Hunan Province, China