

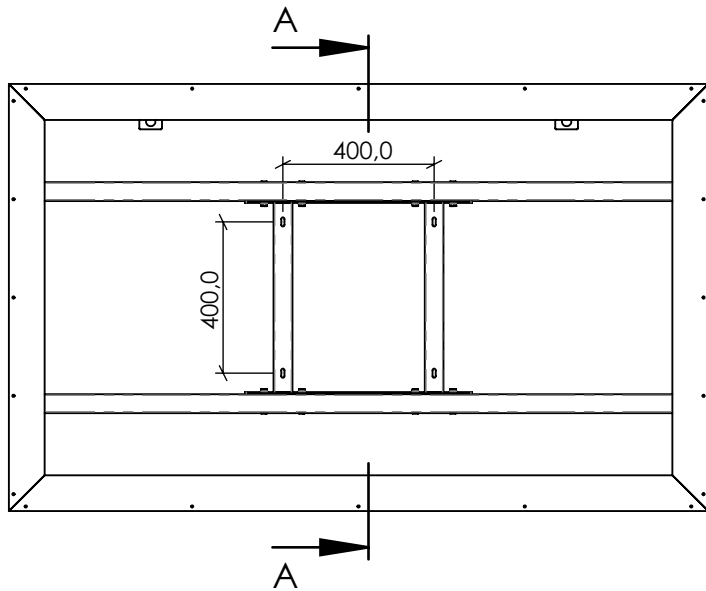

0521-220126-01-Moldura 75-Aprov. Cliente

Vista geral

Dimensões em milímetros

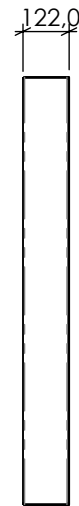
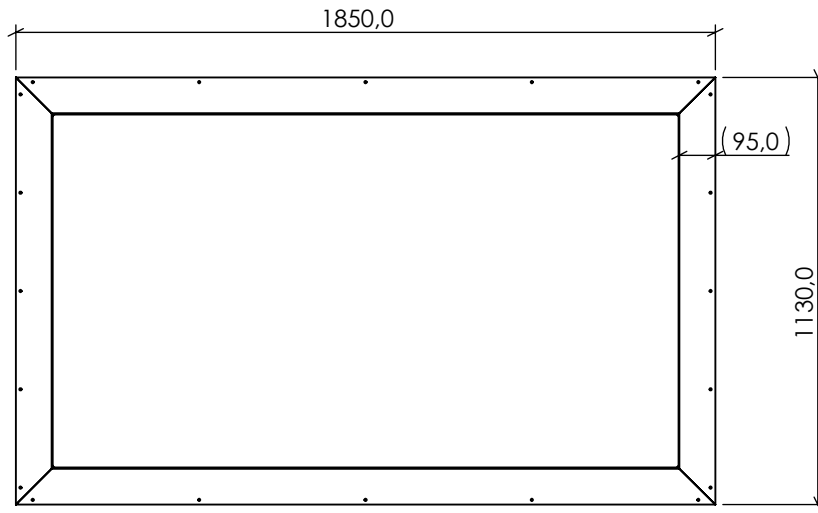

SECTION A-A

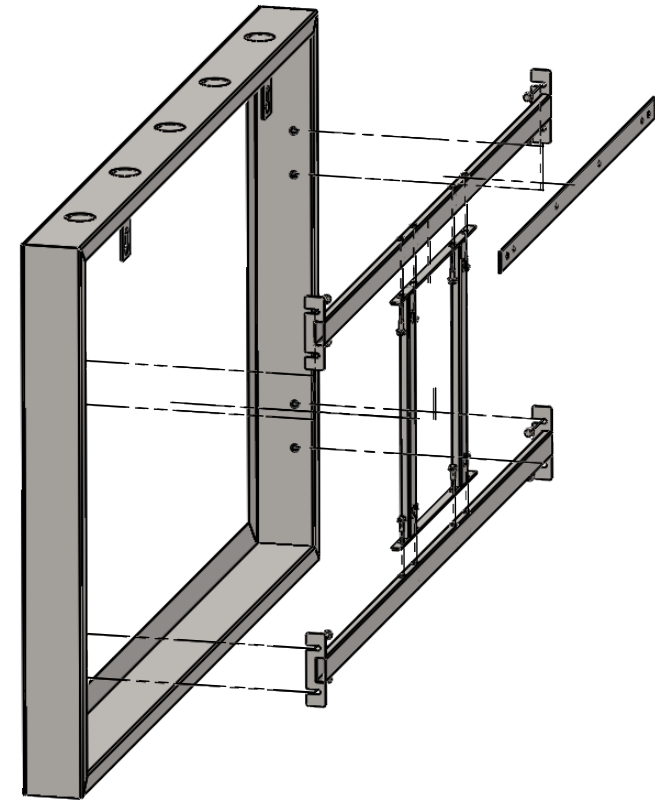

Desenhado por: Paulo Durana

Data: 14/02/2022