

Operating Instructions **Excerpted Version**

Control Panel

Model No. **AV-HS60C4P**

Model No. **AV-HS60C4E**

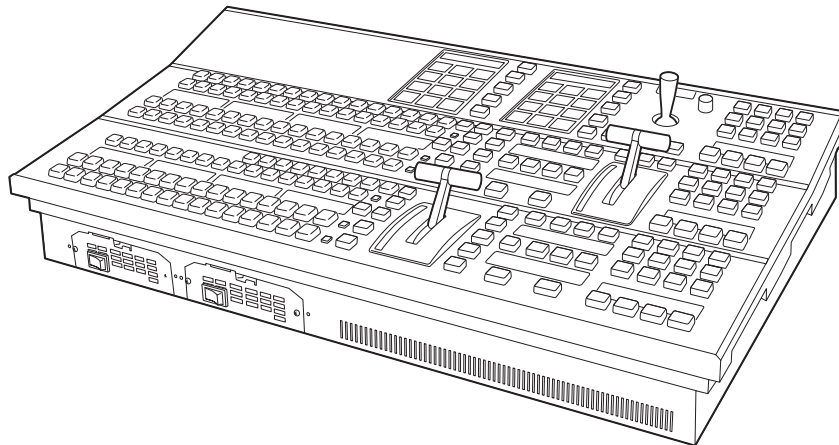

This manual is an excerpted version of the Operating Guide. For more information, please visit the Panasonic website (<http://pro-av.panasonic.net/en/manual/index.html>), and refer to the Operating Guide (PDF).

Before operating this product, please read the instructions carefully and save this manual for future use. Please carefully read the "Read this first!" (P. 2 to 6) of this Manual before use.

Read this first! (For AV-HS60C4P)

 indicates safety information.

WARNING:

Installation should only be performed by qualified installation personnel.
Improper installation may result in the entire apparatus falling down and causing injury.



CAUTION: TO REDUCE THE RISK OF ELECTRIC SHOCK,
DO NOT REMOVE COVER (OR BACK).
NO USER SERVICEABLE PARTS INSIDE.
REFER TO SERVICING TO QUALIFIED SERVICE PERSONNEL.



The lightning flash with arrowhead symbol, within an equilateral triangle, is intended to alert the user to the presence of uninsulated "dangerous voltage" within the product's enclosure that may be of sufficient magnitude to constitute a risk of electric shock to persons.



The exclamation point within an equilateral triangle is intended to alert the user to the presence of important operating and maintenance (servicing) instructions in the literature accompanying the appliance.

WARNING:

This equipment must be grounded.
To ensure safe operation, the three-pin plug must be inserted only into a standard three-pin power outlet which is effectively grounded through normal household wiring.
Extension cords used with the equipment must have three cores and be correctly wired to provide connection to the ground. Wrongly wired extension cords are a major cause of fatalities.
The fact that the equipment operates satisfactorily does not imply that the power outlet is grounded or that the installation is completely safe. For your safety, if you are in any doubt about the effective grounding of the power outlet, please consult a qualified electrician.

WARNING:

- To reduce the risk of fire or electric shock, do not expose this equipment to rain or moisture.
- To reduce the risk of fire or electric shock, keep this equipment away from all liquids. Use and store only in locations which are not exposed to the risk of dripping or splashing liquids, and do not place any liquid containers on top of the equipment.

WARNING:

This equipment is compliant with Class A of CISPR 32.
In a residential environment this equipment may cause radio interference.

WARNING:

Always keep switch blank caps (large)/(small) and memory cards (optional accessories) out of the reach of babies and small children.

WARNING:

Fuse replacement should only be performed by qualified personnel.
For continued protection against risk of fire, replace only with the same type; 3.15 AH - 250 V fuse for F1/F2.

CAUTION:

To reduce the risk of fire or electric shock and annoying interference, use the recommended accessories only.

CAUTION:

In order to maintain adequate ventilation, do not install or place this unit in a bookcase, built-in cabinet or any other confined space. To prevent risk of electric shock or fire hazard due to overheating, ensure that curtains and any other materials do not obstruct the ventilation.

CAUTION:

The mains plug of the power supply cord shall remain readily operable.
The AC receptacle (mains socket outlet) shall be installed near the equipment and shall be easily accessible. To completely disconnect this equipment from the AC mains, disconnect the power cord plug from the AC receptacle.

CAUTION:

This apparatus can be operated at a voltage in the range of 100 – 240 V AC.
Voltages other than 120 V are not intended for U.S.A. and Canada.
Operation at a voltage other than 120 V AC may require the use of a different AC plug. Please contact either a local or foreign Panasonic authorized service center for assistance in selecting an alternate AC plug.



indicates safety information.

CAUTION:

Naked flame sources, such as lighted candles, should not be placed on the apparatus.

Use the apparatus in tropical and/or moderate climates.

FCC NOTICE (USA)

This device complies with part 15 of the FCC Rules.

Operation is subject to the following two conditions:

(1) This device may not cause harmful interference, and (2) this device must accept any interference received, including interference that may cause undesired operation.

FCC Note:

This equipment has been tested and found to comply with the limits for a class A digital device, pursuant to Part 15 of the FCC Rules. These limits are designed to provide reasonable protection against harmful interference when the equipment is operated in a commercial environment. This equipment generates, uses, and can radiate radio frequency energy, and if not installed and used in accordance with the instruction manual, may cause harmful interference to radio communications. Operation of this equipment in a residential area is likely to cause harmful interference in which case the user will be required to correct the interference at his own expense.

Warning:

To assure continued FCC emission limit compliance, the user must use only shielded interface cables when connecting to external units. If DVI-D port is to be used it must be connected to PC by compatible interface cable with two ferrite cores. Also, any unauthorized changes or modifications to this equipment could void the user's authority to operate it.

NOTIFICATION (Canada)

CAN ICES-003(A)/NMB-003(A)

IMPORTANT SAFETY INSTRUCTIONS

- 1) Read these instructions.
- 2) Keep these instructions.
- 3) Heed all warnings.
- 4) Follow all instructions.
- 5) Do not use this apparatus near water.
- 6) Clean only with dry cloth.
- 7) Do not block any ventilation openings. Install in accordance with the manufacturer's instructions.
- 8) Do not install near any heat sources such as radiators, heat registers, stoves, or other apparatus (including amplifiers) that produce heat.
- 9) Do not defeat the safety purpose of the polarized or grounding-type plug. A polarized plug has two blades with one wider than the other. A grounding-type plug has two blades and a third grounding prong. The wide blade or the third prong are provided for your safety. If the provided plug does not fit into your outlet, consult an electrician for replacement of the obsolete outlet.
- 10) Protect the power cord from being walked on or pinched particularly at plugs, convenience receptacles, and the point where they exit from the apparatus.
- 11) Only use attachments/accessories specified by the manufacturer.
- 12) Use only with the cart, stand, tripod, bracket, or table specified by the manufacturer, or sold with the apparatus. When a cart is used, use caution when moving the cart/apparatus combination to avoid injury from tip-over.
- 13) Unplug this apparatus during lightning storms or when unused for long periods of time.
- 14) Refer all servicing to qualified service personnel. Servicing is required when the apparatus has been damaged in any way, such as power-supply cord or plug is damaged, liquid has been spilled or objects have fallen into the apparatus, the apparatus has been exposed to rain or moisture, does not operate normally, or has been dropped.



S8125A

Read this first! (For AV-HS60C4E)

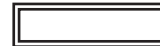

indicates safety information.

WARNING:

Installation should only be performed by qualified installation personnel.
Improper installation may result in the entire apparatus falling down and causing injury.

WARNING:

This equipment must be earthed.
To ensure safe operation, the three-pin plug must be inserted only into a standard three-pin power point which is effectively earthed through the normal household wiring.
Extension cords used with the equipment must have three cores and be correctly wired to provide connection to the earth. Wrongly wired extension cords are a major cause of fatalities.
The fact that the equipment operates satisfactorily does not imply that the power point is earthed or that the installation is completely safe. For your safety, if you are in any doubt about the effective earthing of the power point, please consult a qualified electrician.

WARNING:

- To reduce the risk of fire or electric shock, do not expose this equipment to rain or moisture.
- To reduce the risk of fire or electric shock, keep this equipment away from all liquids. Use and store only in locations which are not exposed to the risk of dripping or splashing liquids, and do not place any liquid containers on top of the equipment.

WARNING:

Always keep switch blank caps (large)/(small) and memory cards (optional accessories) out of the reach of babies and small children.

WARNING:

Fuse replacement should only be performed by qualified personnel.
For continued protection against risk of fire, replace only with the same type; 3.15 AH - 250 V fuse for F1/F2.

WARNING:

This equipment is compliant with Class A of CISPR 32.
In a residential environment this equipment may cause radio interference.

CAUTION:

Do not remove panel covers by unscrewing.
To reduce the risk of electric shock, do not remove the covers. No user serviceable parts inside.
Refer servicing to qualified service personnel.

CAUTION:

To reduce the risk of fire or electric shock and annoying interference, use the recommended accessories only.

CAUTION:

In order to maintain adequate ventilation, do not install or place this unit in a bookcase, built-in cabinet or any other confined space. To prevent risk of electric shock or fire hazard due to overheating, ensure that curtains and any other materials do not obstruct the ventilation.

CAUTION:

The mains plug of the power supply cord shall remain readily operable.
The AC receptacle (mains socket outlet) shall be installed near the equipment and shall be easily accessible. To completely disconnect this equipment from the AC mains, disconnect the power cord plug from the AC receptacle.

CAUTION:

Naked flame sources, such as lighted candles, should not be placed on the apparatus.

Use the apparatus in tropical and/or moderate climates.

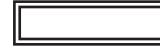

indicates safety information.

Caution for AC Mains Lead

FOR YOUR SAFETY PLEASE READ THE FOLLOWING TEXT CAREFULLY.

This product is equipped with 2 types of AC mains cable. One is for continental Europe, etc. and the other one is only for U.K.

Appropriate mains cable must be used in each local area, since the other type of mains cable is not suitable.

FOR CONTINENTAL EUROPE, ETC.

Not to be used in the U.K.

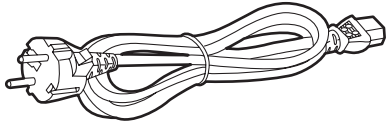

FOR U.K. ONLY

If the plug supplied is not suitable for your socket outlet, it should be cut off and appropriate one fitted.

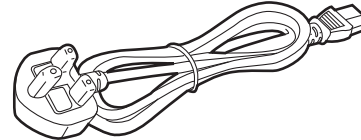

FOR U.K. ONLY

This appliance is supplied with a moulded three pin mains plug for your safety and convenience.

A 13 amp fuse is fitted in this plug.

Should the fuse need to be replaced please ensure that the replacement fuse has a rating of 13 amps and that it is approved by ASTA or BSI to BS1362.

Check for the ASTA mark  or the BSI mark  on the body of the fuse.

If the plug contains a removable fuse cover you must ensure that it is refitted when the fuse is replaced.

If you lose the fuse cover the plug must not be used until a replacement cover is obtained.

A replacement fuse cover can be purchased from your local Panasonic Dealer.

How to replace the fuse

1. Open the fuse compartment with a screwdriver.

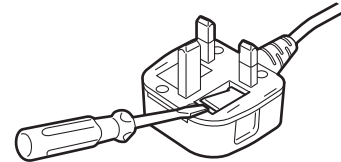

2. Replace the fuse.

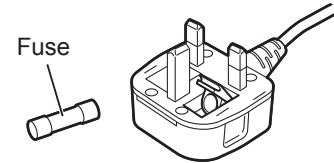

AEEE Yönetmeliğine Uygundur.
AEEE Complies with Directive of Turkey.

Manufactured by:

Panasonic Connect Co., Ltd.
4-1-62 Minoshima, Hakata-ku, Fukuoka 812-8531, Japan

Importer:

Panasonic Connect Europe GmbH
Authorized Representative in EU:
Panasonic Testing Centre
Winsbergring 15, 22525 Hamburg, Germany

Importer for UK:

Panasonic Connect UK,
a branch of Panasonic Connect Europe GmbH,
Maxis 2, Western Road, Bracknell, Berkshire, RG12 1RT

**UK
CA**

EMC NOTICE FOR THE PURCHASER/USER OF THE APPARATUS

1. Pre-requisite conditions to achieving compliance with the above standards

<1> Peripheral equipment to be connected to the apparatus and special connecting cables

- The purchaser/user is urged to use only equipment which has been recommended by us as peripheral equipment to be connected to the apparatus.
- The purchaser/user is urged to use only the connecting cables described below.

<2> For the connecting cables, use shielded cables which suit the intended purpose of the apparatus.

- Video signal connecting cables
Use double shielded coaxial cables, which are designed for 75-ohm type high-frequency applications, for SDI (Serial Digital Interface).
Coaxial cables, which are designed for 75-ohm type high-frequency applications, are recommended for analog video signals.
- Audio signal connecting cables
If your apparatus supports AES/EBU serial digital audio signals, use cables designed for AES/EBU.
Use shielded cables, which provide quality performance for high-frequency transmission applications, for analog audio signals.
- Other connecting cables (IEEE1394, USB)
Use double shielded cables, which provide quality performance for high-frequency applications, as connecting cables.
- When connecting to the DVI signal terminal, use a cable with a ferrite core.
- If your apparatus is supplied with ferrite core(s), they must be attached on cable(s) following instructions in this manual.

2. Performance level

The performance level of the apparatus is equivalent to or better than the performance level required by these standards.

However, the apparatus may be adversely affected by interference if it is being used in an EMC environment, such as an area where strong electromagnetic fields are generated (by the presence of signal transmission towers, cellular phones, etc.). In order to minimize the adverse effects of the interference on the apparatus in cases like this, it is recommended that the following steps be taken with the apparatus being affected and with its operating environment:

1. Place the apparatus at a distance from the source of the interference.
2. Change the direction of the apparatus.
3. Change the connection method used for the apparatus.
4. Connect the apparatus to another power outlet where the power is not shared by any other appliances.

ІНФОРМАЦІЯ ПРО ПІДТВЕРДЖЕННЯ ВІДПОВІДНОСТІ ПРОДУКТУ

Виробник:	Panasonic Connect Co., Ltd.	Панасонік Коннект Ко., Лтд.
Адреса виробника:	Fukuoka, Japan	Фукуока Японія
Країна походження:	Japan	Японія

Уповноважений Представник:	ТОВ "ПАНАСОНІК УКРАЇНА ЛТД"
Адреса Уповноваженого Представника:	вул. Васильківська, буд. 30, м. Київ, 03022, Україна

Примітки:

Термін служби виробу	7 років
----------------------	---------

Дату виготовлення можна визначити за комбінацією букв і цифр серійного номера, що розташований на маркувальній таблиці виробу.

Приклад:

X X XXXXXXXX

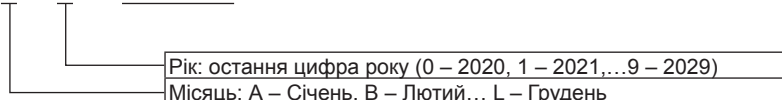

Contents

Read this first! (For AV-HS60C4P)	2
Read this first! (For AV-HS60C4E)	4
Overview	8
Overview	8
Ratings display	8
Installation	8
Accessories	8
Part Names and Functions	9
Operation panel	9
Front panel	13
Rear panel	14
Side (right)	15
Notification when the power is turned on for the first time	16
Specifications	18

How to read this document

■ Abbreviations

The following abbreviations are used in this document.

- The model numbers of the Main Frames AV-HS60U1P/AV-HS60U2P, AV-HS60U1E/AV-HS60U2E are described as “AV-HS60U1”/“AV-HS60U2”.
- The model numbers of the Control Panels AV-HS60C1P/AV-HS60C2P, AV-HS60C1E/AV-HS60C2E are described as “AV-HS60C1”/“AV-HS60C2”.
- The model numbers of the Control Panels AV-HS60C4P and AV-HS60C4E are described as “AV-HS60C4”.
- The model number of the Menu Panel AV-HS60C3G is described as “AV-HS60C3”.

Overview

Overview

AV-HS60C4 is the Control Panel with 2ME and 16 crosspoint buttons, which configures the switcher system of AV-HS6000.

This is a redundant power supply model.

For detailed operations, refer to the Operating Guide of the AV-HS6000 series.

Ratings display

The name, model number, and electrical ratings of the unit are indicated on its rear panel.

Installation

Refer to the Operating Guide of the AV-HS6000 series.

Accessories

- AC cable
 - AV-HS60C4P: 2 cables
 - AV-HS60C4E: 4 cables
- LAN cable: 1 cable (used to connect with the Main Frame AV-HS60U1/AV-HS60U2)
- Switch blank cap (large): 16 caps
- Switch blank cap (small): 8 caps

NOTE

- After removing the product from its container, dispose of the AC cable cap and packing materials in an appropriate manner.

Part Names and Functions

Operation panel

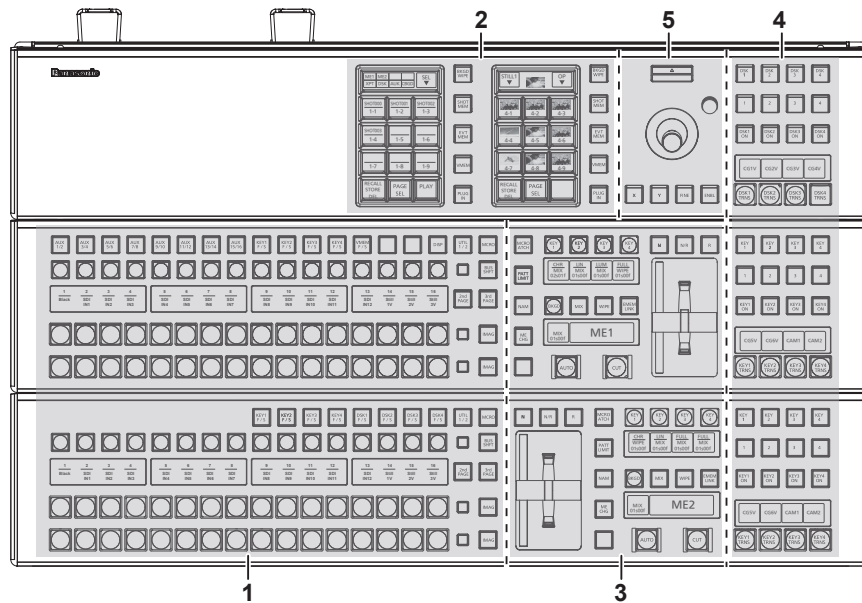

- 1 Crosspoint area
- 2 Multi-selection panel area
- 3 Transition area
- 4 KEY/DSK operation area
- 5 Positioner area

Crosspoint area

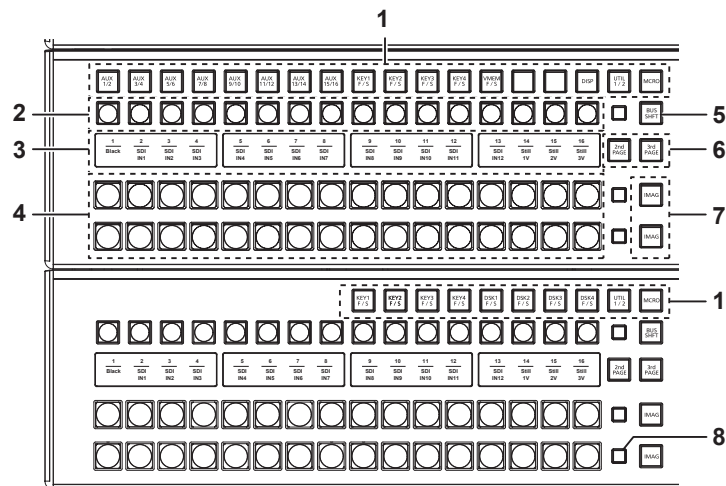

1 KEY bus selector buttons (KEY BUS DELEGATION)

Switches functions that can be operated using the KEY bus crosspoint buttons.

<p><AUX 1/2> to <AUX 15/16> buttons</p>	<p>Switches to the source selector buttons for the AUX buses.</p> <ul style="list-style-type: none"> • If you press the same buttons again while the <AUX 1/2> to <AUX 15/16> buttons are selected, the bus in the background is selected. <p>Example)</p> <p>If you press the <AUX 1/2> button again while the AUX1 bus is selected, the AUX2 bus is selected.</p> <ul style="list-style-type: none"> • The <AUX 1/2> to <AUX 3/4> buttons have the MIX transition function. • The <AUX 1/2> to <AUX 15/16> buttons have the crosspoint link coupling function.
<p><KEY1 F/S> to <KEY4 F/S> buttons</p>	<p>Switches to the source selector buttons for the key fill buses or key source buses.</p> <ul style="list-style-type: none"> • If you select key fill signal or key source signal using the KEY bus crosspoint buttons, the signals are linked and another signal is automatically selected. The unit's linking operation has two modes. The mode setting can be made from the <CONF> button on the top menu → [SOURCE LINK] → [Key Assign] tab → [Master/Slave].
<p><VMEM F/S> button</p>	<p>Switches the source selector buttons for the fill buses or source buses of [CLIP1] through [CLIP4] (video memory) and [STILL1] through [STILL4] (still image memory) input buses.</p>
<p><DISP> button</p>	<p>Switches to the source selector buttons for the DISP buses to be displayed on the Menu Panel AV-HS60C3.</p>

Part Names and Functions

<UTIL 1/2> button	Switches to the source selector buttons for the utility 1 bus/utility 2 bus that can be inserted to background wipe borders and key edges.
<MCRO> button	Switches to the start button to play back the macro memory assigned to the KEY bus crosspoint buttons. The assignment can be made from the <MEM> button on the top menu → [MACRO] → [XPT Assign] tab.
<DSK1 F/S> to <DSK4 F/S> buttons	Switches to the source selector buttons for the DSK fill buses or DSK source buses. <ul style="list-style-type: none"> If you select key fill signal or key source signal using the KEY bus crosspoint buttons, the signals are linked and another signal is automatically selected. The unit's linking operation has two modes. The mode setting can be made from the <CONF> button on the top menu → [SOURCE LINK] → [Key Assign] tab → [Master/Slave].

2 KEY bus crosspoint buttons (1 to 16)

Selects the source of the bus which was selected by the KEY bus selector buttons.

Source can be selected using the <2nd PAGE>/<3rd PAGE> button. (Maximum of 64) (page 10)

3 Source name display panels

Displays applications of the crosspoint buttons. The display settings of the source name display panels can be made from the <CONF> button on the top menu → [SOURCE NAME] → [Panel Name] tab.

When operating other than macro bus: "crosspoint number" on the upper line, "input source name" on the lower line

When operating macro bus: "macro name" on the upper line, "input source name" on the lower line

4 PGM/A bus crosspoint buttons (1 to 16), PST/B bus crosspoint buttons (1 to 16)

Selects the video signals of the PGM/A bus and PST/B bus.

Source can be selected using the <2nd PAGE>/<3rd PAGE> button. (Maximum of 64) (page 10)

- Bus mode can be selected from the <CONF> button on the top menu → [OPERATE] → [Transition] tab → [Bus Mode] column → [Bus Mode].

5 <BUS SHFT> button

Press the <AUX 1/2> to <AUX 15/16>/<KEY1 F/S> to <KEY4 F/S>/<VMEM F/S>/<UTIL 1/2>/<DSK1 F/S> to <DSK4 F/S> buttons while holding down the <BUS SHFT> button to switch the bus selection applications. For the <AUX 1/2> to <AUX 15/16> buttons, the bus selection applications can be switched even when the selected button is pressed again.

Example) <KEY1 F/S> button

When only the <KEY1 F/S> button is pressed, the KEY bus crosspoint buttons are switched to the source selector buttons of the KEY1 fill bus.

When the <KEY1 F/S> button is pressed while the <BUS SHFT> button is held down, the KEY bus crosspoint buttons are switched to the source selector buttons of the KEY1 source bus.

6 <2nd PAGE>/<3rd PAGE> buttons

Switch the page to select the source with the KEY bus crosspoint buttons, PGM/A bus crosspoint buttons, or PST/B bus crosspoint buttons.

- The pages of the buses included in the corresponding ME can be switched at once. To switch pages at individual buses, assign the <2nd PAGE>/<3rd PAGE> button to the KEY bus crosspoint buttons, PGM/A bus crosspoint buttons, and the PST/B bus crosspoint buttons.

Button status		Displayed page
<2nd PAGE> button	<3rd PAGE> button	
Off	Off	First page
Lit	Off	Second page
Off	Lit	Third page
Lit	Lit	Fourth page

7 <IMAG> button

Enables/disables image effects (paint, mono colors, mosaics, defocusing, etc.) to be added to images selected at the PGM/A bus and PST/B bus.

- The setting to enable/disable image effects to be added to images selected in the KEY bus can be made from the <ME1>/<ME2> button on the top menu → [IMAGE] → [Key1]/[Key2] tab → [Mosaic/Defocus] column.

8 Bus tally

Indicates the output status of the buses. The buses that comprise the on-air tallies will light up.

Multi-selection panel area

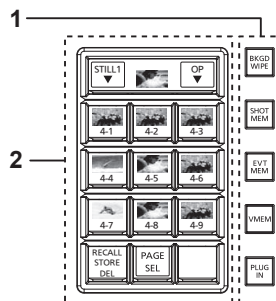

1 Mode selection button

Switches functions that can be operated on the multi-selection panel.

<BKGD WIPE> button	Selects background wipe preset.
<SHOT MEM> button	Registers/recalls/deletes register memories of the shot memory.
<EVT MEM> button	Recalls register memories of the event memory. This button is also used to select register memories during EMEM-LINK transition. <ul style="list-style-type: none"> Registration/editing are performed using the menu.

<VMEM> button	Records [CLIP1] through [CLIP4] (video memory) and [STILL1] through [STILL4] (still image memory) to the current frame memories and plays them back. <ul style="list-style-type: none"> When using the Storage Module AV-HS60D1 (optional), register memories can be registered/recalled/deleted on SSD installed in the Main Frame AV-HS60U1/AV-HS60U2.
<PLUG IN> button*	Used as a plug-in software menu.

* This is a function to be supported in the future.

2 Multi-selection menu panel

When the mode selection button is pressed, the menu to be displayed is switched.

For details, refer to “Basic operations for the multi-selection panel area” in Operating Guide (PDF).

Transition area

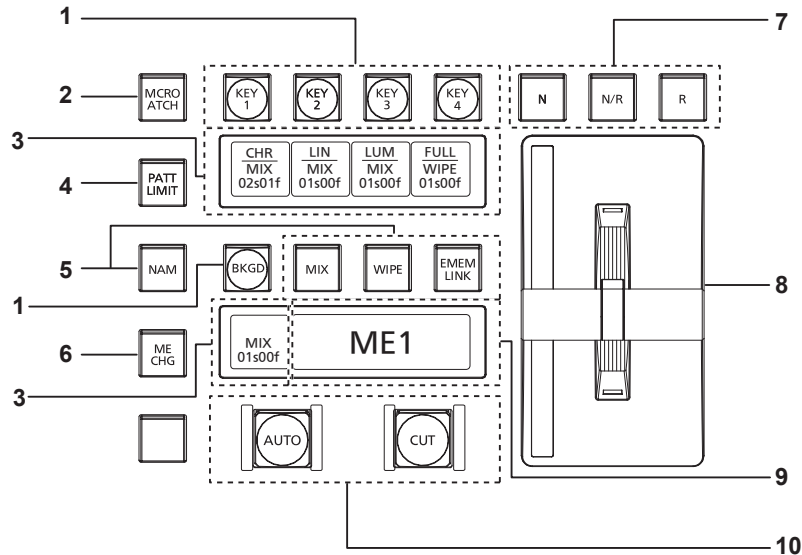

1 Transition target selection buttons (<BKGD>/<KEY1>/<KEY2>/<KEY3>/<KEY4>)

Sets the operation target for the next transition to be executed when the fader lever or <AUTO>/<CUT> button is operated.

2 <MCRO ATCH> button

Switches between enabling/disabling macro attach functions assigned to the button of the corresponding ME.

- When set to on, the macro attach function is enabled.
- The button to which the macro attach function is assigned is illuminated in a specific color while it is on. The light color setting can be made from the <SYS> button on the top menu → [CTRL PANEL] → [Button Color] tab → [Macro Attach] in the [No Sel Other] column.

3 Status display

Displays the key type (KEY only)/transition type/transition time.

4 <PATT LIMIT> button

Restricts the amount of the background wipe transition for the corresponding ME.

- When set to on, the pattern limit function is enabled.
- Set pattern limit details from the <ME1>/<ME2> button on the top menu → [BKGD] → [Position] tab → [Pattern Limit] column.

5 Transition type selection buttons (<NAM>/<MIX>/<WIPE>/<EMEM LINK>)

<MIX> button	Switches images while overlapping. During the transition, the output total of the A bus and B bus is kept at 100%. In background transition, the above operation is applied when the <NAM> button is off. It will perform non-additive mixing or color mix mixing depending on the setting of the top menu <ME1>/<ME2> button → [BKGD] → [Transition] tab → [Trans Type] column when the <NAM> button is on. For details, refer to “<NAM> button setting” in Operating Guide (PDF).
<WIPE> button	Performs transition according to the patterns set in the menu or selected at the wipe preset on the multi-selection panel area.
<EMEM LINK> button	Performs transition according to the patterns registered in the event memory.

6 <ME CHG> button

Switches the display of the multi-selection panel area to the menu for changing ME which is the operation target.

7 Wipe direction selection buttons

Selects the wipe direction when executing the background transition. The operation is not performed when the transition is a key.

<N> button	Wiping proceeds in the normal direction.
<R> button	Wiping proceeds in the reverse direction.
<N/R> button	The normal direction is replaced with the reverse direction (or vice versa) when the transition is completed. <ul style="list-style-type: none"> On/off of the <N>/<R> button is also switched according to the wipe direction.

8 Fader lever/transition status

Used to execute background or key transitions. When the lever is moved as far as it will go, the transition is completed. If the fader lever has been operated during auto transition, auto transition will be switched to manual operation as soon as the fader lever position overtakes the amount of the transition being executed.

For details on the transition status display, refer to “Transition status display” (page 12).

Part Names and Functions

9 ME status area

Displays the ME of the operations target. Use the <ME CHG> button to switch the ME of the operation target.

10 transition execution button

<AUTO> button	Automatically executes transition. (Auto transition) • To set the transition time, select the <ME1>/<ME2> button on the top menu → [BKGD] → [Transition] tab → [Transition] column → [Time].
<CUT> button	Executes transition instantly.

■ Transition status display

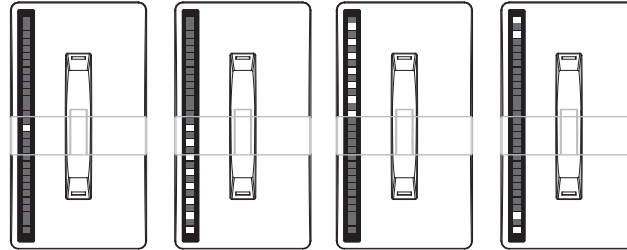

Fig. 1

Fig. 2

Fig. 3

Fig. 4

The transition status display at the left side of the fader lever indicates not the lever position but the amount of transition, and also works during auto transition.

During pattern limitation, the amount of limitation will also be displayed. (Fig. 1)

If the fader lever position and the amount of images do not match after memory playback or auto transition execution, every other display will be displayed. When displayed at one side (Fig. 2, Fig. 3), push the lever towards the displayed side to make the lever position recognize.

If multiple operations of BKGD and KEY1 to KEY4 are performed in the next transition, both sides may become unmatched. In such a case, the display will be like Fig. 4, so move the fader lever back and forth to make the lever position recognize.

KEY/DSK operation areas

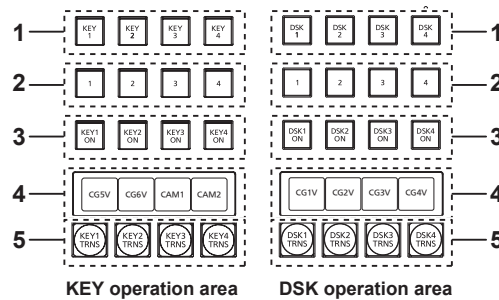

1 Operation target selection buttons (<KEY1>/<KEY2>/<KEY3>/<KEY4>/<DSK1>/<DSK2>/<DSK3>/<DSK4>)

Selects the operation target for key/DSK preset memory.
Switches target to be displayed in the SEL KEYPVW output.

2 Key/DSK preset memory buttons (<1>/<2>/<3>/<4>)

Recalls/stores the key preset memory.

- Short press: Recalls data saved to the corresponding button. (Recall)
- Long press: Stores the current key settings to the corresponding button. (Store)

Current key setting can be deleted (Delete) by press and holding. For details, refer to “Key preset” in Operating Guide (PDF).

3 <KEY1 ON>/<KEY2 ON>/<KEY3 ON>/<KEY4 ON>/<DSK1 ON>/<DSK2 ON>/<DSK3 ON>/<DSK4 ON> buttons

Executes/cancels each key with a cut transition.

4 Source name display panels

Displays the source name selected for each key.

5 <KEY1 TRNS>/<KEY2 TRNS>/<KEY3 TRNS>/<KEY4 TRNS>/<DSK1 TRNS>/<DSK2 TRNS>/<DSK3 TRNS>/<DSK4 TRNS> buttons

Executes transition with the transition type and transition time for each key set in the menu.

Positioner area

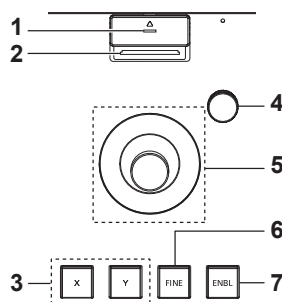

1 Memory card access LED

Lights up while accessing the memory card.

Do not turn off the power of the unit or eject the memory card while lit. The memory card or data in the memory card may be damaged.

2 Memory card slot

Insert an SD memory card (optional) or an SDHC memory card (optional).

3 Positioner buttons (<X>/<Y>)

<X> button	Enables/disables the X-axis operation of the positioner (horizontal direction). When set to on, operation is enabled.
<Y> button	Enables/disables the Y-axis operation of the positioner (vertical direction).

4 Z-axis dial

Used to set the numeric values at the numeric entry items on the Menu Panel AV-HS60C3.

It corresponds to the third from the left of the rotary encoders on the Menu Panel AV-HS60C3.

5 Positioner

Used to set the numeric values at the numeric entry items on the Menu Panel AV-HS60C3.

- X axis (horizontal direction): Corresponds to the leftmost of the rotary encoders on the Menu Panel AV-HS60C3.

- Y axis (vertical direction): Corresponds to the second from the left of the rotary encoders on the Menu Panel AV-HS60C3.

6 <FINE> button

Changes the amount of change in parameter for the positioner operation.

When set to on, finer adjustments can be made.

7 <ENBL> button

Lit: Enables operations of the positioner and Z-axis dial.

Off: Disables operations of the positioner and Z-axis dial.

**NOTE**

- This unit detects the position of the positioner and sets the position to the center by the time when the startup is completed after power is turned on. Do not touch the positioner until the startup of the unit is completed.

Memory cards

Memory cards used with the unit should conform to SD or SDHC standards.

Be sure to format memory cards using the unit.

Memory cards with the following capacity can be used for the unit. The unit does not support SDXC memory cards.

SD memory card: 8 MB to 2 GB

SDHC memory card: 4 GB to 32 GB

For the latest information not available in the Operating Guide, visit the following website.

<https://pro-av.panasonic.net/> (English only)

- Keep the following points in mind when using or storing memory cards.

- Avoid high temperatures/humidities.
- Do not expose to water droplets.
- Avoid electrical charges.

Front panel

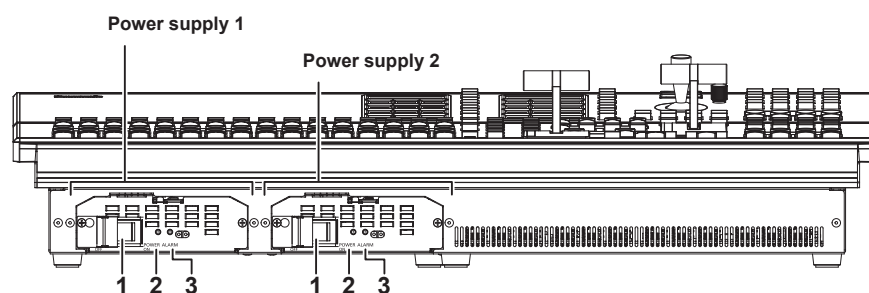
**1 <POWER> switch (with safety guard)**

Turns power on/off.

- When turning off the power, set both the <POWER> switch for the power supply 1 and the <POWER> switch 2 for the power supply 2 to <OFF>.

2 Power indicator

When power is input into the <AC IN 1>/<AC IN 2> terminal, both <POWER> switches of the power supply 1 and the power supply 2 will light up when they are set to <ON>.

3 Alarm indicator <ALARM>

Lights up when there is a problem (voltage decrease) in the power supply of the Control Panel AV-HS60C4. At this time, an alarm message is displayed on the Menu Panel AV-HS60C3.

An alarm will be displayed if both <POWER> switches of the power supply 1 and the power supply 2 have not turned on.

When an alarm has occurred, details of the problem can be checked from the <SYS> button on the top menu → [MAINTENANCE] → [Alarm] tab.

The alarm status can be output from the <GPI I/O> terminal of the Control Panel AV-HS60C4 to external devices.

**NOTE**

- When an alarm has occurred, stop using the unit immediately, and be sure to contact your dealer. Continuous use of the unit even after an alarm has occurred could damage the unit.

Rear panel

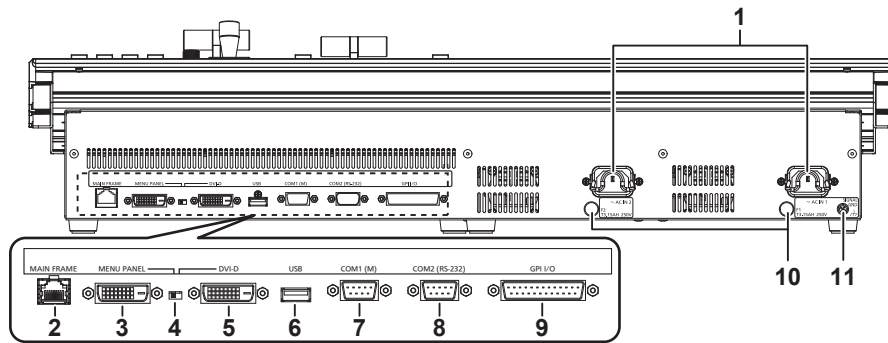
**1 <AC IN 1>/<AC IN 2> terminals (signal: AC)**

Connects one end of the supplied AC cable to this terminal and the other end to the AC outlet. (AC 100 V to 240 V, 50 Hz/60 Hz)

- The supplied AC cable has a 3-pin plug with a grounding terminal. Connect to a 3-pin power outlet which is equipped with a grounding terminal.
- If a 3-point power outlet is not available, be sure to consult your dealer.

2 <MAIN FRAME> terminal (connector: RJ-45/signal: 100Base-TX)

Connects to the <PANEL> terminal or <LAN> terminal of the Main Frame AV-HS60U1/AV-HS60U2.

- When connected to the <LAN> terminal, no video will be displayed on the Menu Panel AV-HS60C3.

3 <MENU PANEL> terminal (connector: DVI-D/signal: independent signal)

Connects the Menu Panel AV-HS60C3.

- Cannot be used concurrently with a DVI monitor (computer) connected to the <DVI-D> terminal. Select with the display selector switch.
- This is the dedicated interface for the Menu Panel AV-HS60C3. Do not connect with DVI output devices.

4 Display selector switch

Switches the terminal to be used to the <MENU PANEL> terminal or <DVI-D> terminal depending on the connected device.

Switch this when the power is off. Output will not be performed properly if switched with the power turned on. Restarting of the unit will be necessary. Set the power to <OFF>, and then set it back to <ON>.

5 <DVI-D> terminal (connector: DVI-D/signal: DVI OUT)

Connects the DVI monitor (computer) used for the menu display.

- Monitor resolution: 1366×768 compatible monitor
- Cannot be used concurrently with the <MENU PANEL> terminal. Select with the display selector switch.

6 <USB> terminal (connector: USB (type A, female)/signal: USB)

Used for the menu operation of the DVI monitor (computer).

- Cannot be used for the Menu Panel AV-HS60C3.

7 <COM1 (M)> terminal (connector: D-sub 9-pin (female), inch screw/signal: RS-422)

Used for master connection of external devices.

8 <COM2 (RS-232)> terminal (connector: D-sub 9-pin (male), inch screw/signal: RS-232)

Used to control external device.

9 <GPI I/O> terminal (connector: D-sub 25-pin (female), inch screw/signal: GPI)

Equipped with 8 contact input ports (GPI IN) that control the unit externally, 10 output ports (GPI OUT) that output tallies or status information from the unit, and an alarm output port (ALARM OUT).

10 <F1>/<F2> terminals

(Fuse)

11 <SIGNAL GND> terminal (signal: SG)

Connects to the ground of the system.

NOTE

- For the cable connecting to the <DVI-D> terminal, use a double-shielded cable.
- For the cable connecting to the <MAIN FRAME> terminal, <COM1 (M)>/<COM2 (RS-232)> terminal, and <GPI I/O> terminal, use a shielded cable.
- The <COM1 (M)> terminal and the <COM2 (RS-232)> terminal cannot be used with the sub control panel.

Side (right)

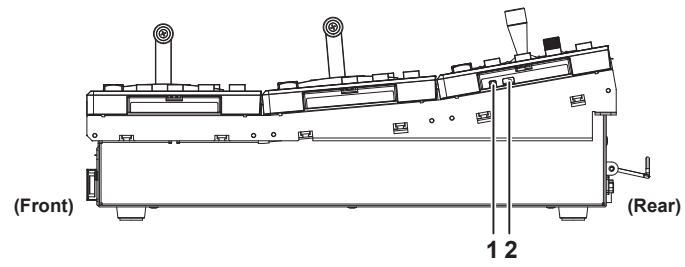

- 1 Reset switch**
The reset switch for the Control Panel. (For maintenance)
- 2 Service switch**
The switch for maintenance. Normally use it by setting to forward.

Notification when the power is turned on for the first time

When using the products for the first time, connect the Control Panel AV-HS60C1/AV-HS60C2/AV-HS60C4 to the <PANEL> terminal of the Main Frame AV-HS60U1/AV-HS60U2, and then turn on the power.

Depending on the combination of the purchased Main Frame and the Control Panel, the version of the firmware for each may not match.

When the version of the firmware for the Main Frame and the Control Panel does not match, the Control Panel will not correctly boot when the power is turned on.

Boot status when the versions do not match

Two buttons out of PST/B bus crosspoint buttons in the ME line in front will blink. One button will blink in green, and the other will blink in red. (Fig. 1)

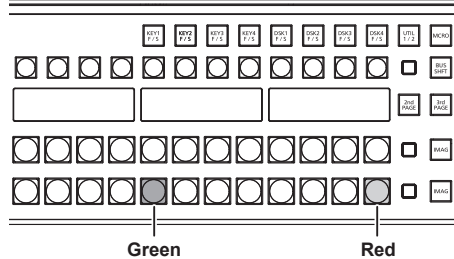

Fig. 1

- When it goes into this status, it is necessary to match the firmware version of the Control Panel to the Main Frame.
- If it does not go into this status and the Control Panel boots normally, the firmware versions of the Main Frame and the Control Panel do match.
- Check the latest software information and perform the version update of the software if necessary. For details, refer to “To perform the version update of the software” (page 16).

To match the firmware version of the Control Panel to the Main Frame

The firmware of the Control Panel is updated when the following operation is performed. Once the update is correctly performed, the firmware version of the Control Panel will match with the firmware version of the Main Frame, and it will boot in normal status.

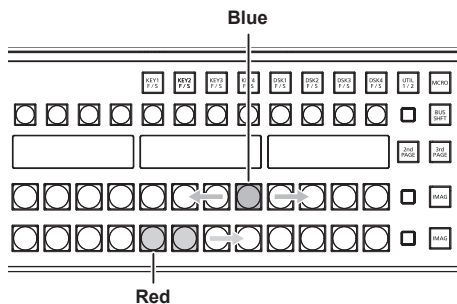

Fig. 2

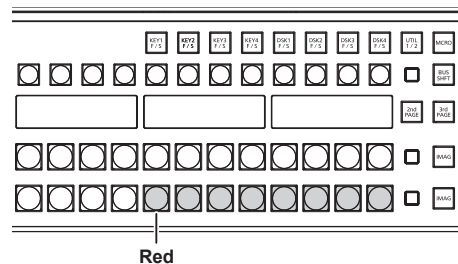

Fig. 3

1 Press the button blinking in red (Fig. 1).

Update of the firmware is started.

- Status when the firmware of the Control Panel is being updated (Fig. 2)

- Eight buttons out of the PGM/A bus crosspoint buttons in the ME line in front will repeatedly blink in blue from left to right.
- Eight buttons out of the PST/B bus crosspoint buttons in the ME line in front will blink in red sequentially from left to right.

Update of the firmware will complete after approximately two minutes.

- Status when the update of the firmware of the Control Panel is completed

- Eight buttons out of the PST/B bus crosspoint buttons in the ME in front will continue to blink in red. (Fig. 3)
- Depending on the version of the firmware of the Main Frame, the Control Panel may automatically reboot. The firmware of the Control Panel is updated correctly for this too.

2 Turn off the power of the Main Frame and the Control Panel.

- Turn off the power after completing the update of the firmware of the Control Panel.
- Do not turn off the power of the Main Frame and the Control Panel while the firmware of the Control Panel is still updating (Fig. 2).

3 Turn on the power of the Main Frame and the Control Panel.

Control Panel is booted and the menu screen is displayed in the menu panel when the firmware is correctly updated.

4 Select the <SYS> button → [MAINTENANCE] → [Boot] tab → [Initial] column → [Initial] button.

5 Select [OK] in the confirmation screen.

The AV-HS6000 is initialized.

Go on to the procedure in “To perform the version update of the software” (page 16).

To perform the version update of the software

Check the latest software information and perform the version update of the software if necessary.

1 Check the <SYS> button → [MAINTENANCE] → [Status] tab → [System Version] column → [System Version].

2 Perform the version update of the software if necessary.

Check the latest software information in the following website, and perform the software version update if necessary.

<https://pro-av.panasonic.net/> (English only)

- The Control Panel AV-HS60C4 operates normally only when the version of the software is 3.10-00-0.00 or later.

Be sure to perform the version update if the version of the software checked in step **1** is earlier than 3.10-00-0.00.

Specifications

Specifications

Power supply
AC ~ 100 V to 240 V, 50 Hz/60 Hz
Power consumption
40 W

Supports redundant power supply.

indicates safety information.

Control terminal

<MAIN FRAME> terminal	Compatible with 100Base-TX and AUTO-MDIX (For Main Frame AV-HS60U1/AV-HS60U2 connection) <ul style="list-style-type: none">• Connection cable (supplied with AV-HS60C4): LAN cable (CAT5E), straight cable, STP (Shielded Twisted Pair), 10 m (32.8 ft)• Connector: RJ-45 * When connected to the <LAN> terminal, no video will be displayed on the Menu Panel AV-HS60C3.
<MENU PANEL> terminal	Used only for the Menu Panel AV-HS60C3 <ul style="list-style-type: none">• Connector: DVI-D• Cannot be displayed on a DVI-D monitor because an independent signal format is used.• Cannot be used concurrently with a DVI-D monitor (computer) connected to the <DVI-D> terminal. Select with the display selector switch.
<DVI-D> terminal	Used for displaying menus to the DVI monitor (computer) <ul style="list-style-type: none">• Connector: DVI-D• Monitor resolution: 1366×768 compatible monitor• Cannot be used concurrently with the <MENU PANEL> terminal. Select with the display selector switch.
<USB> terminal	For DVI monitor (computer) menu operation <ul style="list-style-type: none">• Connector: USB (Type A, female)• Cannot be used for the Menu Panel AV-HS60C3.
Display selector switch	Switch for selecting <MENU PANEL> terminal or <DVI-D> terminal
<COM1 (M)> terminal	RS-422 control terminal For master connection for controlling external devices <ul style="list-style-type: none">• Connector: D-sub 9-pin (female), inch screw
<COM2 (RS-232)> terminal	RS-232 control terminal For external device control connections <ul style="list-style-type: none">• Connector: D-sub 9-pin (male), inch screw
<GPI I/O> terminal	GPI IN: 8 inputs, general-purpose, photocoupler sensing ALARM OUT: 1 output, open collector output (negative logic) GPI OUT: 10 outputs, selected from general purpose, tally Open collector output <ul style="list-style-type: none">• Connector: D-sub 25-pin (female), inch screw• Logic is switchable by menu.
ME number	2ME

Other

Ambient operating temperature	0 °C to 40 °C (32 °F to 104 °F)
Humidity	10% to 90% (no condensation)
Dimensions (W×H×D)	656 mm×160 mm×400 mm (25-27/32 inches×6-5/16 inches×15-3/4 inches) (excluding protrusions)
Mass	Approx. 15.0 kg (33.1 lbs.) (excluding accessories)

■ For AV-HS60C4

Inrush current, measured according to European standard EN55103-1, on initial switch-on: 3 A, after a supply interruption of 5 s: 25 A (Each mains input)



Disposal of Old Equipment

Only for European Union and countries with recycling systems

This symbol on the products, packaging, and/or accompanying documents means that used electrical and electronic products must not be mixed with general household waste.

For proper treatment, recovery and recycling of old products, please take them to applicable collection points in accordance with your national legislation.

By disposing of them correctly, you will help to save valuable resources and prevent any potential negative effects on human health and the environment.

For more information about collection and recycling, please contact your local municipality, dealer or supplier.

Penalties may be applicable for incorrect disposal of this waste, in accordance with national legislation.