

datavideo

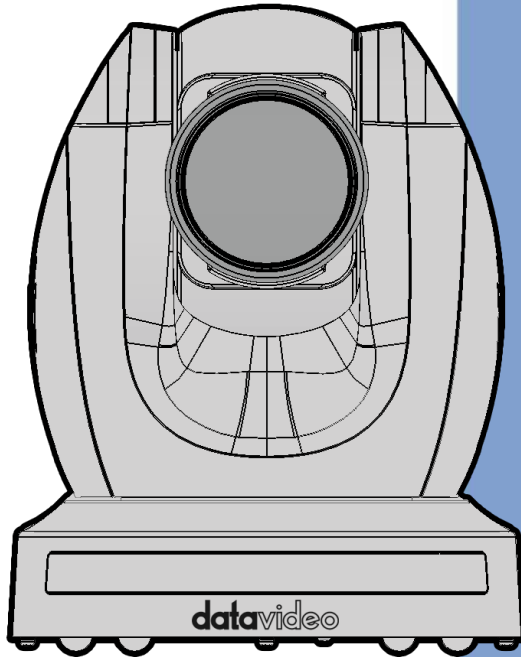

4K NDI TRACKING PTZ CAMERA

PTC-285NDI

Instruction Manual

www.datavideo.com

Table of Contents

TABLE OF CONTENTS	2
FCC COMPLIANCE STATEMENT	5
WARNINGS AND PRECAUTIONS	5
WARRANTY	7
STANDARD WARRANTY	7
THREE YEAR WARRANTY	7
DISPOSAL	8
1. PRODUCT OVERVIEW	9
FEATURES	9
2. LOCATION AND FUNCTION OF PARTS	10
3. BASIC SETUP	14
3.1 POWER-ON INITIALIZATION	14
3.2 VIDEO OUTPUT	14
HDMI Video OUT	16
3G-SDI Video Output	16
4. HOW TO USE THE NDI STUDIO MONITOR SOFTWARE	17
4.1 NDI INTRODUCTION	17
4.2. HOW TO USE THE NDI STUDIO MONITOR SOFTWARE (TAKE WINDOWS FOR EXAMPLE) (TAKE NDI TOOLS FOR WINDOWS V.5.0.5.0 FOR EXAMPLE)	17
5. REMOTE CONTROL AND ON-SCREEN MENU	22
5.1 REMOTE CONTROL FUNCTIONS	22
5.2 OSD MENU	26
5.3 PROFESSIONAL JARGON EXPLANATIONS OF THE OSD MENU	37
6. INSTRUCTION FOR INSTALLATION	39
7. NETWORK CONNECTION	45
7.1 DHCP MODE	46
7.2 STATIC IP	48
7.3 DVIP	49
8. HOW TO USE PTC-285NDI'S AI AUTO TRACKING	52

8.1	HOW TO TURN ON THE AI AUTO-TRACKING FUNCTION BY THE REMOTE CONTROLLER	52
8.2	HOW TO TURN OFF THE AI AUTO-TRACKING FUNCTION BY THE REMOTE CONTROLLER	52
8.3	HOW TO SET THE AI AUTO-TRACKING FUNCTION BY THE OSD MENU	53
8.4	HOW TO SET THE AI AUTO-TRACKING (PRESENTER MODE) BY THE WEB UI	53
8.5	HOW TO SET THE AI AUTO-TRACKING BY THE WEB UI (ZONE MODE)	54
9.	WEB USER INTERFACE	58
9.1	LIVE	58
9.2	VIDEO	59
9.2.1	How to Connect the PTC-285NDI to a Datavideo Switcher after a 60FPS/50FPS Video Streaming (Take the HS-1300 as an example)	63
9.3	AT(AUTO-TRACKING)	66
9.4	IMAGE	68
9.5	AUDIO	69
9.6	SYSTEM	71
9.7	NETWORK	73
9.8	NDI® CONFIG	84
9.9	INFORMATION	85
9.10	THE PTZ CONTROL AREA OF THE WEB UI	87
10.	HOW TO USE THE WEB UI TO SET AND CALL PRESETS	90
11.	QUICK SETTING AREA FOR THE AUTO-TRACKING	91
12.	CONTROL THE CAMERA BY THE PTZ VIEW ASSIST APP	92
13.	DIP SWITCH SETTINGS	93
13.1	DIP SWITCH SW1	93
13.2	DIP SWITCH SW2 (IRID)	94
14.	HOW TO PLAY THE RTSP STREAM BY THE VLC PLAYER	95
15.	HOW TO PLAY THE MULTICAST BY THE VCL PLAYER	97
16.	HOW TO STREAM TO FACEBOOK	98
17.	HOW TO STREAM TO YOUTUBE	109
18.	HOW TO DO THE SRT STREAMING BY THE VMIX SOFTWARE	113
19.	REMOTE CONTROL PORT PINOUTS	126
20.	FIRMWARE UPDATE	128

20.1 FIRMWARE UPDATE BY THE PTC-285NDI FIRMWARE UPDATE TOOL.....	128
20.2 FIRMWARE UPDATE BY THE USB FLASH DRIVE	132
21. FREQUENTLY-ASKED QUESTIONS.....	135
22. DIMENSIONS.....	137
23. SPECIFICATIONS.....	138
SERVICE AND SUPPORT	144

Disclaimer of Product and Services

The information offered in this instruction manual is intended as a guide only. At all times, Datavideo Technologies will try to give correct, complete and suitable information. However, Datavideo Technologies cannot exclude that some information in this manual, from time to time, may not be correct or may be incomplete. This manual may contain typing errors, omissions or incorrect information. Datavideo Technologies always recommend that you double check the information in this document for accuracy before making any purchase decision or using the product. Datavideo Technologies is not responsible for any omissions or errors, or for any subsequent loss or damage caused by using the information contained within this manual. Further advice on the content of this manual or on the product can be obtained by contacting your local Datavideo Office or dealer.

FCC Compliance Statement

This device complies with part 15 of the FCC rules. Operation is subject to the following two conditions:

- (1) This device may not cause harmful interference, and
- (2) This device must accept any interference received, including interference that may cause undesired operation.

Warnings and Precautions

1. Read all of these warnings and save them for later reference.
2. Follow all warnings and instructions marked on this unit.
3. Unplug this unit from the wall outlet before cleaning. Do not use liquid or aerosol cleaners. Use a damp cloth for cleaning.
4. Do not use this unit in or near water.
5. Do not place this unit on an unstable cart, stand, or table. The unit may fall, causing serious damage.
6. Slots and openings on the cabinet top, back, and bottom are provided for ventilation. To ensure safe and reliable operation of this unit, and to protect it from overheating, do not block or cover these openings. Do not place this unit on a bed, sofa, rug, or similar surface, as the ventilation openings on the bottom of the cabinet will be blocked. This unit should never be placed near or over a heat register or radiator. This unit should not be placed in a built-in installation unless proper ventilation is provided.
7. This product should only be operated from the type of power source indicated on the marking label of the AC adapter. If you are not sure of the type of power available, consult your Datavideo dealer or your local power company.
8. Do not allow anything to rest on the power cord. Do not locate this unit where the power cord will be walked on, rolled over, or otherwise stressed.

9. If an extension cord must be used with this unit, make sure that the total of the ampere ratings on the products plugged into the extension cord do not exceed the extension cord's rating.
10. Make sure that the total amperes of all the units that are plugged into a single wall outlet do not exceed 15 amperes.
11. Never push objects of any kind into this unit through the cabinet ventilation slots, as they may touch dangerous voltage points or short out parts that could result in risk of fire or electric shock. Never spill liquid of any kind onto or into this unit.
12. Except as specifically explained elsewhere in this manual, do not attempt to service this product yourself. Opening or removing covers that are marked "Do Not Remove" may expose you to dangerous voltage points or other risks, and will void your warranty. Refer all service issues to qualified service personnel.
13. Unplug this product from the wall outlet and refer to qualified service personnel under the following conditions:
 - a. When the power cord is damaged or frayed;
 - b. When liquid has spilled into the unit;
 - c. When the product has been exposed to rain or water;
 - d. When the product does not operate normally under normal operating conditions. Adjust only those controls that are covered by the operating instructions in this manual; improper adjustment of other controls may result in damage to the unit and may often require extensive work by a qualified technician to restore the unit to normal operation;
 - e. When the product has been dropped or the cabinet has been damaged;
 - f. When the product exhibits a distinct change in performance, indicating a need for service.

Warranty

Standard Warranty

- Datavideo equipment are guaranteed against any manufacturing defects for one year from the date of purchase.
- The original purchase invoice or other documentary evidence should be supplied at the time of any request for repair under warranty.
- The product warranty period begins on the purchase date. If the purchase date is unknown, the product warranty period begins on the thirtieth day after shipment from a Datavideo office.
- All non-Datavideo manufactured products (product without Datavideo logo) have only one year warranty from the date of purchase.
- Damage caused by accident, misuse, unauthorized repairs, sand, grit or water is not covered under warranty.
- Viruses and malware infections on the computer systems are not covered under warranty.
- Any errors that are caused by unauthorized third-party software installations, which are not required by our computer systems, are not covered under warranty.
- All mail or transportation costs including insurance are at the expense of the owner.
- All other claims of any nature are not covered.
- All accessories including headphones, cables, and batteries are not covered under warranty.
- Warranty only valid in the country or region of purchase.
- Your statutory rights are not affected.

Three Year Warranty

- All Datavideo products purchased after July 1st, 2017 are qualified for a free two years extension to the standard warranty, providing the product is registered with Datavideo within 30 days of purchase.



- Certain parts with limited lifetime expectancy such as LCD panels, DVD drives, Hard Drive, Solid State Drive, SD Card, USB Thumb Drive, Lighting, Camera module, PCIe Card are covered for 1 year.
- The three-year warranty must be registered on Datavideo's official website or with your local Datavideo office or one of its authorized distributors within 30 days of purchase.

Disposal



For EU Customers only - WEEE Marking

This symbol on the product or on its packaging indicates that this product must not be disposed of with your other household waste. Instead, it is your responsibility to dispose of your waste equipment by handing it over to a designated collection point for the recycling of waste electrical and electronic equipment. The separate collection and recycling of your waste equipment at the time of disposal will help to conserve natural resources and ensure that it is recycled in a manner that protects human health and the environment. For more information about where you can drop off your waste equipment for recycling, please contact your local city office, your household waste disposal service or the shop where you purchased the product.

1. Product Overview

The PTC-285NDI series features a large 1/2.8" CMOS sensor, supports high-quality 2160p50/60 UHD video output, features 12x optical zoom, 16x digital zooms and supports versatile outputs, including 3G-SDI, HDMI, IP stream and NDI. The PTC-285NDI series will be the ideal choice for taking your remote camera production to the next level.

Features

- 2160p50/59.94/60 PTZ camera
- 12x Optical Zoom, 16x Digital Zoom
- 4K Video interfaces: HDMI, H.264/H.265
- 2160p and 1080p (3G-SDI) Simultaneous video output
- RS-422 Serial Port Control
- External audio input: 3.5mm audio in/line in (switchable on the web UI)
- Friendly web UI
- White color model available.

2. Location and Function of Parts

Front of Camera	
	
1	Lens Built-in 1/2.8" 8.51M Pixel CMOS 4K color camera with white balance control, backlight compensation, automatic gain and etc.
2	Tally LED Tally lamp will be turned ON upon receiving the ON signal.
3	Sensor for Remote Control Remote control IR receiver

Rear of Camera

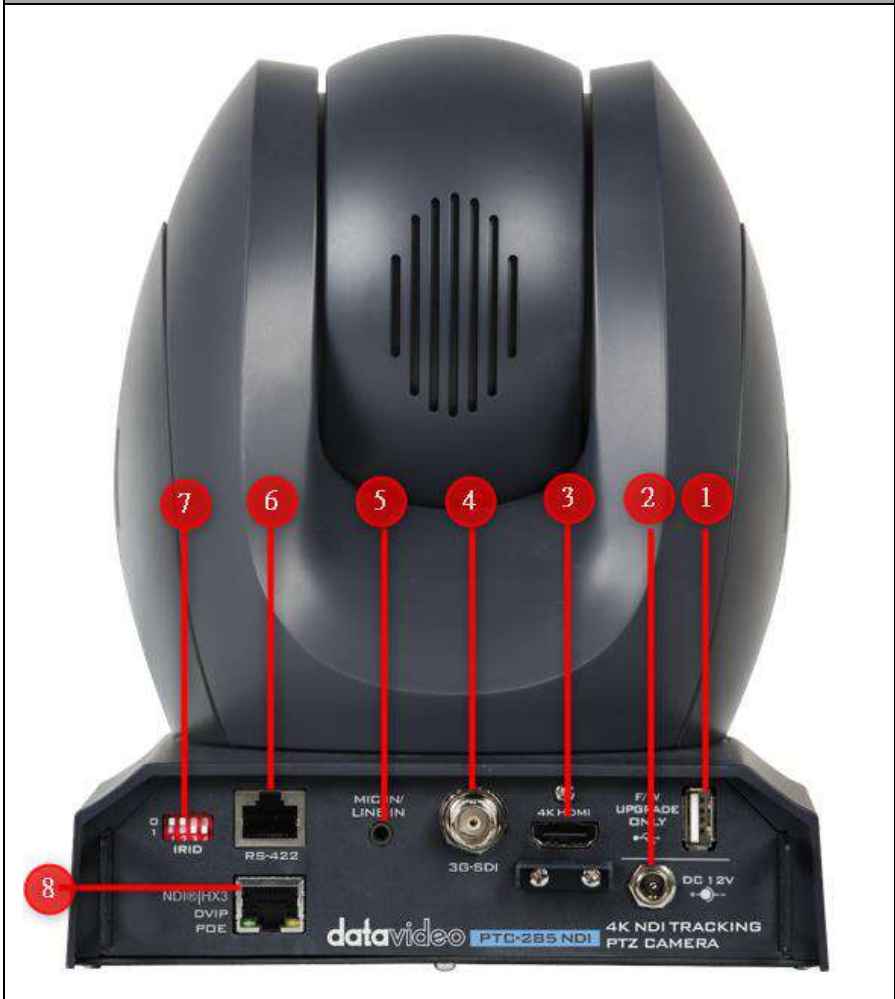

1	<p>USB Port</p> <p>This USB port is used for updating firmware. Users can save the latest version of firmware in a USB flash drive and then insert it into this interface for firmware updating.</p> <p>Note: After inserting the USB flash drive, please remember to turn “ON” the SETUP->USB UPGRADE from the OSD menu of the PTC-285NDI camera.</p>
2	<p>Power Input</p> <p>DC in socket connects the supplied 12V PSU. The connection can be secured by screwing the outer fastening ring of the DC In plug to the</p>

	socket.
3	4K HDMI OUT The 4K HDMI OUT allows you to connect an external HDMI monitor via an HDMI cable.
4	3G-SDI OUT The 3G-SDI OUT allows you to connect an external monitor via an SDI cable.
5	MIC IN/LINE IN The 3.5mm audio input receives external audio.
6	RS-422 Interface (RJ-45) The RS-422 interface serves to connect external RS-422 devices. Use an Ethernet cable to connect external RS-422 controllers. See “Section 19 Remote Control Port Pinouts” for making the cable for the RS-422 interface.
7	IRID Interface This interface allows users to use the DVIP Switch to control the numbering of the camera on the remote controller. Users can use this interface to set the camera to any number from No.1 to No. 4 in order to use remote controller to control the camera.
8	DVIP/POE/NDI® HX3 Interface The DVIP interface allows users to control the PTC-285NDI camera by Datavideo’s camera controller by using the DVIP Protocol which is developed by Datavideo. Moreover, this interface can support the PoE (Power over Ethernet) technology. Moreover, this interface also support NDI protocol.

Bottom of Camera

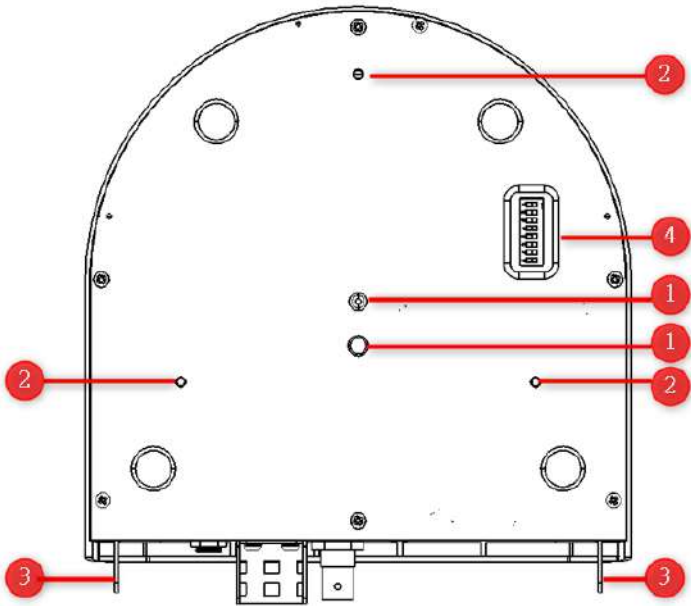

1	Tripod Screw Hole allows the user to mount the camera on the tripod.
2	Screw Hole Screw holes for ceiling bracket mounting.
3	For Safety Rope Ties safety rope for fixing the camera to the ceiling.
4	DIP Switch This DIP Switch allows users to adjust needed parameters such as VISCA ID, resolutions, remote control protocol and video modes.

3. Basic Setup

3.1 Power-On Initialization

As shown in the diagram below, after you plug in the power cord, the tally light in the front will start flashing red and will be OFF as soon as the power-on initialization is complete. The camera head should be at the HOME position with the lens facing front. If the power is inserted, the camera lens will go back to the position where the camera power is off last time. Note: After powering-on, you need to wait for about 45 seconds, and then the image which is shot by the PTC-285NDI will be shown on the connected monitor.



Connect the DC 12 V power

3.2 Video Output

You are allowed to view the camera video via **NDI® | HX3/DVIP/POE, 4K HDMI OUT** and **3G-SDI OUT**.

NDI® | HX3/DVIP/POE Port



Please follow following steps for viewing the camera video from the web UI.

- **Connect the PTC-285NDI camera directly to your PC/Notebook PC**

1. Connect the PTC-285NDI to your PC or laptop by an Ethernet Cable.
2. Open the web UI by the connected PC or laptop and then please enter the default IP address into the address bar of the web browser.

Note: The default static IP address of the PTC-285NDI is 192.168.100.100.

3. The login page of the web UI will be opened, please enter the user name and password (the default user name and password are admin/admin).
4. Open the preview window for previewing the video which is shot by the camera.

- **Connect the PTC-285NDI camera to your PC or laptop by a router.**

1. Please set the Ethernet IP address of your PC or laptop as 192.168.100.x(x means 0-255) and it will be at the same local area network as the PTC-285NDI.

2. Please use an RJ-45 Ethernet cable to connect from the NDI® | HX3/DVIP/POE port on the rear panel of the PTC-285NDI to the LAN port of a router. And then please use another RJ-45 Ethernet cable to connect from the RJ-45 Ethernet port of your PC or laptop to the LAN port of the same router.

3. Please open the web UI from the connected PC or laptop and then please enter the default IP address of the camera into the address bar of the web browser.

Note: The default static IP address of the PTC-285NDI is 192.168.100.100.

4. The login page of the web UI will be opened, please enter the user name and password (the default user name and password are admin/admin).
5. Click into the preview window on which the video will be displayed.

HDMI Video OUT

Connect the 4K HDMI OUT to an external connected monitor using an HDMI cable.



3G-SDI Video Output

Connect the SDI OUT to an external connected monitor using an SDI cable.



4. How to Use the NDI Studio Monitor Software

4.1 NDI Introduction



NDI is an Ethernet-based open video and audio transmission standard. NDI allows bilateral video and audio signal transmission for devices which are located within the same Local Area Network. It provides low-latency and real-time features which make it an ideal solution for the live production application.

4.2. How to Use the NDI Studio Monitor Software (Take Windows for example) (Take NDI Tools for Windows v.5.0.5.0 for example)

Please follow following steps for using the NDI Studio Monitor software.

1. At first, please make sure that your PTC-285NDI camera and your laptop are connected to a router and they are set in the same LAN.

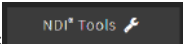
2. Please go to NewTek official website <https://www.ndi.tv/>. After that, please

click NDI Tools  and then click “Download”  from “NDI Tools for Windows” to download the latest version NDI Tools software.

3. After the installation is finished, please click “Studio Monitor” to open the NDI Studio Monitor software.



You can also click “NDI”  to open the “NDI Launcher” which is shown in the following diagram. After that, please click the “Studio Monitor” from the NDI Launcher panel to enter the Studio Monitor interface.

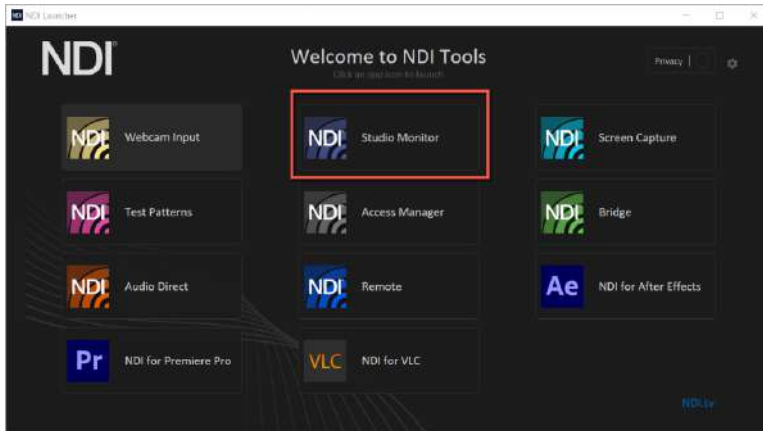

4. After the Studio Monitor Software is opened, the interface will be shown in the following diagram.

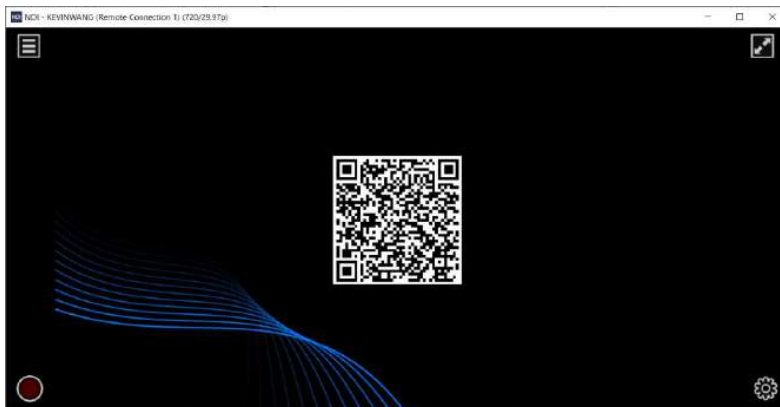

5. Please move your mouse to the up-left corner and then press the Menu button, and then you can see the menu of the Studio Monitor software. You can also right-click your mouse on the NDI Studio interface to show the menu.

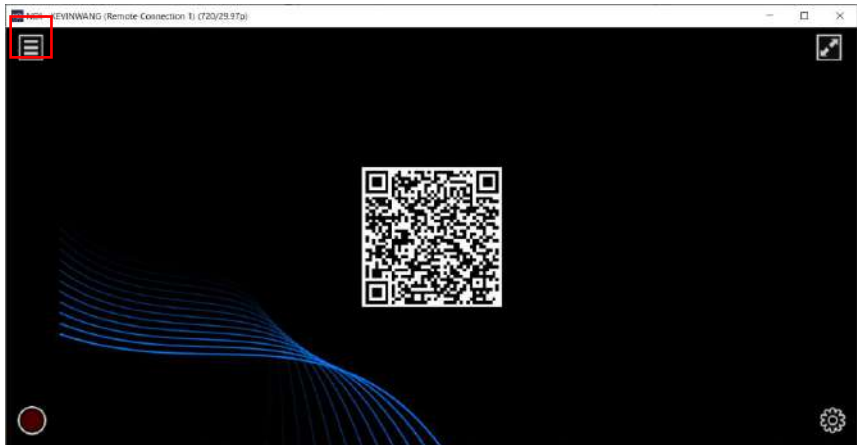

6. In the menu, you can see that the PTC-285NDI camera which is connected in the same LAN is detected by the Studio Monitor software. Please click it and then you can see the screen which is shot by the PTC-285NDI camera in the following diagram.

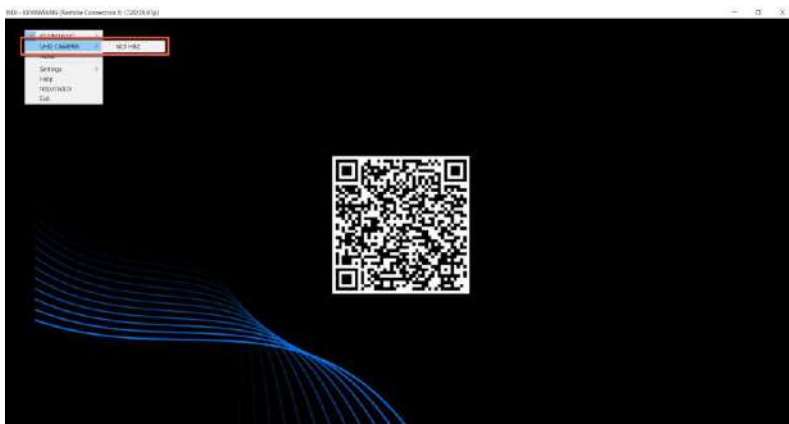



7. Please select “Settings->PTZ Settings->Show PTZ Controls” from the menu. After that, the PTZ control interface will be shown in the NDI Studio Monitor interface for users to control various functions including panning and tilting of the camera lens, Auto Focus, Zooming in/Zooming Out of the camera lens and the preset saving and recalling.









Note: If you have any problems when installing or using the NDI Studio Monitor software, please refer to NewTek NDI website <https://www.ndi.tv/> or please contact NewTek NDI Technical Support Team.





5. Remote Control and On-Screen Menu

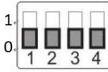



The chapter 5 provides an overview of remote control functions and OSD menu.

5.1 Remote Control Functions



No	Function Keys	Descriptions
1	<p style="text-align: center;">Power Button</p> 	<p>Power Button Press this button once to enter Standby Mode, press it again to enter Normal Mode. Note: The power consumption in Standby Mode is approximately half of the power consumption in Normal Mode.</p>
2	<p style="text-align: center;">Camera 1-4</p> 	<p>Camera 1-4 The Camera 1 to Camera 4 buttons allow you to press the corresponding number in order for further operation after the IRID number of the camera is set by the IRID DIP Switch</p>  <p>which is located on the rear panel of your PTC-285NDI camera.</p> <ul style="list-style-type: none"> ● If the DIP Switch 1 & 2 are set as (0,0), the camera IRID number will be 1. ● If the DIP Switch 1 & 2 are set as (1,0), the camera IRID number will be 2. ● If the DIP Switch 1 & 2 are set as (0,1), the camera IRID number will be 3. ● If the DIP Switch 1 & 2 are set as (1,1), the camera IRID number will be 4. <p>Note: In normal situation, the DIP Switch 3 & 4 must be “OFF” (set at 0).</p>
PT	<p style="text-align: center;">Preset1-4 Buttons</p> 	<p>The Preset buttons 1, 2, 3, and 4 allow you to set up to 4 camera preset settings.</p> <p>How to set the Preset: Please adjust your desired camera parameters and camera lens position in advance. After that, please press the “STR” button which is located on the remote controller. And then please press your desired Preset Number button (Preset 1 to Preset 4) to set your setting as a Preset.</p> <p>How to recall the Preset: Please press the desired “Preset No.” button (Preset 1 to Preset 4) directly and then the presaved Preset settings will be recalled successfully.</p>

No	Function Keys	Descriptions
4	<p>Focus Far/ Focus Near</p> 	<p>Focus Far/Focus Near</p> <p>Please press the “Focus Far” or “Focus Near” button to shift the PTC-285NDI camera to “Manual” Mode.</p> <p>The “Focus Far” function allows you to focus on the distance.</p> <p>The “Focus Near” function allows you to focus on close distance.</p>
5	<p>Zoom Tele/Zoom Wide Button</p> 	<p>Zoom Tale/Zoom Wide Button</p> <p>The Zoom Tale/Zoom Wide button allows you to zoom out and zoom in the subject. “Zoom Tale” allows you to zoom in the subject and “Zoom Wide” allows you to zoom out the subject.</p>
6	<p>Micro Joystick</p> 	<p>Micro Joystick: Up/Down/Left/Right/Confirm</p> <p>Please move the “Micro Joystick” to the up, down, left and right sides to move the camera lens to the up, down left and right sides. When the OSD menu is turned on, please move the micro joystick to the up side or down side to select different options. Please move the micro joystick to the left or right side to select different setting values. After that, please press the “Micro Joystick” to confirm your selected value.</p>
7	<p>Reset IP Button</p> 	<p>Reset IP Button</p> <p>Please long-press this button for 3 seconds. If there is no DHCP Network environment, the IP address of the PTC-285NDI will be changed to 192.168.100.100 automatically.</p>

No	Function Keys	Descriptions
8	<p>STR Button</p> 	<p>STR Button Please press this button and the “Preset 1 to Preset 4” buttons to save your desired Preset.</p> <ul style="list-style-type: none"> After you desired setting values and camera lens position are set, please press the “STR” button and then press the button of your desired Preset number from “Preset 1 to Preset 4”. After that, the Preset is set successfully.
9	<p>AF Auto Focus/AI Auto-Tracking On/Off Button</p> 	<p>Auto Focus Button/AI Auto-Tracking On/Off Button Please press this button to turn on the Auto Focus function. Please long-press this button for 2 seconds to turn on or turn off the AI Auto-Tracking function.</p>
10	<p>Back Button</p> 	<p>Back Button Please press the “Back” button to turn the camera head back to the “Home” position. When the OSD menu is opened, you can go back to the previous layer of the OSD menu by pressing the “Back” button.</p>
11	<p>Menu Button</p> 	<p>Menu Button Please press the “Menu” button to open the OSD menu of the PTC-285NDI camera on the external monitor.</p>

5.2 OSD Menu

On-Screen Menu allows the user to modify various camera settings. Press **[MENU]** on the **remote control** to open the on-screen menu as shown below.

OSD Menu
Exposure
Color
Image
P/T/Z
Tracking Config
Setup
Communication Setup
Information
Restore Default
【Home】 Enter
【Menu】 Exit

The table below summarizes the main option items and their sub-options.

Main Options							
	Exposure	Color	Image	P/T/Z	Tracking Config	Setup	Communication Setup
Sub-Options	Mode	WB Mode	Luminance	SpeedByZoom	Tracking	Language	Protocol
	ExpComp Mode	RG Tuning	Contrast	AF-Zone	Tracking Area	HDMI RGB Mode	V_Address
	Backlight	BG Tuning	Sharpness	AF-Sense	Figure Size	Video Format	V_AddrFix
	Gain Limit	Saturation	Flip-H	L/R Set		Audio Select	Baudrate
	Anti-Flicker	Hue	Flip-V	Display Info		SDI-3G Mode	
	Meter		B&W-Mode	Image Freeze		USB UPGRADE	
	DRC		NR3D-Level	Digital Zoom		VISCA ID	
			Style	Pre Speed		Audio Channel	
				Pre Zoom Speed			

	Information	Restore Default
Sub-Options	ARM	Restore? Yes/No
	SOC	
	Date	
	AF	
	Format	
	Model	
	IP	
	GateWay	
	NetMask	

Details of all options in the on-screen menu are listed in the table below.

Main Menu	Sub Menu	Options	Options
Exposure	Mode	Auto	
		Manual	
		SAE	
		AAE	
	ExpCompMode	Bright	
		Off	
	Backlight	On	ExpComp
		Off	-7~+7
	Gain Limit	0	
		1	
		2	
		3	
		4	
		5	
		6	
		7	
		8	
		9	
		10	
		11	
		12	
		13	
14			
15			
16			
17			
18			
19			
20			
21			
22			
Anti-Flicker	Off		

	50Hz	
	60Hz	
Meter	Average	
	Center	
	Smart	
	Top	
DRC	0	
	1	
	2	
	3	
	4	
	5	
	6	
	7	
Iris	F1.8	
	F2.0	
	F2.4	
	F2.8	
	F3.4	
	F4.0	
	F4.8	
	F5.6	
	F6.8	
	F8.0	
	F9.6	
	F11.0	
	Close	
Shutter	NTSC Shutter	PAL Shutter
	1/30	1/25
	1/60	1/50
	1/90	1/75
	1/100	1/100
	1/125	1/120
	1/180	1/150
	1/250	1/250
	1/350	1/350
	1/500	1/500
	1/725	1/725
	1/1000	1/1000

	1/1500	1/1500
	1/2000	1/2000
	1/3000	1/3000
	1/4000	1/4000
	1/6000	1/6000
	1/10000	1/10000
Gain	0	
	1	
	2	
	3	
	4	
	5	
	6	
	7	
	8	
	9	
	10	
	11	
	12	
	13	
	14	
	15	
	16	
	17	
	18	
	19	
	20	
	21	
	22	
Bright	0	
	1	
	2	
	3	
	4	
	5	
	6	
	7	
	8	
	9	
	10	
	11	
	12	
	13	
	14	
15		

		16
		17
Color	WB Mode	Auto
		Indoor
		Outdoor
		OnePush
		Manual
		VAR
	RG Tuning	0
		+1
		+2
		+3
		+4
		+5
		+6
		+7
		+8
		+9
		+10
		-10
		-9
		-8
		-7
		-6
		-5
		-4
		-3
		-2
	-1	
	BG Tuning	0
		+1
		+2
		+3
		+4
		+5
+6		
+7		
+8		
+9		
+10		
-10		
-9		
-8		
-7		
-6		
-5		
-4		
-3		
-2		
-1		
Saturation	60%	

	70%
	80%
	90%
	100%
	110%
	120%
	130%
	140%
	150%
	160%
	170%
	180%
	190%
	200%
Hue	0
	1
	2
	3
	4
	5
	6
	7
	8
	9
	10
	11
	12
	13
14	
RG	0~255
BG	0~255
Color Temp	2500K
	2600K
	2700K
	2800K
	2900K
	3000K
	3100K
	3200K
	3300K
	3400K
	3500K
	3600K
	3700K
3800K	
3900K	

		4000K
		4100K
		4200K
		4300K
		4400K
		4500K
		4600K
		4700K
		4800K
		4900K
		5000K
		5100K
		5200K
		5300K
		5400K
		5500K
		5600K
		5700K
		5800K
		5900K
		6000K
		6100K
		6200K
		6300K
		6400K
		6500K
		6600K
		6700K
		6800K
		6900K
		7000K
		7100K
		7200K
		7300K
		7400K
		7500K
		7600K
		7700K
		7800K
		7900K
		8000K
Image	Luminance	0
		1
		2
		3
		4
		5
		6
		7
		8
		9

	10	
	11	
	12	
	13	
	14	
Contrast	0	
	1	
	2	
	3	
	4	
	5	
	6	
	7	
	8	
	9	
	10	
	11	
	12	
	13	
14		
Sharpness	Auto	
	0	
	1	
	2	
	3	
	4	
	5	
	6	
	7	
	8	
	9	
	10	
	11	
	12	
	13	
14		
15		
Flip-H	Off	
	On	
Flip-V	Off	
	On	
B&W-Mode	Off	
	On	
NR3D-Level	Auto	
	Off	
	1	
	2	
	3	
	4	

		5	
		6	
		7	
		8	
	Style	Default	
		Norm	
		Bright	
		PC	
	SpeedByZoom	Off	
		On	
	AF-Zone	Front	
		Top	
		Center	
		Bottom	
	AF-Sense	High	
		Low	
		Normal	
	L/R Set	STD	
		REV	
	Display Info	Off	
		On	
	Image Freeze	On	
		Off	
	Digital Zoom	Off	
		2x	
		4x	
		8x	
		16x	
P/T/Z	Pre Speed	1	
		2	
		3	
		4	
		5	
		6	
		7	
		8	
		9	
		10	
		11	
		12	
		13	
		14	
		15	
		16	
		17	
		18	
		19	
		20	
21			
22			
23			

		24	
		0	
		1	
		2	
		3	
		4	
		5	
		6	
		7	
Tracking Config	Tracking	On	
		Off	
	Tracking Area	Presenter	
		Zone	
	Figure Size	Full	
		Half-Body	
Close Up			
Setup	Language	繁體	
		EN	
		中文	
	HDMI RGB Mode	HDMI	Note: There is NO DVI Mode for 4K50/59/60
		DVI	
	Video Format	1080P25	
		720P50	
		1080P60	
		1080P50	
		1080I60	
		1080I50	
		1080P30	
		720P60	
		1080P29.97	
		1080I59.94	
		1080P59.94	
		720P59.94	
		4KP29.97	
		4KP59.94	
		4KP25	
	4KP30		
	4KP50		
	4KP60		
	Audio Select	MIC	
		LINE IN	
	SDI-3G Mode	LEVEL-A	
		LEVEL-B	
	USB UPGRADE	Off	
		On	
	VISCA ID	By DIP	
By OSD			
Audio Channel	Stereo		
	Mono		

Communication Setup	Protocol	VISCA
		PELCO-D
		PELCO-P
		Auto
	V_Address	1
	V_AddrFix	Off
		On
	Baudrate	38400
		2400
		4800
9600		
Information	ARM	
	SOC	
	Date	
	AF	
	Format	
	Model	
	IP	
	GateWay	
NetMask		
Restore Default	Restore?	

Note: For the “Audio Channel” option in the OSD menu, if the “mono” is selected, the data for the left audio channel will be copied to the right audio channel and they will output together. If the audio source is “mono”, only the left audio channel will output the audio.

5.3 Professional Jargon Explanations of the OSD

Menu

There are some professional jargons or nouns which are shown in the OSD menu of the PTC-285NDI camera, please refer to this section for realizing those jargons.

- **Speed by Zoom:** When this function is turned “ON”, at the time when the zoom-in/zoom out is beginning or it is about to reach the zoom-in/zoom-out limit or users want to stop zooming in/zooming out, the zoom-in/zoom-out speed of the camera lens will be reduced linearly. When this function is turned “OFF”, the zoom-in/zoom-out speed will be consistent no matter when the camera zoom-in is started or stopped.

- Flip-H: This is the “Horizontal Flipping”. When “ON” is selected, the screen which is shot by the camera will flip horizontally. If “OFF” is selected, the screen will be shown in normal direction.
- Flip-V: This is the “Vertical Flipping”. When “ON” is selected, the screen which is shot by the camera will flip vertically. If “OFF” is selected, the screen will be shown in normal direction.
- L/R Set: If the “REV” is selected for this option, the panning direction of the PTC-285NDI camera lens will be opposite to the direction which is controlled by the remote controller. If the “STD” is selected for this option, the panning direction of the camera lens will be the same as the direction which is selected by the remote controller.

6. Instruction for installation

Note: Only mount the bracket on formwork or concrete surface. Do NOT mount the bracket on plasterboard.

Step 1 – DIP Switch Setting

Set the Mirror option to H+V mode.

Step 2 – One End of Retaining Wire

Attach the retaining wire to the junction box mounted on the ceiling by screwing one end of the retaining wire into a screw hole in the junction box with a screw (not supplied) as shown in the diagram below.

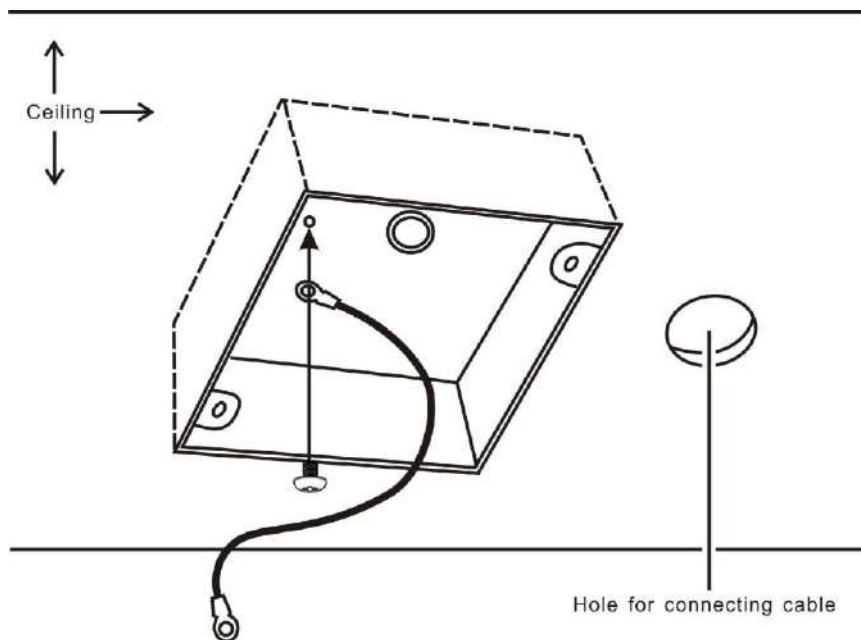

Step 3 – Ceiling Bracket (B)

Again, as illustrated in the diagram below, screw a ceiling bracket (B) into the junction box mounted on the ceiling.

Make sure the screw holes of the ceiling bracket (B) are aligned with the holes on the junction box.

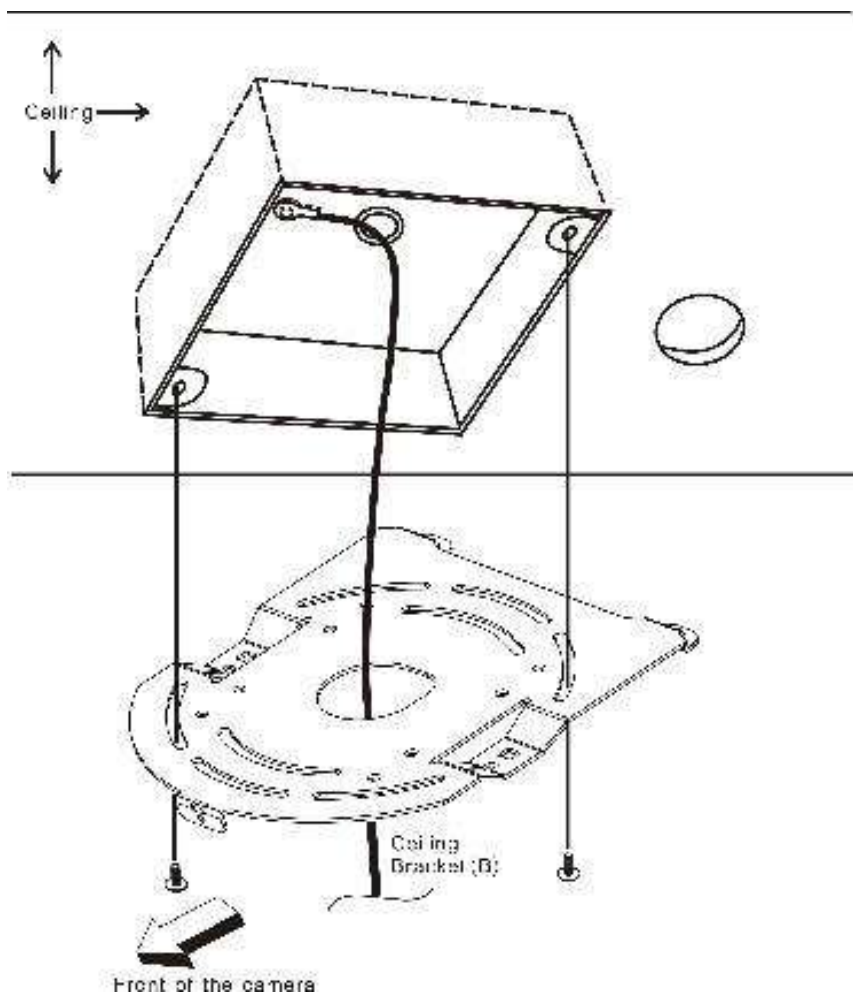

Step 4 – Ceiling Bracket (A) and Camera

- Screw ceiling bracket (A) into the bottom of the camera using three screws.
- Position the screws as shown in the diagram below.
- Align the screw holes on the bottom of the camera with those in the ceiling bracket.
- Insert the screws into the corresponding screw holes in the numbered order.
- The other end of the retaining wire is screwed into the screw hole #3.
- Securely tighten all three screws.

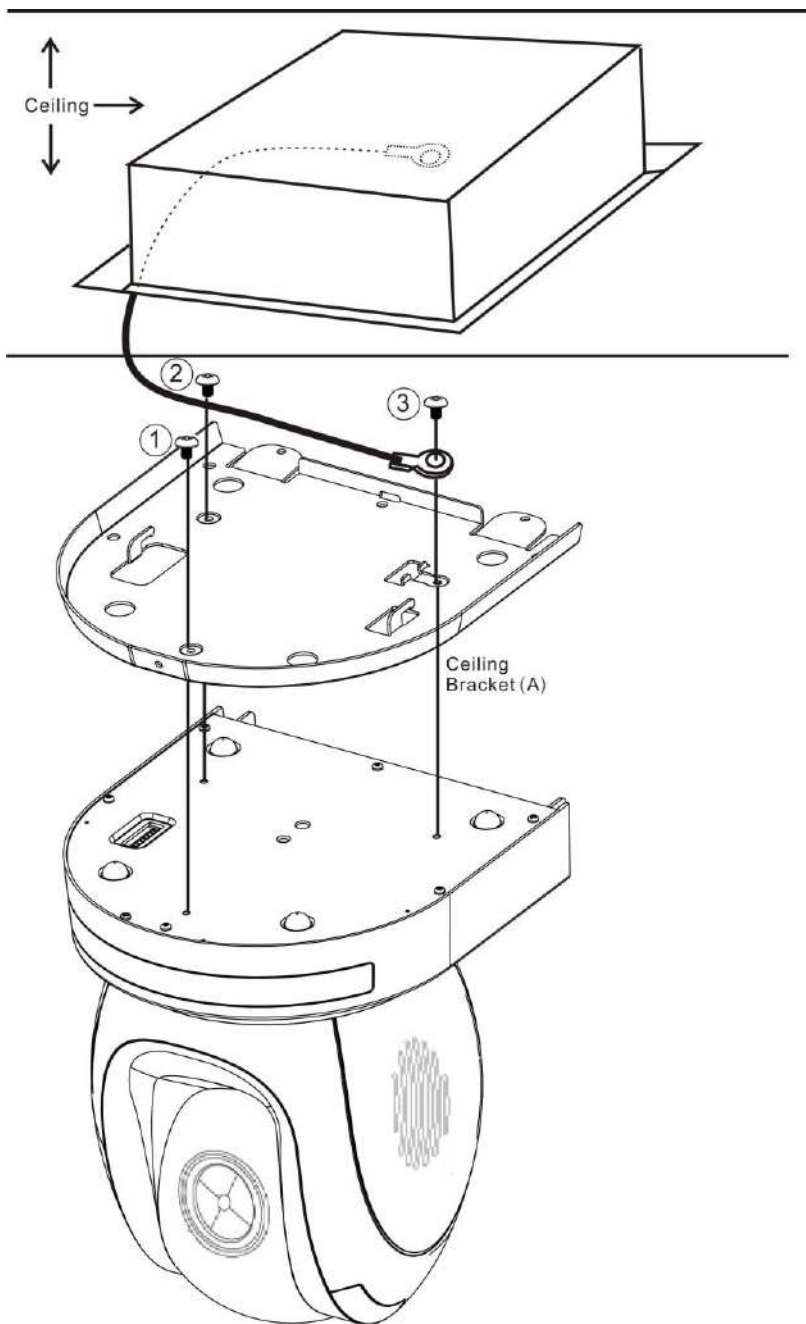

Step 5 – Mount Camera to Ceiling

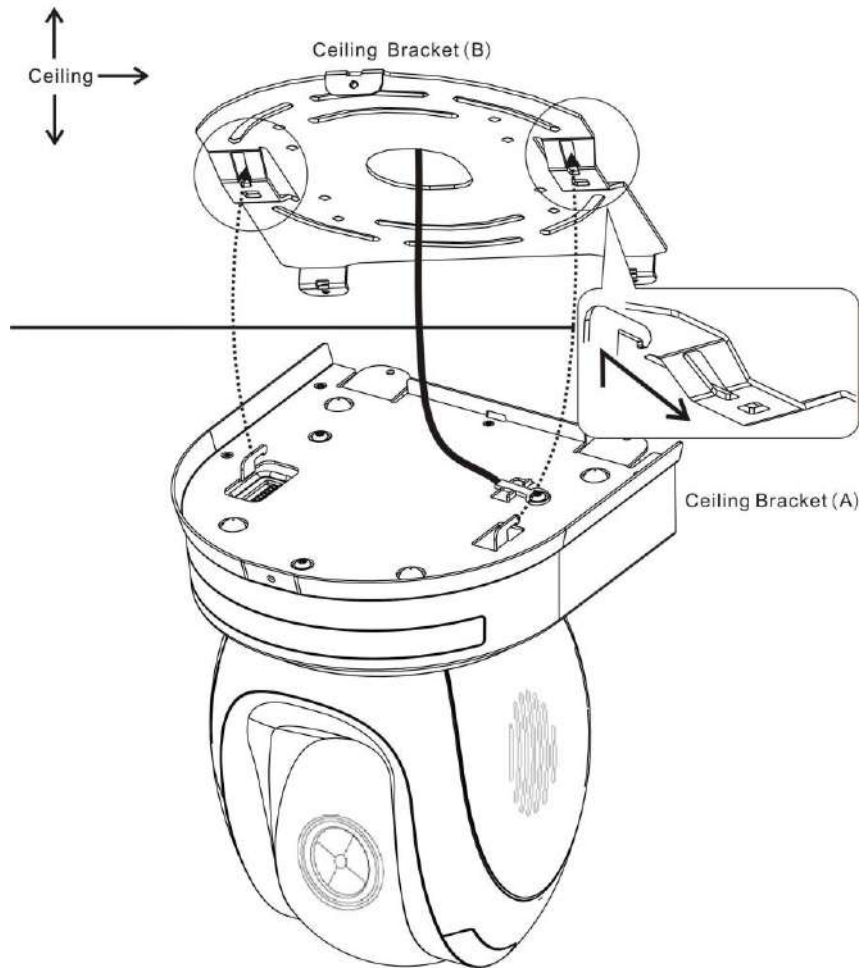

Step 6 – Screw to Fix Camera

Fix the camera by screwing three screws into the corresponding screw holes as shown in the diagram below.

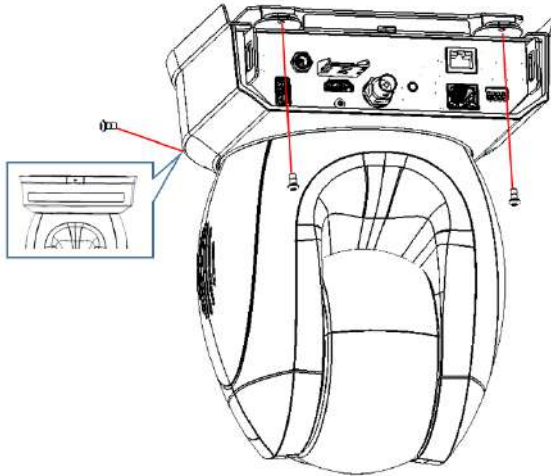

Step 7 – Cable Connection

Connect the cables to the connectors located on the rear of the camera.

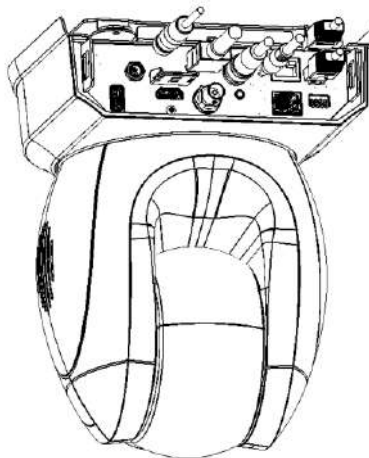

7. Network Connection

The Ethernet port on the back panel of your PTC-285NDI allows you to connect to camera from the PC/Laptop with Static or dynamic IP addresses. To access and modify these network settings, you will need to login to the camera's web interface.

If this is your first time using the device, please note that the camera's default IP address is **192.168.100.100**.

Set up direct connection between the camera and your PC/laptop as depicted in the diagram below; remember to manually assign an IP address of **192.168.100.X** to your PC/laptop.

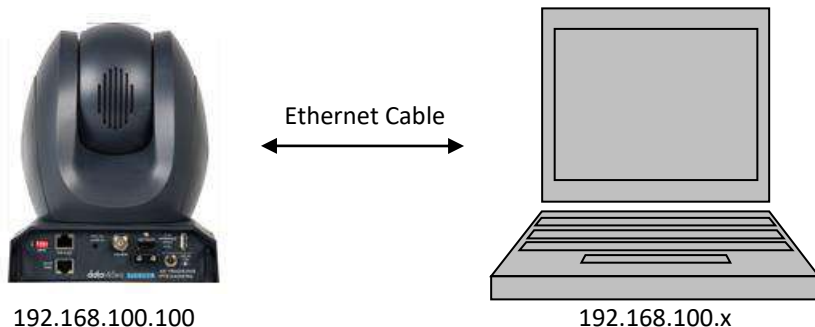

On your PC/laptop, open a web browser and in the address bar, enter the camera's default IP address, 192.168.100.100 then press the **ENTER** key which should take you to login page of the web interface.

datavideo

User name

Password

Login

[简体中文](#) | [繁体中文](#) | [English](#)

The default login credentials are:

- User Name: admin
- Password: admin

After users login into the web user interface successfully, please click the “Network” option and then please click the “IP Configuration Type” drop-down menu from the “Lan Settings” area to modify the connection type of the camera to DHCP or Fixed IP. If the “Fixed IP Address” is selected, it will be set in fixed IP mode. If the “Dynamic IP Address” is selected, it will be set in DHCP mode. After the setting is finished, please click the “Apply” button for completing the setting.

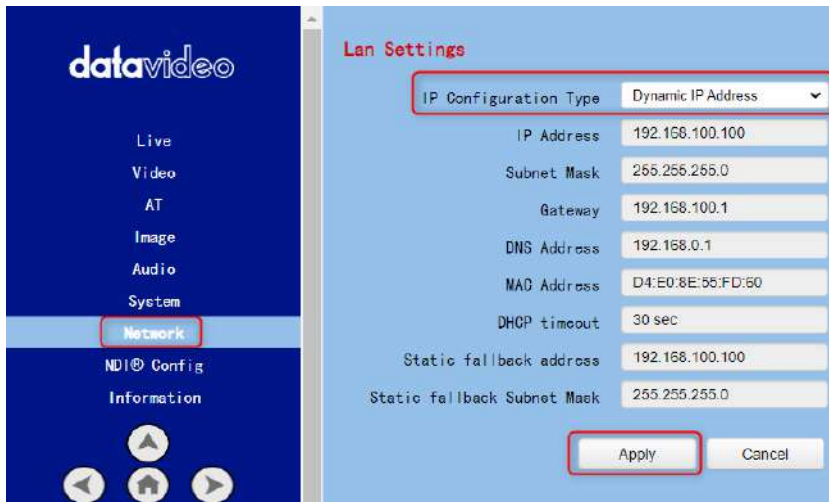

In following two chapters, we will show you how to enable DHCP and Static IP modes in two separate sections.

7.1 DHCP Mode

Dynamic Host Configuration Protocol (DHCP) is a network protocol that enables a server to automatically assign an IP address to a network device from a defined range of numbers configured for a given network. The diagram below illustrates a DHCP network connection example.



In order to enable the DHCP mode of the camera, please select “Dynamic IP Address” from the “IP Configuration Type” drop-down menu for assigning a dynamic IP address to PTC-285NDI by the router. After that, please click the “**Apply**” button to save the new settings and then please reboot the PTC-285NDI.

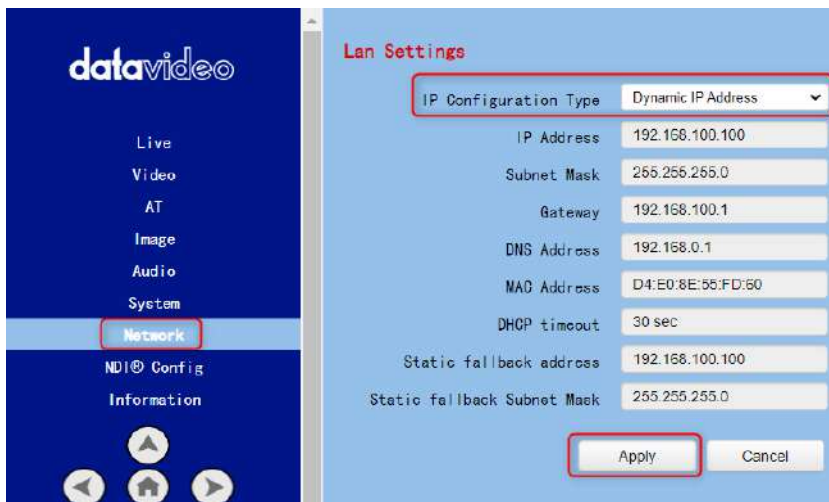

7.2 Static IP

A static IP address is a fixed address manually assigned to PTC-285NDI. First please select “Fixed IP Address” from the “IP Configuration Type” drop-down menu and then please enter an IP address for the camera, the subnet mask and the gateway IP.

Note: Never assign an address that ends in .0 or .255 as these addresses are typically reserved for network protocols. An address to the very start of the IP pool is also not recommended as it is always reserved for the router.

After the Static IP address is set, please click the “Apply” button for saving new settings and then please reboot the PTC-285NDI.

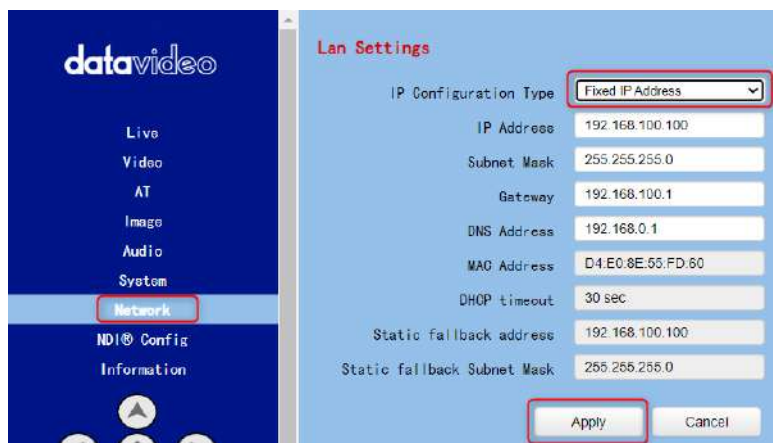

The screenshot displays the 'datavideo' web interface. On the left is a navigation menu with options: Live, Video, AT, Image, Audio, System, Network (highlighted with a red box), NDI® Config, and Information. The main area is titled 'Lan Settings' and contains the following configuration fields:

Field	Value
IP Configuration Type	Fixed IP Address (dropdown menu, highlighted with a red box)
IP Address	192.168.100.100
Subnet Mask	255.255.255.0
Gateway	192.168.100.1
DNS Address	192.168.0.1
MAC Address	D4:E0:8E:55:FD:60
DHCP timeout	30 sec
Static fallback address	192.168.100.100
Static fallback Subnet Mask	255.255.255.0

At the bottom right, there are two buttons: 'Apply' (highlighted with a red box) and 'Cancel'.

7.3 DVIP

DVIP is a special network configuration software tool designed for DVIP device search on the same network and configuring device network settings such as Hostname, DHCP mode, IP address, subnet mask, gateway IP, and primary and secondary DNS.

Depending on your operating system, download DVIP Configuration Tool from the respective sites listed as follows:

PC: <https://www.microsoft.com/en-us/p/dvip-network-config/9p6gtz839k6s?activetab=pivot%3Aoverviewtab>

Android:

https://play.google.com/store/apps/details?id=com.datavideo.dvipnetconfig&hl=en_US

iOS: <https://itunes.apple.com/tw/app/dvip-network-config/id1177895983?mt=8>

After you've installed the DVIP Network Configuration Tool, follow the steps outlined below to scan for online DVIP devices and configure their corresponding settings.

Step 1: Open the DVIP Network Configuration Tool and then select the connected Ethernet option from the "Network interface" pop-up window. After that please press the "OK" button



Step 2: After the Network interface is selected, the DVIP Network Configuration Tool interface will be shown as following diagram.



Step 3: Please press “PTC-285” and then the network settings pop-up window will be shown.

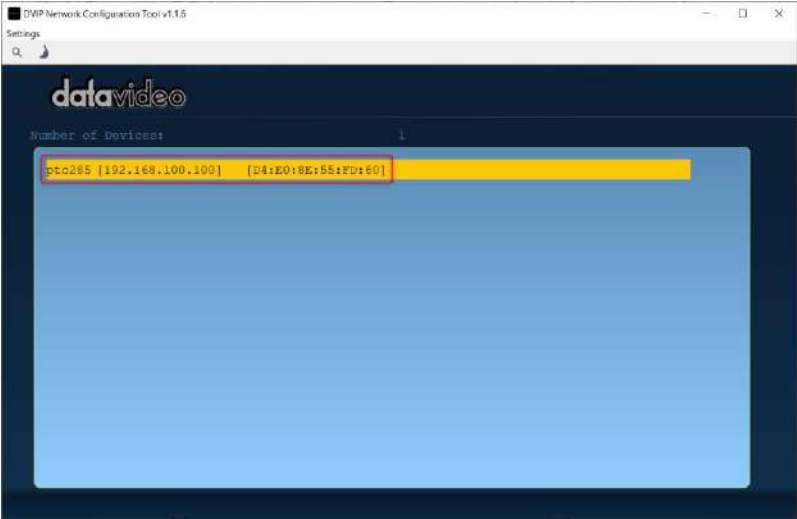

Host Name ptc285

Model Name PTC-285
(VID:0103, PID:3013)

MAC address D4:E0:8E:55:FD:60

IP address 192.168.100.100

Using Fixed IP Mode

Mask 255.255.255.0

Gateway 192.168.100.1

Primary DNS 192.168.0.1

Secondary DNS 8.8.8.8

Default Save

Step 4: users can click “Host Name” column for changing the device name. Users can also click each setting column for changing value if it is needed. After that, please press “Save” for saving those settings. Users can also press “Default” for resuming those settings to factory default value.

Host Name ptc285

Model Name PTC-285
(VID:0103, PID:3013)

MAC address D4:E0:8E:55:FD:60

IP address 192.168.100.100

Using Fixed IP Mode

Mask 255.255.255.0

Gateway 192.168.100.1

Primary DNS 192.168.0.1

Secondary DNS 8.8.8.8

Default Save

8. How to Use PTC-285NDI's AI Auto Tracking

The Datavideo PTC-285NDI is a 4K Tracking PTZ camera. There are two tracking modes for the PTC-285 NDI's AI Auto-Tracking function including "Presenter" and "Zone" Modes. Please refer to the following sections for operating the Auto-Tracking function of the PTC-285NDI.

8.1 How to turn on the AI Auto-Tracking Function by the remote controller

Please follow the following steps for turning on PTC-285NDI's AI Auto-Tracking function.

1. Please use PTC-285NDI's remote controller to turn on the AI Auto-Tracking function. Please long-press the "AF/AI" button  of the remote controller for 2 seconds.

2. At this time, PTC-285NDI's AI Auto-Tracking function will be turned on. There is a reminder "Start Tracking" that will be shown on the OSD of the external monitor which is connected to the PTC-285NDI. This means that the AI Auto-Tracking function is turned on successfully.

8.2 How to turn off the AI Auto-Tracking Function by the remote controller

Please follow the following steps for turning off the PTC-285NDI's AI Auto-Tracking function.

1. Please use PTC-285NDI's remote controller to turn off the AI Auto-Tracking function. Please long-press the "AF/AI" button  of the remote controller for 2 seconds.

2. At this time, PTC-285NDI's AI Auto-Tracking function will be turned off.

8.3 How to set the AI Auto-Tracking function by the OSD Menu

The PTC-285NDI allows you to use the remote controller to open the OSD - menu for setting the AI Auto-Tracking function. Please follow the steps below to set the AI Auto-Tracking related settings.



1. At first, please press the “Menu” button from the remote controller to open the PTC-285NDI OSD menu on the connected monitor.
2. After that, please use the micro joystick to select “Tracking Config>Tracking” in order to turn on or turn off the AI Auto-Tracking function. Moreover, you can use the micro joystick to select “Tracking Config>Tracking Area” to select your desired Auto-Tracking mode from “Presenter” Mode or “Zone” Mode. You can also use the micro joystick to select “Tracking Config>Figure Size” to select your desired automatic zooming settings from “Full”, “Half Body” and “Close Up”.

8.4 How to set the AI Auto-Tracking (Presenter Mode) by the Web UI

You can also use the PTC-285NDI Web UI to set the AI Auto-Tracking function. Please follow the steps below to set the Auto-Tracking function by the Web UI.

1. The factory default of the PTC-285NDI is the DHCP mode. Please connect your PTC-285NDI and laptop or PC to a router and please make sure that they are set within the same IP range.
2. Please use Datavideo DVIP Network Configuration Tool to get the IP address of your PTC-285NDI and then please use the web browser to open the PTC-285NDI Web UI. After that, please click the “AT” option and then you can see that there are two tabs including “Presenter” and “Zone”. You can select “Current Location” or “Preset 1” from the drop-down menu of the “Presenter” tab to be the initial position of the camera lens for Auto-Tracking. The “Auto Zoom” and “Auto Tilt” are checked by default. You can also set the automatic zooming level of the camera lens by selecting “Full”, “Half Body” or “Close Up” from the “Figure Size” option.

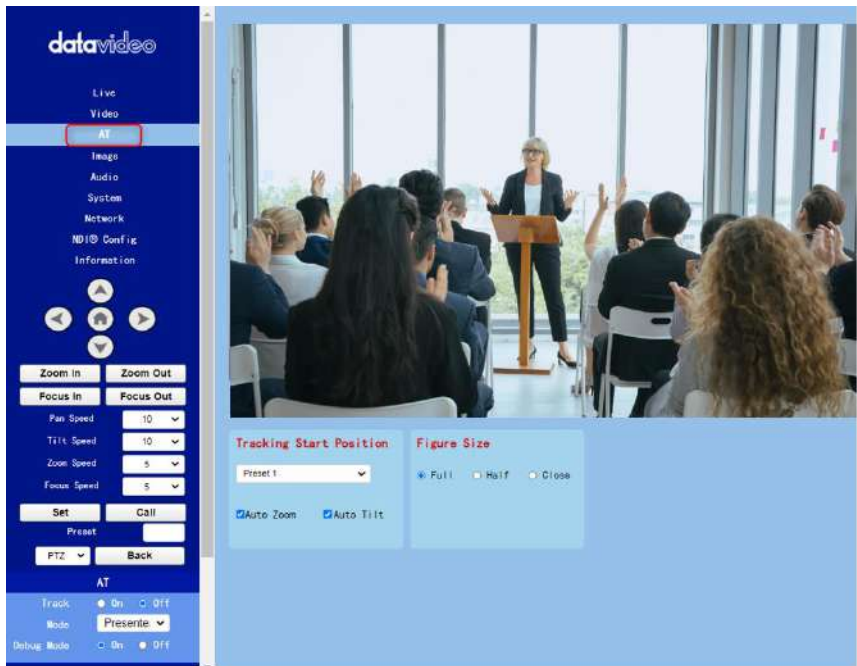

8.5 How to set the AI Auto-Tracking by the Web UI (Zone Mode)

The “Zone” Mode for the PTC-285NDI Auto-Tracking allows you to set 1 to 4 tracking areas (Zone A/Zone B/Zone C/Zone D). You have to set at least 2 tracking zones and the maximum is up to 4 tracking zones. Please pay attention that for setting the tracking zone in “Zone” Mode, you have to set your desired tracking zones “from the left side to the right side” and the edge for each zone must be overlapped.

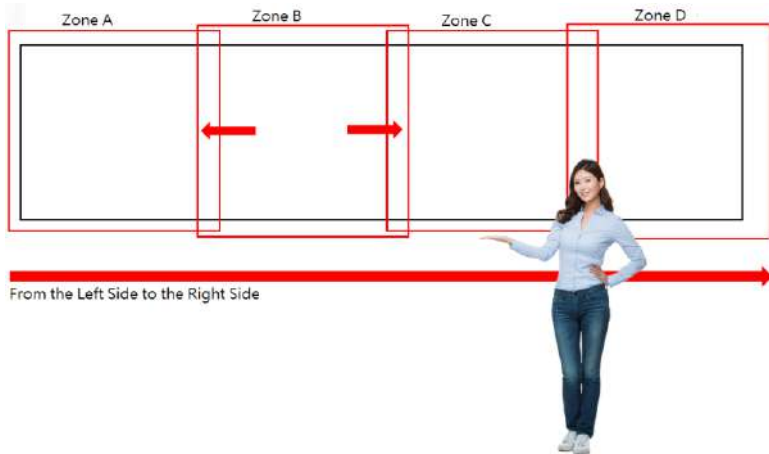

This section will take the settings for “Zone A” as an example. The way for setting Zone B to Zone D is the same as Zone A. Please refer to the steps below to set the related settings of the Zone Tracking Mode.

1. At first, please click “AT>Zone” to enter the “Zone” interface.
2. Please set your desired camera settings and camera lens angle in advance and then please click the “Zone Setting” drop-down menu. After that, please select “Zone A” and then press the “Save” button.

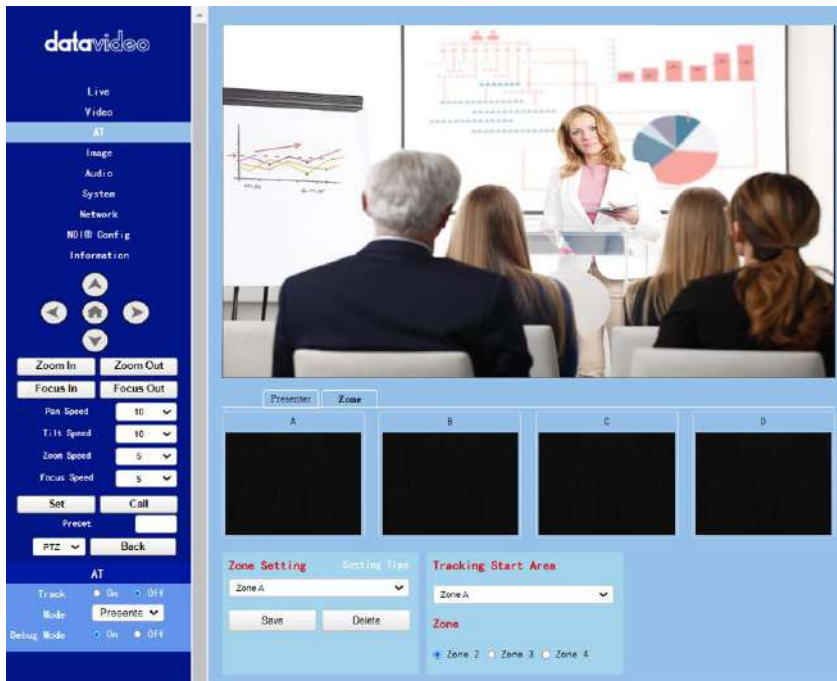

3. Please select your desired tracking start area from the “Tracking Start Area” drop-down menu’s Zone A, Zone B, Zone C and Zone D. After that, please select “Zone 2”, “Zone 3” or “Zone 4” from “Zone” option. For example, if the Zone 2 is set, the zone tracking area will from “Zone A” to “Zone B”.

The screenshot displays the datavideo PTZ control interface. On the left is a dark blue sidebar with the 'datavideo' logo and a menu including Live, Video, AT, Image, Audio, System, Network, NDIO Config, and Information. Below the menu are navigation arrows and control buttons for Zoom In/Out, Focus In/Out, Pan Speed (10), Tilt Speed (10), Zoom Speed (5), and Focus Speed (5). There are also Set, Call, Present, PTZ, and Back buttons, along with AT settings for Track (On/Off), Back (Present), and Debug Mode (On/Off).

The main area shows a live video feed of a woman in a white blazer presenting to an audience. Below the video are four zone selection buttons labeled A, B, C, and D. A 'Zone Setting' panel is open, showing 'Zone A' selected in a dropdown menu. A red box highlights the 'Tracking Start Area' section, which includes a 'Zone' dropdown menu (currently set to 'Zone A') and radio buttons for 'Zone 2', 'Zone 3', and 'Zone 4'. 'Save' and 'Delete' buttons are also visible.

9. Web User Interface

The web based user interface allows you to set and control your PTC-285NDI devices.

9.1 Live

Live option allows users to preview the image which is shot by the PTC-285NDI in a real-time basis. Please click the “Live” option and then users can preview the image which is shot by the PTC-285NDI camera from the preview window.

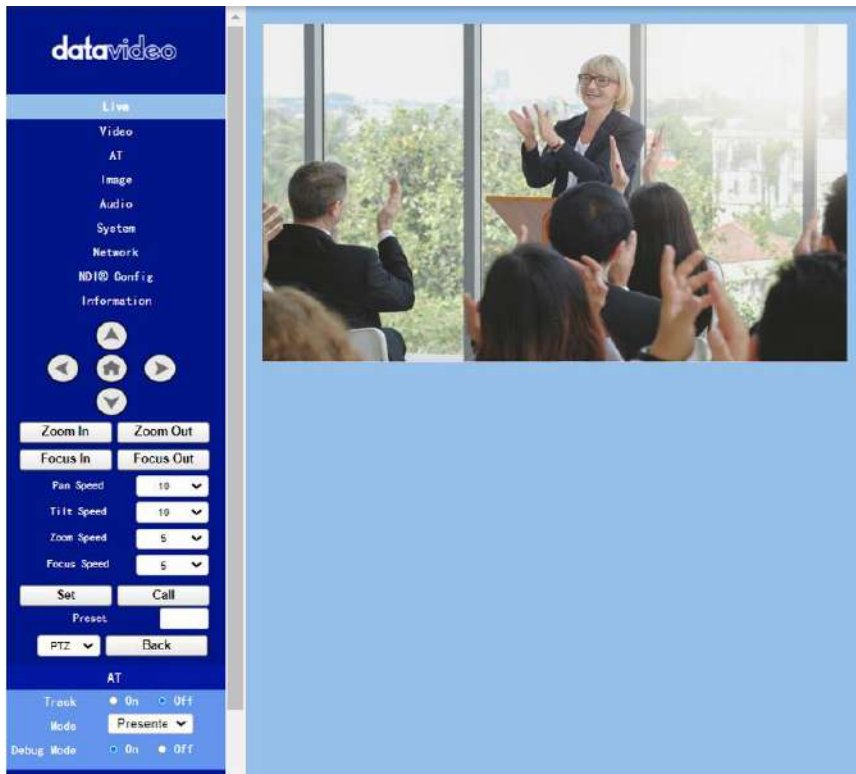

9.2 Video

“Video” option allows users to set various parameters including Video Format, Encode Level and NDI®Preset. Moreover, it also allows users to set the Encode Protocol, Resolution, Bit Rate, Frame Rate, I Key Frame Interval and Bit Rate Control for the First stream and Second stream. The main interface for the Video option is shown in the following diagram.

The screenshot displays the 'datavideo' interface. On the left is a dark blue sidebar with a menu: Live, Video (highlighted), AT, Image, Audio, System, Network, NDI® Config, and Information. Below the menu are navigation arrows and buttons for Zoom In, Zoom Out, Focus In, Focus Out, Pan Speed (10), Tilt Speed (10), Zoom Speed (5), Focus Speed (5), Set, Call, Preset, PTZ (dropdown), and Back. At the bottom of the sidebar are AT controls: Track (On/Off), Mode (Presente), and Debug Mode (On/Off).

The main content area is titled 'Video Settings' and contains the following configuration options:



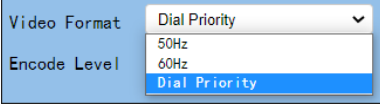
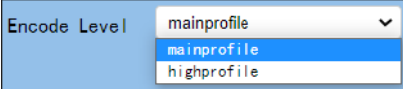
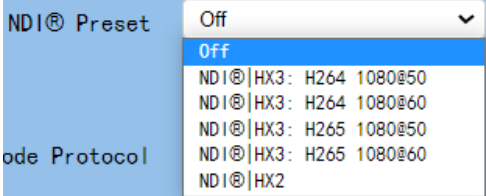

- Video Settings:**
 - Video Format: Dial Priority
 - Encode Level: mainprofile
 - NDI® Preset: Off
- First stream:**
 - Encode Protocol: H264
 - Resolution: 1920x1080
 - Bit Rate: 4096
 - Frame Rate: 30 fps
 - I Key Frame Interval: 30
 - Bit Rate Control: CBR
- Second stream:**
 - Encode Protocol: H264
 - Resolution: 320x240
 - Bit Rate: 1024
 - Frame Rate: 30 fps
 - I Key Frame Interval: 30
 - Bit Rate Control: CBR

At the bottom right of the settings area are 'Apply' and 'Cancel' buttons.

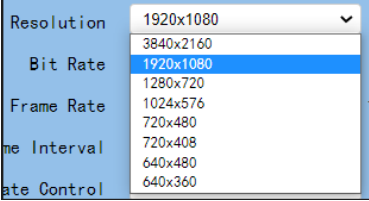
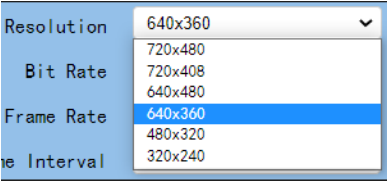
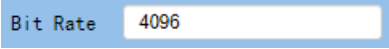
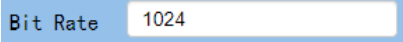
Please see the following section for realizing the descriptions for each item for the Video option.

Items	Descriptions
 <p>Video Format Encode Level</p>	<p>Video Format</p> <p>It can support three video formats including 50Hz(PAL), 60Hz(NTSC) and Dial Priority.</p>
<ul style="list-style-type: none"> ● 50Hz (PAL): If you select this option, the maximum frame rate per second (FPS) for the streaming video will be 50. ● 60Hz (NTSC): If you select this option, the maximum frame rate per second for the streaming video will be 60. ● Dial Priority: If you select this option, the maximum frame rate per second will be 30, and it is possible that the parameters including the video format and frame rate will be affected by the camera OSD menu settings. <p>Note:</p> <ol style="list-style-type: none"> 1. If you want to use the PTC-285NDI camera to connect to some Datavideo switchers which support the interlace format only such as the HS-1300, SE-120 MU and SE-650, please remember to select the “Dial Priority” option as your video format. 2. If the 50Hz or the 60Hz is selected for the PTC-285NDI web UI, the SDI or the HDMI output format of the PTC-285NDI camera will be fixed at 1080p 50/60. 	
 <p>Encode Level</p>	<p>Encode Level</p> <p>It allows users to select needed Encode Level from two Encode Levels including mainprofile and highprofile.</p>
 <p>NDI® Preset Encode Protocol</p>	<p>NDI®Preset</p> <p>It allows you to set the output video format and resolution of the NDI®HX3. You can also select NDI®HX2. If “Off” is selected, the NDI function will be turned off.</p>

Items	Descriptions
	<p>Encode Protocol (First Stream & Second Stream)</p> <p>It allows users to select three Encode Protocols including H.264, H.265 and MJPEG for the “First Stream” and “Second Stream”.</p>
<p>Resolution for the first stream</p> 	<p>Resolution (First Stream & Second Stream)</p> <p>There are two drop-down menus including the resolution for the First Stream and the resolution for the Second Stream for users to select different resolution. When the resolution is higher, the image will become clearer. However, it will occupy more network bandwidth.</p>
<p>Resolution for the second stream</p> 	
	<p>Bit Rate (First Stream & Second Stream)</p> <p>It allows users to determine the Bit Rate range by themselves. The range for the Bit Rate for the first stream is from 32-51200kbps. The range for the Bit Rate for the second stream is from 32-20480kbps.</p> <p>Note: If the network bandwidth is too narrow and the Bit Rate setting is too high, it will cause that the video streaming can not be transferred normally and it</p>
	

Items	Descriptions
	<p>will cause a poor visual effect for viewers.</p> <p>Frame Rate (First Stream & Second Stream)</p> <p>Users can set the Frame Rate from the drop-down menu by themselves. The range is from 1 to 60. When the Frame Rate value is higher, the image will be smoother. When the Frame Rate value is lower, it will cause an unsmooth image.</p>
	<p>I Key Frame Interval (First Stream & Second Stream)</p> <p>It allows users to set the interval between two I frames. When the interval is larger, the response speed from the viewing window will be lower.</p>
	<p>Bit Rate Control (First Stream & Second Stream)</p> <p>There are two ways for Bit Rate Control including the CBR and VBR.</p> <p>CBR: The video encoder will encode the video according to the default speed.</p> <p>VBR: The video encoder will encode the video by adjusting the encoding speed according to the default value in order to achieve best image quality.</p>
	<p>Apply Key</p> <p>After all of the options are set, please click the “Apply” key and then all of the changes</p>

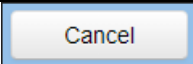
Items	Descriptions
	will be effective.
	Cancel Key If the “Cancel” key is pressed, all of the changes will not take effect.

9.2.1 How to Connect the PTC-285NDI to a Datavideo Switcher after a 60FPS/50FPS Video Streaming (Take the HS-1300 as an example)

When you select the 50Hz or the 60Hz option from the [Video] → [Video Settings] drop-down menu in the PTC-285NDI web UI for streaming videos, the PTC-285NDI HDMI/SDI output will be fixed at 1080p 50/60. However, the Datavideo HS-1300 switcher supports the 1080i video format only rather than the 1080p video format. So, when you want to connect the PTC-285NDI to the HS-1300 switcher, it is necessary for you to set the PTC-285NDI again in order to make sure that the video formats for the PTC-285NDI and the HS-1300 are consistent. Moreover, it can assure that the input screen that is received by the HS-1300 can be displayed correctly. Please follow following steps for setting the PTC-285NDI and the HS-1300.

- **Take the adjustment to 1080i59.94 as an example**

Step 1. At first, please press the “MENU” button which is located on the PTC-285NDI remote controller to open the OSD menu.

Step 2. After the OSD menu is opened, please move down the “Microjoystick”



to select the “Setup” option, and then please press the “Microjoystick”



to enter the “Setup” option.

Step 3. In “Video Format” option, please move the “Microjoystick” to the left or right side to select 1080i60, 1080i59.94 or 1080i50 video format.



Step 4. Please press the “MENU” button which is located on the control panel of the HS-1300 switcher to open its OSD menu.



Step 5. Please use the down arrow button to select the “Setup” option.

Step 6. Please use the right arrow button to select “Standard” “1080i59.94”, and then please press the “Enter” button to enter this option for further adjustment.

Step 7. If the format for the “Standard” is not 1080i59.94, please use the up



arrow button and down arrow button which are located on the control panel to adjust the video format to 1080i59.94.

Step 8. Please select your desired “Standard” value and then press the “ENTER” button again to confirm your selection.



Step 9. Please press the right arrow button again to select the “Save Setup” option.

Step 10. Please use the left arrow button and the right arrow button to select the “Yes” button and then press the “ENTER” button again to save the setting.



Step 11. After the setting is saved, please press the “MENU” button to exit to the previous menu and to exit the OSD menu of the HS-1300. The “Standard” option setting for the HS-1300 is finished until this step.

Step 12. Please open the web UI of the PTC-285NDI.

Step 13. Please click the “Video” option, and then please select “Dial Priority” from the “Video Format” drop-down menu.

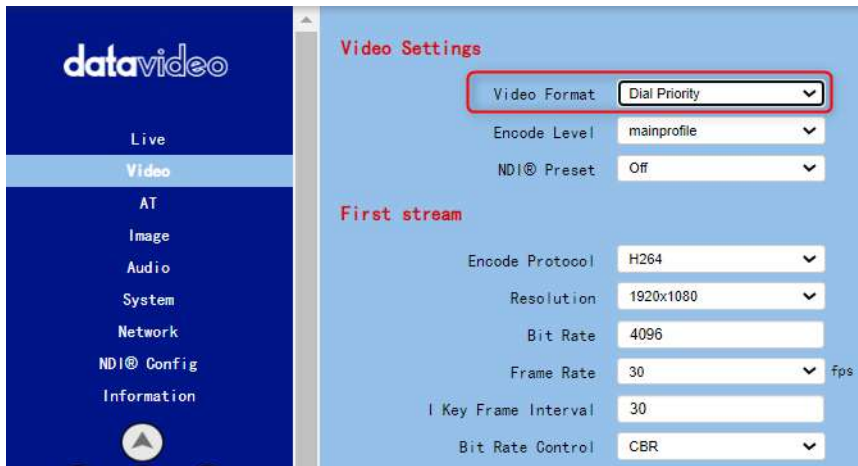

Step 14. Please click the “Apply” button .

Step 15. Please click the “Reboot” button in the “System” option to reboot the PTC-285NDI.

Step 16. After the PTC-285NDI is rebooted, please use an SDI cable to connect from the 3G-SDI interface which is located on the rear panel of the PTC-285NDI to the SDI IN interface which is located on the rear panel of the HS-1300, or you can use an HDMI cable to connect from the HDMI interface which is located on the rear panel of the PTC-285NDI to the HDMI IN interface which is located on the rear panel of the HS-1300. After that, you can see the image which is shot by the PTC-285NDI is displayed in the MULTIVIEW window of the HS-1300 correctly.

For SDI: The SDI IN 1 to SDI IN 4 interfaces which are located on the rear panel of the HS-1300 represent the MULTIVIEW window’s Input 1 to Input 4.

For HDMI: The HDMI IN 1 to HDMI IN 2 interfaces which are located on the rear panel of the HS-1300 represent the MULTIVIEW window’s Input 5 to Input 6.

Note: Datavideo’s SE-650, HS-1200 MU and HS-1300 switchers support 1080i video format only. So, the 1080p video format is not supported by the above-mentioned switchers. If you want to connect the PTC-285NDI camera to the SE-650 or the HS-1200 MU switcher, please remember to select the “Dial Priority” item from “Video→ Video Format” in the PTC-285NDI web UI. Moreover, please use the OSD menu of the PTC-285NDI camera and the OSD

menu of the above-mentioned switchers to adjust them in the same video standard before connecting to prevent the video format incompatible issue and the issue that the video that is shot by the PTC-285NDI can not be displayed normally in the MULTIVIEW window of the above-mentioned switchers.

9.3 AT(Auto-Tracking)

The “AT” option allows you to set detailed settings for PTC-285NDI’s two tracking modes including “Presenter” and “Zone” modes. For the “**Presenter**” mode, the “Tracking Start Position” drop-down menu allows you to set the start position of the auto-tracking. The “Figure Size” option allows you to select “Full”, “Half Body” or “Close Up”. For the “**Zone**” mode, the “Zone Setting” allows you to set 2 to 4 auto-tracking areas. The “Tracking Start Area” allows you to set the start area of the zone tracking. The “Zone” option allows you to set the tracking area within 2 areas to 4 areas. For details of the auto-tracking function, please refer to [Chapter 8 How to Use PTC-285NDI’s AI Auto Tracking](#).

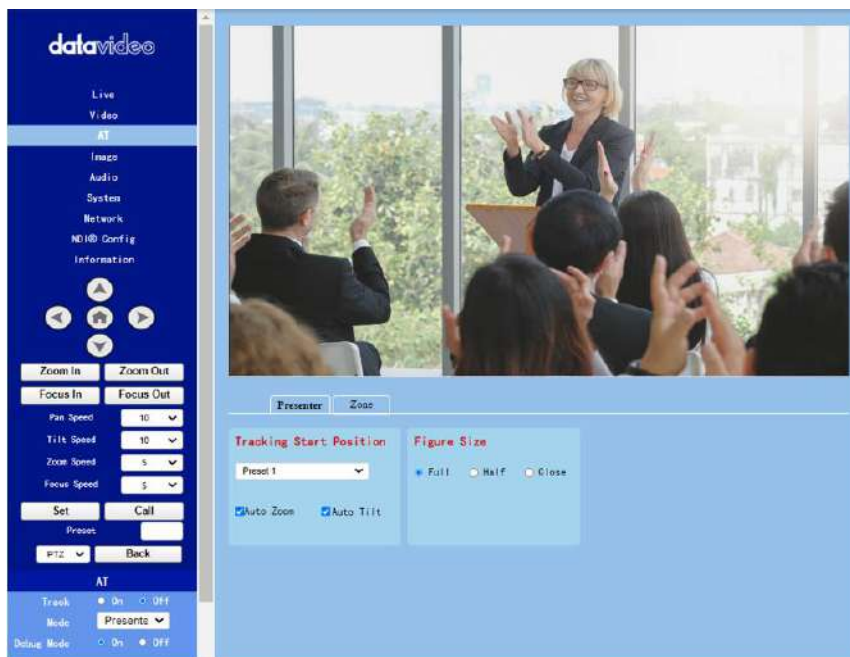

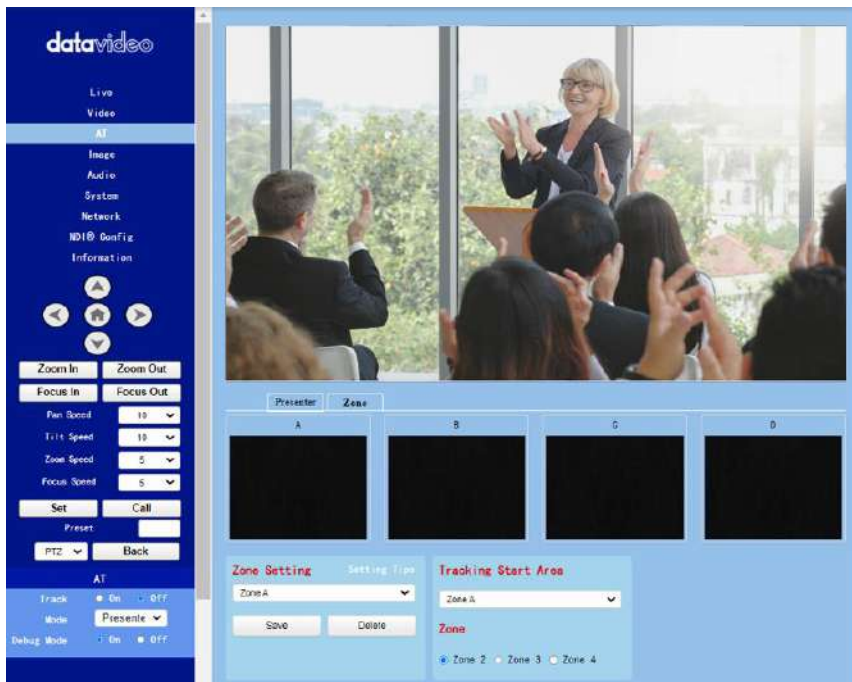

9.4 Image

The “Image” option allows users to see the image that is shot by the PTC-285NDI from the preview window. Moreover, users can adjust many parameters including Brightness, Saturation, Contrast, Sharpness and Hue from this interface by using sliders. The main interface of the Image option is shown as following diagram.

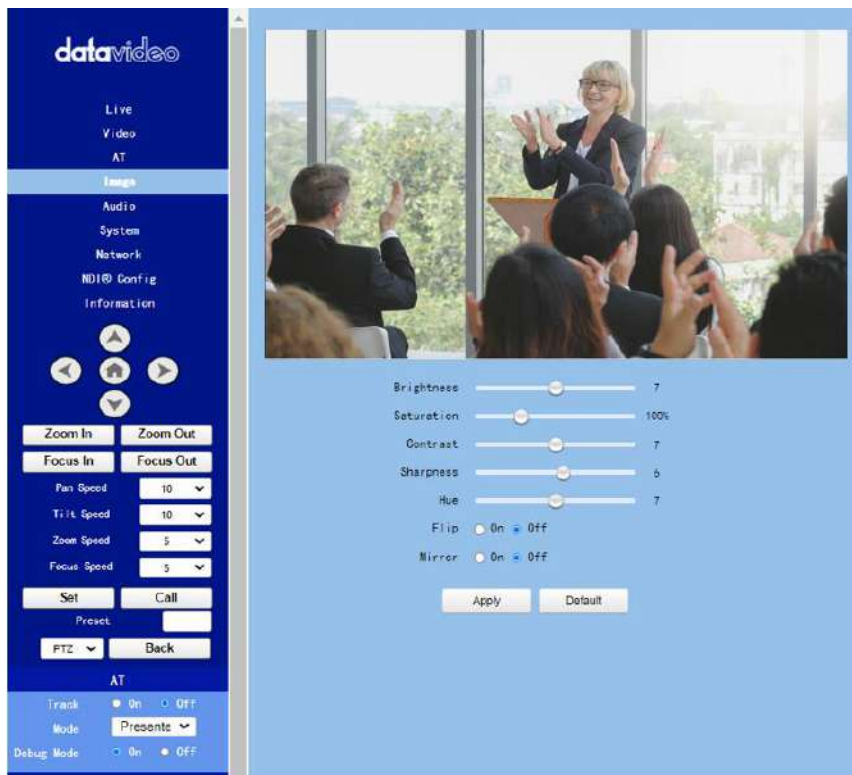

- Brightness: This option allows users to adjust the Brightness. Please use the slider for adjusting the Brightness.
- Saturation: This option allows users to adjust the Saturation. Please use the slider for adjusting the Saturation. After the adjustment is finished, please click the “Apply” button and then it is set successfully.

- Contrast: This option allows users to adjust the Contrast. Please use the slider for adjusting the Contrast. After the adjustment is finished, please click the “Apply” button and then it is set successfully.
- Sharpness: This option allows users to adjust the Sharpness. Please use the slider for adjusting the Sharpness. After the adjustment is finished, please click the “Apply” button and then it is set successfully.
- Hue: This option allows users to adjust the Hue. After the adjustment is finished, please click the “Apply” button and then it is set successfully.
- Flip: Please check the checkbox of the “Flip On” option Flip On and then please click the “Apply” button for flipping the image that is shot by the camera.
- Mirror: Please check the checkbox of the “Mirror On” option Mirror On and then please click the “Apply” button for mirroring the image that is shot by the camera.
- Default: Please click the “Default” button for restoring the settings in this page to factory default value.

9.5 Audio

The Audio option allows users to set the audio related parameters. The main interface of the audio option is shown as following diagram.

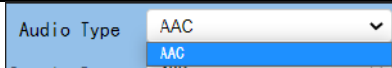
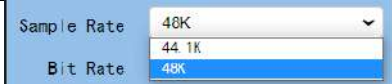
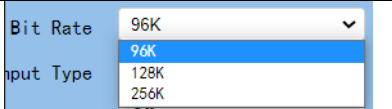
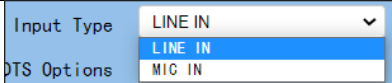
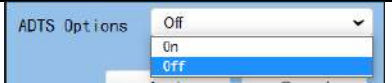

Please see following section for realizing the descriptions for each item for the Audio option.

Items	Descriptions
	<p>Audio Switch</p> <p>This option allows users to turn on or turn off the input of the audio source.</p>
	<p>Audio Type</p> <p>This allows users to select the encoding format of the input audio. The default audio type is the AAC format.</p>
	<p>Sample Rate</p> <p>This drop-down menu allows users to select desired sample rate for the input audio source. There are two sample rate including 44.1K and 48K for users to select.</p>
	<p>Bit Rate</p> <p>This drop-down menu allows users to select their desired Bit Rate.</p>
	<p>Input Type</p> <p>This option allows users to select the audio signal input way. Users can input the audio by external connected MIC or by LINE IN.</p>
	<p>ADTS Option</p> <p>This drop-down menu allows users to turn on or turn off the ADTS.</p>

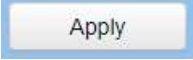
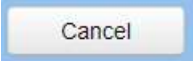



Items	Descriptions
	<p>Apply Key After all of the options are set, please click the “Apply” key and then all of the changes will be effective.</p>
	<p>Cancel Key If the “Cancel” key is pressed, all of the changes will not take effect.</p>

9.6 System

This System option allows users to select functions including Reboot, Factory default, User/Guest Name and Password. The main interface of the System option is shown as following diagram. Please pay attention that the “Factory Default” option resumes the OSD menu rather than the Web UI to its factory default settings.

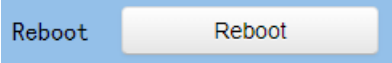

Please see following section for realizing the descriptions for each item for the System option.

Items	Descriptions
	<p>Reboot</p> <p>Press the “Reboot” button and then a reminder dialogue box will appear, please press the “OK” button for rebooting the camera.</p>
	<p>Factory Default</p> <p>Press the “Factory Default” button and then a reminder dialogue box will appear, please press the “OK” button for resuming PTC-285NDI’s OSD menu to its factory default value.</p>
	<p>User</p> <p>There are several items including Username, Password, Guest and Password for users to set the username and password for user and guest. After the setting is finished, please press the “Apply” button for applying the setting.</p> <p>The default username/Password for user is “admin/admin”.</p> <p>The default Username/Password for Guest is “guest/guest”.</p>
	<p>Apply Key</p> <p>After all of the options are set, please click the “Apply” key and then all of the changes will be effective.</p>

Items	Descriptions
<div style="border: 1px solid gray; padding: 5px; width: fit-content; margin-bottom: 10px;">Cancel</div>	<p>Cancel Key</p> <p>If the “Cancel” key is pressed, all of the changes will not take effect.</p>

9.7 Network

The Network option allows users to set many network related functions. The main interface of the Network option is shown as following diagram.

datavideo

- Live
- Video
- AT
- Image
- Audio
- System
- Network**
- NDI Config
- Information
- PTZ
- AT

Lan Settings

IP Configuration Type:

IP Address:

Subnet Mask:

Gateway:

DNS Address:

MAC Address:

DHCP timeout:

Static fallback address:

Static fallback Subnet Mask:

Port Settings

HTTP Port:

RTSP Port:

TCP Port:

UDP Port:

Sony Visca:

RTMP(S) Settings

First Stream: On Off Video Audio

MRL:

Second Stream: On Off Video Audio

MRL:

datavideo

Live
Video
AT
Image
Audio
System

Network

NDI® Config
Information

⬅️ ⬆️ ⬇️ ⬇️ ⬆️ ➡️

Zoom In **Zoom Out**

Focus In **Focus Out**

Pan Speed ▾

Tilt Speed ▾

Zoom Speed ▾

Focus Speed ▾

Set **Call**

Preset

PTZ ▾ **Back**

AT

Track On Off

Mode ▾

Debug Mode On Off

Set **Call**

Preset

PTZ ▾ **Back**

AT

Track On Off

Mode ▾

SRT Settings

SRT On Off

SRT Mode ▾

SRT Server

SRT Port

SRT Encryption ▾

SRT Password

SRT Bandwidth Overhead

SRT Variable Latency

SRT StreamId

RTSP Settings

RTSP Auth On Off

ONVIF Settings

ONVIF On Off

ONVIF Auth On Off

Multicast Settings

Multicast On Off

Address

Port

NTP Settings

NTP time sync On Off

Time Zone ▾

Server address

Time interval(min)

Main time show On Off



Position

Sub time show On Off

Position



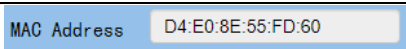
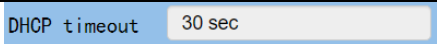

Apply **Cancel**

Please see following section for realizing the descriptions for each item for the Network option.

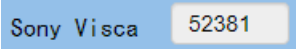
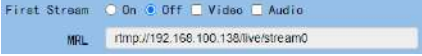
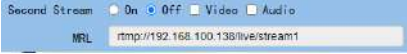
Items	Descriptions
 <p>IP Configuration Type: Dynamic IP Address IP Address: Fixed IP Address</p>	<p>IP Configuration Type This drop-down menu allows users to select the Static IP or DHCP mode. If the “Fixed IP Address” is selected, it will operate in static IP mode. If the “Dynamic IP Address” is selected, it will operate in DHCP mode.</p>
 <p>IP Address: 192.168.100.88 Subnet Mask: 255.255.255.0 Gateway: 192.168.100.1 DNS Address: 8.8.8.8</p>	<p>IP Address/Subnet Mask/Gateway/DNS Address If the fixed IP address is selected, users can set related parameters manually. After the settings are finished, please click the “Apply” button and then those settings will take effect.</p>
 <p>MAC Address: D4:E0:8E:55:FD:60</p>	<p>MAC Address This is the MAC Address and it can not be changed by users.</p>
 <p>DHCP timeout: 30 sec</p>	<p>DHCP timeout This option allows you to set the DHCP timeout seconds. If the DHCP mode can not be detected by the PTC-285ND1 within 30 seconds, it will change to static IP mode automatically.</p>

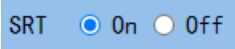
Items	Descriptions
Static fallback address <input data-bbox="359 134 568 165" type="text" value="192.168.100.100"/>	<p>Static fallback address</p> <p>This is the default backup static IP address “192.168.100.100”. When the DHCP address can not be detected within default seconds, it will change to this IP address automatically.</p>
Static fallback Subnet Mask <input data-bbox="387 400 580 427" type="text" value="255.255.255.0"/>	<p>Static fallback Subnet Mask</p> <p>This is the backup Subnet Mask “255.255.255.0”. When the DHCP mode can not be detected within default seconds, it will change to this Subnet Mask automatically.</p>
HTTP Port <input data-bbox="277 651 387 692" type="text" value="80"/>	<p>HTTP Port</p> <p>This is the HTTP Port and the default port No. is 80.</p>
RTSP Port <input data-bbox="288 863 412 906" type="text" value="554"/>	<p>RTSP Port</p> <p>This is the RTSP Port and the default port No. is 554.</p>
TCP Port <input data-bbox="266 1074 376 1117" type="text" value="5678"/>	<p>TCP Port</p> <p>This is the TCP Port No. and the default port No. is 5678.</p>
UDP Port <input data-bbox="277 1284 400 1327" type="text" value="1259"/>	<p>UDP Port</p> <p>This is the UDP Port No. and the default port No. is 1259.</p>

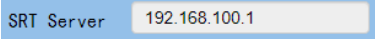
Items	Descriptions
 <p>Sony Visca 52381</p>	<p>Sony Visca This is the Sony Visca Port No. and the default No. is 52381.</p>
 <p>First Stream <input type="radio"/> On <input checked="" type="radio"/> Off <input type="checkbox"/> Video <input type="checkbox"/> Audio MRL <input type="text" value="rtmp://192.168.100.138/live/stream0"/></p>	<p>First Stream This option allows users to determine whether they want to turn on/turn off the First Stream streaming. Moreover, this option can turn on/turn off the streaming of video and audio separately.</p> <p>MRL Please copy the RTMP server address and streaming key from the streaming platform and then paste them into this MRL column. After that, please press the “Apply” button for starting the streaming successfully.</p>
 <p>Second Stream <input type="radio"/> On <input checked="" type="radio"/> Off <input type="checkbox"/> Video <input type="checkbox"/> Audio MRL <input type="text" value="rtmp://192.168.100.138/live/stream1"/></p>	<p>Second Stream This option allows users to determine whether they want to turn on/turn off the Second Stream streaming. Moreover, this option can turn on/turn off the streaming of video and audio separately.</p> <p>MRL Please copy the RTMP server address and streaming key from the streaming platform and then paste them into this MRL column. After that, please press the “Apply” button for starting</p>

Items	Descriptions
	the streaming successfully.
	<p>SRT On/Off This allows users to turn on or turn off the SRT streaming function.</p>
	<p>SRT Mode When the SRT ON/OFF is turned on, you can select “Caller” or “Listener” mode from this drop-down menu.</p>
	<p>SRT Server This SRT server provides an IP address for you to enter into your SRT streaming software when you are using the SRT streaming function and the PTC-285NDI camera is set as Listener mode and the SRT streaming software such as the Vmix is set as the Caller mode.</p>
	<p>SRT Port This is the SRT port and the default port No. is 4578.</p>

Items	Descriptions
<div style="border: 1px solid #ccc; padding: 5px;"> <div style="display: flex; justify-content: space-between; border-bottom: 1px solid #ccc; margin-bottom: 5px;"> SRT Encryption None ▾ </div> <div style="display: flex; justify-content: space-between; border-bottom: 1px solid #ccc; margin-bottom: 5px;"> SRT Password None </div> <div style="display: flex; justify-content: space-between;"> Bandwidth Overhead AES-128 AES-192 AES-256 </div> </div>	<p>SRT Encryption</p> <p>When the SRT function is turned on, this option allows users to select their desired SRT Encryption way. There are three encryption ways including AES-128, AES-192 and AES-256 for users to select.</p>
<div style="border: 1px solid #ccc; padding: 5px;"> <div style="display: flex; justify-content: space-between; border-bottom: 1px solid #ccc;"> SRT Password 1234567890 </div> </div>	<p>SRT Password</p> <p>When the SRT encryption way is set, it is needed for users to use this password. The default value is 1234567890 and this password can change by users.</p>
<div style="border: 1px solid #ccc; padding: 5px;"> <div style="display: flex; justify-content: space-between; border-bottom: 1px solid #ccc;"> SRT Bandwidth Overhead 25 </div> </div>	<p>SRT Bandwidth Overhead</p> <p>The Bandwidth Overhead is a percentage which is set according to the network link. You can multiply this percentage value by the encoder-encoded video and audio total bitrates to get the maximum overhead which is allowed by the Bandwidth overhead. This value plus the total value of the video and audio bitrates is the maximum value of the current SRT transmission bandwidth, which is the maximum bandwidth of this SRT channel. The purpose of the bandwidth overhead is to transfer the control message data packet which accompany the SRT streaming. Moreover, it also includes the retransmission for all of the media packets. If the network link condition is worse,</p>

Items	Descriptions
	<p>more exchanges for the control message data packets and more retransmissions for the media data packets will be needed. And you need to set a higher Bandwidth Overhead value.</p>
<p>SRT Variable Latency <input type="text" value="120"/></p>	<p>SRT Variable Latency This column allows you to set the transmission latency of the SRT streaming. You can set the latency within the range of 20 to 8000.</p>
<p>SRT StreamId <input type="text" value="#!::u=admin"/></p>	<p>SRT Stream ID This option allows you to turn on or turn off the SRT Stream ID. The Stream ID is an information which can be exchanged between the SRT Caller and the SRT Listener when the SRT connection is established. This Stream ID information allows the SRT Listener to determine whether the connection from a certain SRT Caller should be accepted or not.</p>
<p>RTSP Auth <input type="radio"/> On <input checked="" type="radio"/> Off</p>	<p>RTSP Auth This option allows users to turn on or turn off the authentication of the RTSP streaming.</p>
<p>ONVIF <input type="radio"/> On <input checked="" type="radio"/> Off</p>	<p>ONVIF This option allows users to turn on or turn off the ONVIF function.</p>

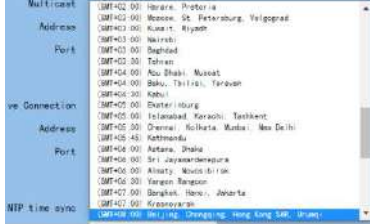
Items	Descriptions
<p>ONVIF Auth <input type="radio"/> On <input checked="" type="radio"/> Off</p>	<p>ONVIF Auth This option allows users to turn on or turn off the ONVIF authentication.</p>
<p>Multicast <input checked="" type="radio"/> On <input type="radio"/> Off</p>	<p>Multicast This option allows users to turn on or turn off the Multicast function.</p>
<p>Address <input type="text" value="224.1.2.3"/></p>	<p>Address This option is the address of Multicast. The default value is 224.1.2.3</p>
<p>Port <input type="text" value="6688"/></p>	<p>Port This is the Port No. of the Multicast. The default No. is 6688.</p>
<p>NTP time sync <input checked="" type="radio"/> On <input type="radio"/> Off</p>	<p>NTP Time Sync This option allows users to turn on or turn off the NTP Time Sync function.</p>
	<p>Time Zone This option allows users to select their time zone.</p>

Items	Descriptions
Server address <input type="text" value="time.google.com"/>	<p>Server Address</p> <p>This option allows you to set the time calibration server when doing the time calibration and the server can be changed by users.</p>
Time interval (min) <input type="text" value="1440"/>	<p>Time Interval</p> <p>This option allows users to set the time interval for the time calibration.</p>
Main time show <input checked="" type="radio"/> On <input type="radio"/> Off Position <input type="text" value="X"/> <input type="text" value="0"/> <input type="text" value="Y"/> <input type="text" value="0"/>	<p>Main Time Show/Position</p> <p>This option allows users to open or close the time display function for the main time. Moreover, users can enter different X coordinate and Y coordinate positions to determine the position for showing the time on the screen. (The allowable setting range is from 0 to 100).</p>
Sub time show <input type="radio"/> On <input checked="" type="radio"/> Off Position <input type="text" value="X"/> <input type="text" value="0"/> <input type="text" value="Y"/> <input type="text" value="0"/>	<p>Sub Time Show/Position</p> <p>This option allows users to open or close the time display function for the sub time. Moreover, users can enter different X coordinate and Y coordinate positions to determine the position for showing the time on the screen. (The allowable setting range is from 0 to 100).</p>
<input type="button" value="Apply"/>	<p>Apply Key</p> <p>After all of the options are set, please click the “Apply” key and then all of the changes will be effective.</p>

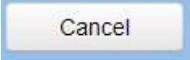
Items	Descriptions
 A rectangular button with a light gray background and a blue border, containing the text "Cancel".	Cancel Key If the “Cancel” key is pressed, all of the changes will not take effect.

9.8 NDI®Config

NDI®Config interface provides you NDI related parameters including “NDI®Local Device Name”, “NDI®Local Device Channel” and “NDI® Receive Group”. You also can turn on or turn off the option for “Enable NDI® Discovery Server” and “Enable NDI® Multicast Server”. Moreover, this interface also provides information such as the address for “NDI® Discovery Server”, “NDI® Multicast Address” and “NDI® Multicast Mask”. For the main interface of the NDI®Config, please refer to the diagram below.

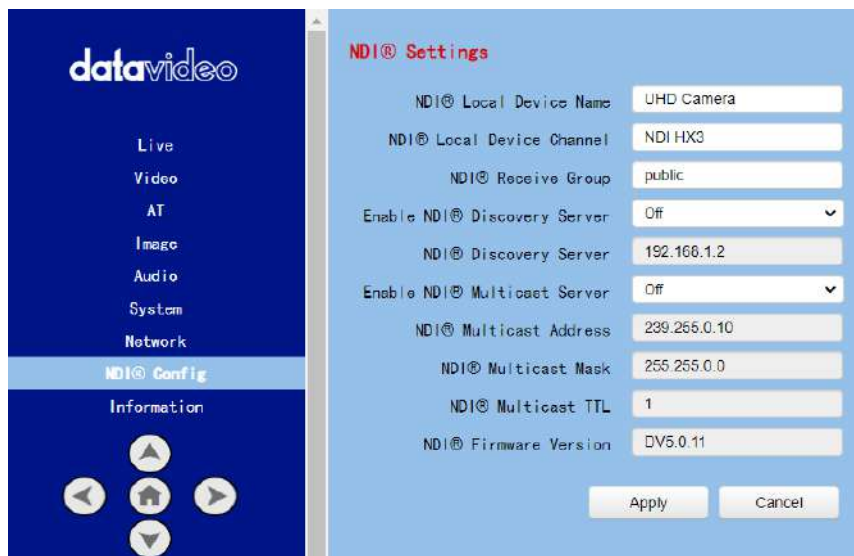

9.9 Information

In the “Information” option, users can change the device name by themselves. Moreover, users can also see the messages including software version and webware version. The main interface of the Information option is shown as following diagram



Please see following section for realizing the descriptions for each item for the information option.



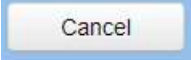



Items	Descriptions
Device ID <input data-bbox="273 692 577 743" type="text" value="UHD Camera"/>	Device ID This column allows users to determine the device ID by themselves. What they have to do is to enter their desired device ID and then click the “Apply” button.
Software Version <input data-bbox="306 927 555 954" type="text" value="SOC v1.1.06 - ARM 7.0.06SD"/>	Software Version This option can show current software version.
Webware Version <input data-bbox="306 1045 561 1072" type="text" value="v1.5.5"/>	Webware Version This is the version of the web-based control UI.
<input data-bbox="135 1254 325 1313" type="button" value="Apply"/>	Apply Key After all of the options are set, please click the “Apply” key and then all of the changes will be effective.

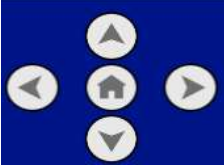

Items	Descriptions
 A rectangular button with a light gray background and a blue border, containing the text "Cancel".	Cancel Key If the "Cancel" key is pressed, all of the changes will not take effect.

9.10 The PTZ Control Area of the Web UI

PTC-285NDI camera's PTZ control area in the Web UI allows users to control the directions, Zoom-In, Zoom-Out, Focus Near and Focus Far parameters for the PTZ camera lens. Moreover, users can also adjust the panning, tilting speed, preset setting and preset calling functions. The PTZ control area is shown as following diagram.

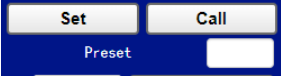

Items	Descriptions
	<p>UP/Down/Left/Right/Home Keys</p> <p>Users can click the up, down, left and right keys and the PTZ camera lens will rotate to assigned direction. If the Home key  is pressed, the camera lens will return back to the initial position automatically.</p> <p>If this Home key is used with the “Back” key, when the “OSD” is selected and the Back key is clicked, the OSD menu will be shown on the external connected screen and users can use the up, down, left and right keys on the Web UI to control the camera.</p>
	<p>Zoom In/Zoom Out/Focus In/Focus Out</p> <p>Click “Zoom In” or “Zoom Out” for zooming in or zooming out the camera lens.</p> <p>Click the “Focus In” or “Focus Out” for Focusing Near or Focusing Far the camera lens.</p>
	<p>Pan Speed</p> <p>The “Pan Speed” allows users to adjust the rotation speed of the PTZ camera lens. The allowable setting range is from 1 to 24. The larger the number, the faster the PTZ camera lens will rotate.</p>
	<p>Tilt Speed</p> <p>The “Tilt Speed” allows users to adjust the vertical rotation speed of the camera lens. The allowable setting range is from 1 to 20. The larger the number, the faster the PTZ camera lens will rotate.</p>
	<p>Zoom Speed</p> <p>The “Zoom Speed” allows users to adjust the Zoom In/Zoom Out speed of the PTZ camera lens. The allowable setting range is from 0 to</p>

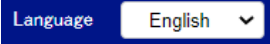
	<p>7. The larger the number, the faster the PTZ camera lens will rotate.</p>
	<p>Focus Speed</p> <p>The “Focus Speed” allows users to adjust the “Focus Near” and “Focus Far” speed of the PTZ camera lens. The allowable setting range is from 0 to 7. The larger the number, the faster the PTZ camera lens will rotate.</p>
	<p>Set and Call Presets</p> <p>The PTC-285NDI provides 255 presets (0-254) for users to set.</p> <p>Users can use “Set” button to set the preset position and users can use the “Call” button to recall the pre-saved presets.</p>
	<p>OSD/PTZ Drop-Down Menu</p> <p>Press the OSD option from the web UI allows camera to call the OSD menu immediately. If the PTZ is selected after the OSD menu is shown, the OSD menu will disappear and the screen will go back to the scene that is shot by the camera.</p>
	<p>Language Drop-Down Menu</p> <p>Users can use this drop-down menu for selecting four different languages including Traditional Chinese, русский, English and Simplified Chinese.</p>

10. How to Use the Web UI to Set and Call Presets

Please follow following steps for setting and recalling the presets.

● How to Set Preset

1. Please adjust your desired camera parameters and camera lens positions in advance.

2. Please enter your desired preset number in the “Preset” column

A screenshot of a web interface showing a dark blue header with the word "Preset" in white text. To the right of the header is a white rectangular input field with a thin blue border.

3. Please click the “Set” button  and then the preset is set successfully.

● How to Recall Preset

1. Please enter the preset number that you want to recall into the “Preset”

A screenshot of a web interface showing a dark blue header with the word "Preset" in white text. To the right of the header is a white rectangular input field with a thin blue border.

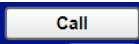
2. Please click the “Call” button  and then the preset is recalled successfully.

11. Quick Setting Area for the Auto-Tracking

The quick setting area of the Auto-Tracking function is located below the PTZ control area for you to turn on or turn off the Auto-Tracking function rapidly. Moreover, it also allows you to select the “Presenter” or “Zone” tracking mode from the drop-down menu. You can also turn on or turn off the “Debug Mode”. If the “Debug Mode” is turned on, there is a green frame that will appear when the Auto-Tracking function is activated. If the “Debug Mode” is turned off, the green frame will not be shown. The interface of the Auto-Tracking quick setting area is shown in the following diagram.

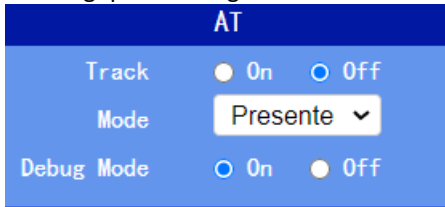

12. Control the Camera by the PTZ View Assist App

Datavideo provides PTZ View Assist App for you to control up to 4 PTC-285NDI cameras by using Android or iOS handset. What you have to do is to set your handset or tablet in the same LAN with the PTZ View Assist App by the static IP address, and then you can control various functions of the camera by the Wi-Fi connection. Please download the PTZ View Assist App for the Android or iOS platform by using the following addresses.

Note: The Datavideo PTZ View Assist App can be operated only in DVIP mode. So, please remember to adjust the PTC-285NDI camera to the DVIP mode before using the Datavideo PTZ View Assist App. Please note that you need to turn off the “Multicast” function from the Web UI to prevent the control issue due to the network congestion.

For the Android device: Please go to “Google Play” and then search for the “PTZ View Assist”. Finally, please download and install it.

For the iOS device: Please go to “App Store” and then search for the “PTZ View Assist”. Finally, please download and install it.

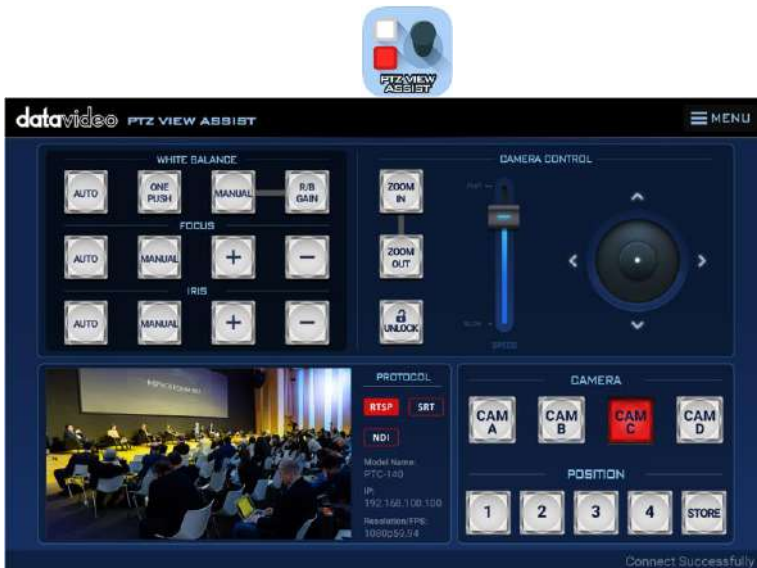

13. DIP Switch Settings

13.1 DIP Switch SW1

The DIP Switch SW1 can be found at the bottom of the camera, where the user is allowed to set the camera's VISCA ID, enable remote control, select the video resolution, and configure how the video mode can be selected.

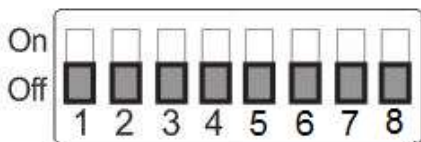

DIP SW 1/2/3	VISCA ID
(1,2,3) = (ON,OFF,OFF)	VISCA-ID 1
(1,2,3) = (OFF,ON ,OFF)	VISCA-ID 2
(1,2,3) = (ON ,ON ,OFF)	VISCA-ID 3
(1,2,3) = (OFF,OFF,ON)	VISCA-ID 4
(1,2,3) = (ON ,OFF,ON)	VISCA-ID 5
(1,2,3) = (OFF,ON ,ON)	VISCA-ID 6
(1,2,3) = (ON ,ON ,ON)	VISCA-ID 7
DIP SW 4	Remote Control Protocol
(4) = (ON or OFF)	System will detect automatically
DIP SW 5/6/7	Resolution
(5,6,7) = (OFF,OFF,OFF)000	1920 x 1080i 59.94
(5,6,7) = (ON,OFF,OFF)100	1920x1080i50
(5,6,7) = (OFF,ON,OFF)010	1920 x 1080p 59.94
(5,6,7) = (ON,ON,OFF)110	1920 x 1080p 50
(5,6,7) = (OFF,OFF,ON)001	3840 x 2160p 29.97
(5,6,7) = (ON,OFF,ON)101	3840 x 2160p 25
(5,6,7) = (OFF,ON,ON)011	3840 x 2160p 59.94
(5,6,7) = (ON,ON,ON)111	3840 x 2160p 50
DIP SW 8	Video Mode Selection Method
ON	Video mode selectable by DIP switch only
OFF	Video mode selectable by menu

13.2 DIP Switch SW2 (IRID)

The IRID DIP Switch can be found on the rear panel of the PTC-285NDI camera. This DIP switch allows the user to assign an ID number to the camera so that the user can navigate between the cameras by pressing the **CAMERA SELECT** buttons.

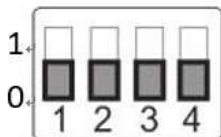

DIP SW 1/2	Camera Select Function (IR Remote Control) – Camera ID Assignment
(1,2) = (0,0)	CAM1 (IR)
(1,2) = (1,0)	CAM2 (IR)
(1,2) = (0,1)	CAM3 (IR)
(1,2) = (1,1)	CAM4 (IR)
* DIP SW 3/4 should be always OFF.	

14. How to Play the RTSP Stream by the VLC Player

Please follow following steps for playing the RTSP streaming by using the VLC Player.

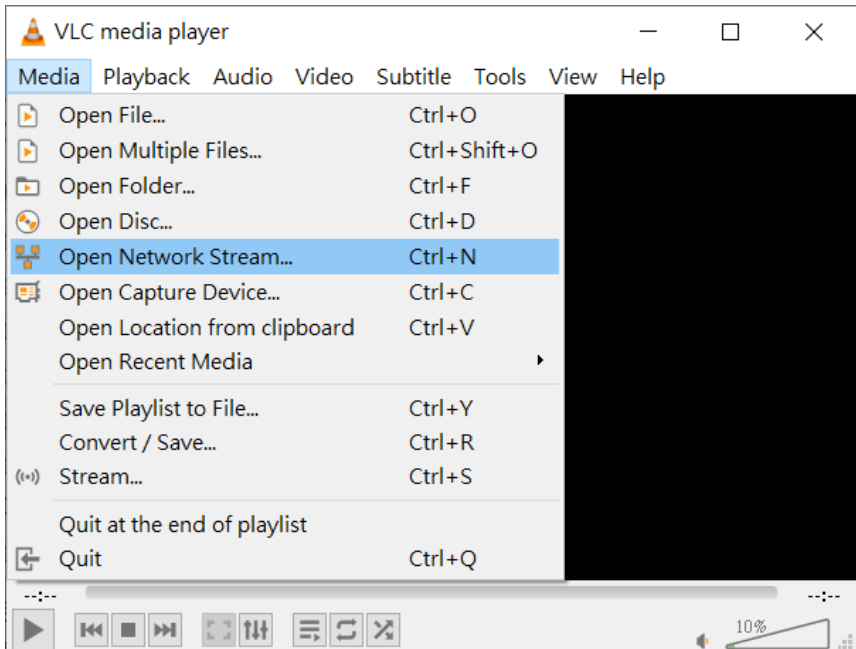

1. Please open the VLC Player.
2. Please click "Media-> Open Network Stream".
3. Please enter the RTSP address.

rtsp://ip address: port No./1 (first stream).

rtsp://ip address: port No./2 (second stream).

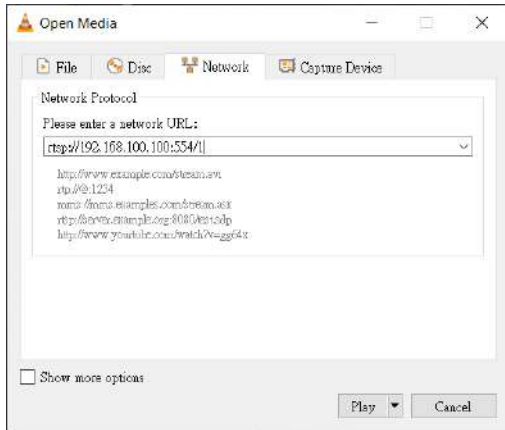

4. Please click “Play” button.

Note: The default port No. of the RTSP is 554, if the default http port of the camera is 80, it is no need for users to enter the port No.

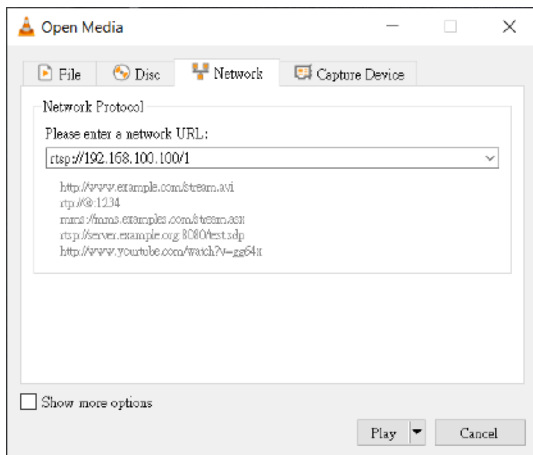

15. How to Play the Multicast by the VCL Player

The RTP Multicast allows users to view the camera image remotely by specific video player such as the VLC Player.

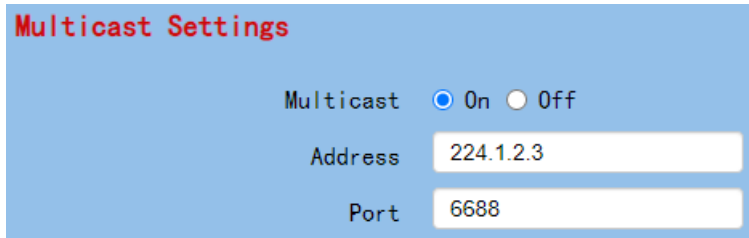

Please follow following steps for playing the RTP Multicast in the VLC Player.

1. Download VLC media player from the link <https://www.videolan.org>.
2. Open VLC, click “Media” → “Open Network Stream” then enter **rtp://224.1.2.3:6688** to view the video streaming.

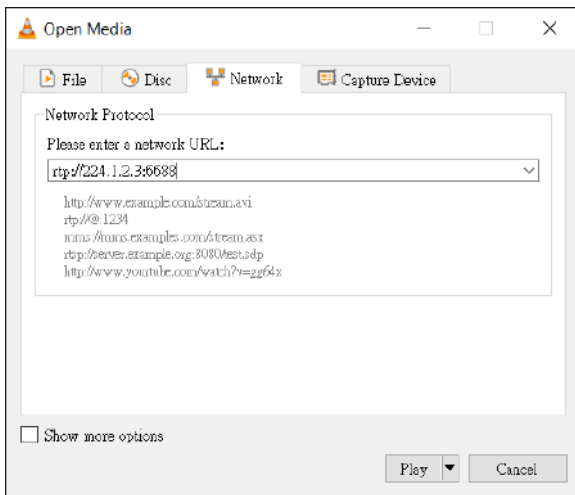

3. Click the “Play” button to start viewing the video stream.

16. How to Stream to Facebook

Please follow following steps for streaming to Facebook Streaming platform.

- **Use Facebook Live Producer for Streaming**

1. Please go to Facebook Live website

<https://www.facebook.com/formedia/solutions/facebook-live> , and then

please click “Go Live Now” button which is shown in the following diagram.

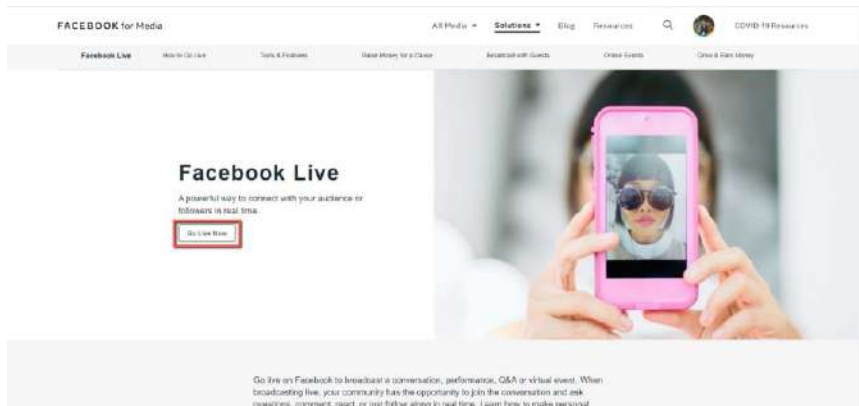

Note: Facebook Live limits each stream to 8 hours.

2. Please click the “Select” button from the “Go live” option which is shown in the following diagram.

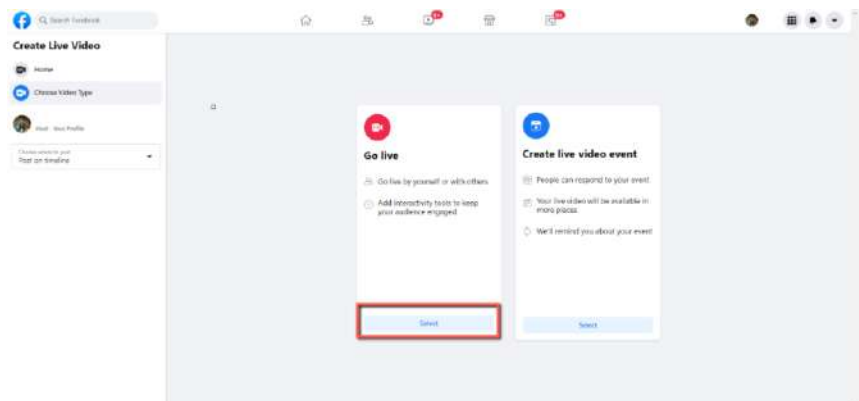

3. Please select the “Streaming Software” option, and then please enter the title and description of your live-streaming video in the “Title” and “Description” columns. Moreover, you can determine whether you want to share your live-streaming video to your Facebook Story.

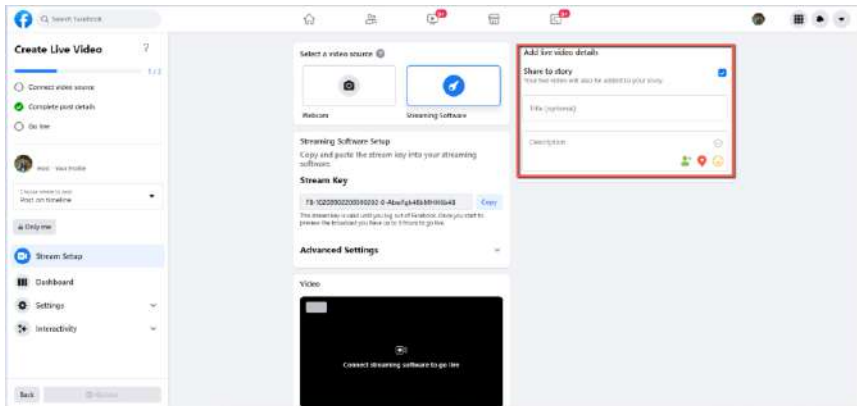

4. Please select “Advanced Settings”, and then you can see the “Server URL”. You need the “Server URL” and the “Stream Key” which are on the page for live-streaming videos on the Facebook page.

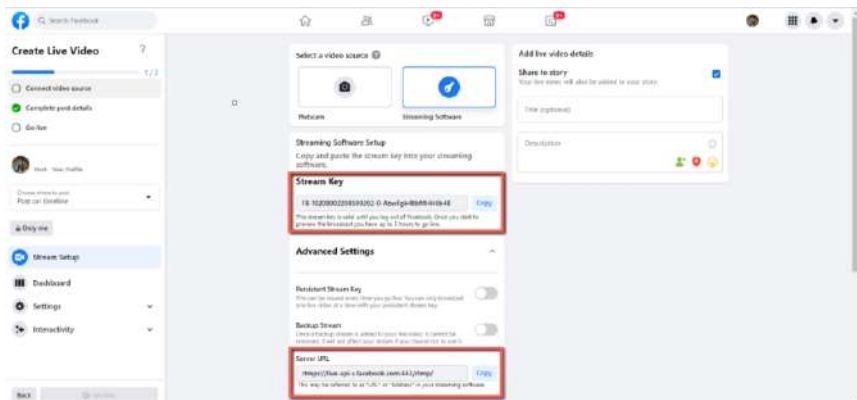

5. Please click the “Copy” buttons which are located next to the “Server URL” and “Stream Key” columns respectively. After that, please paste them to the “First Stream MRL” column in the “Network” option of the PTC-285NDI web UI.

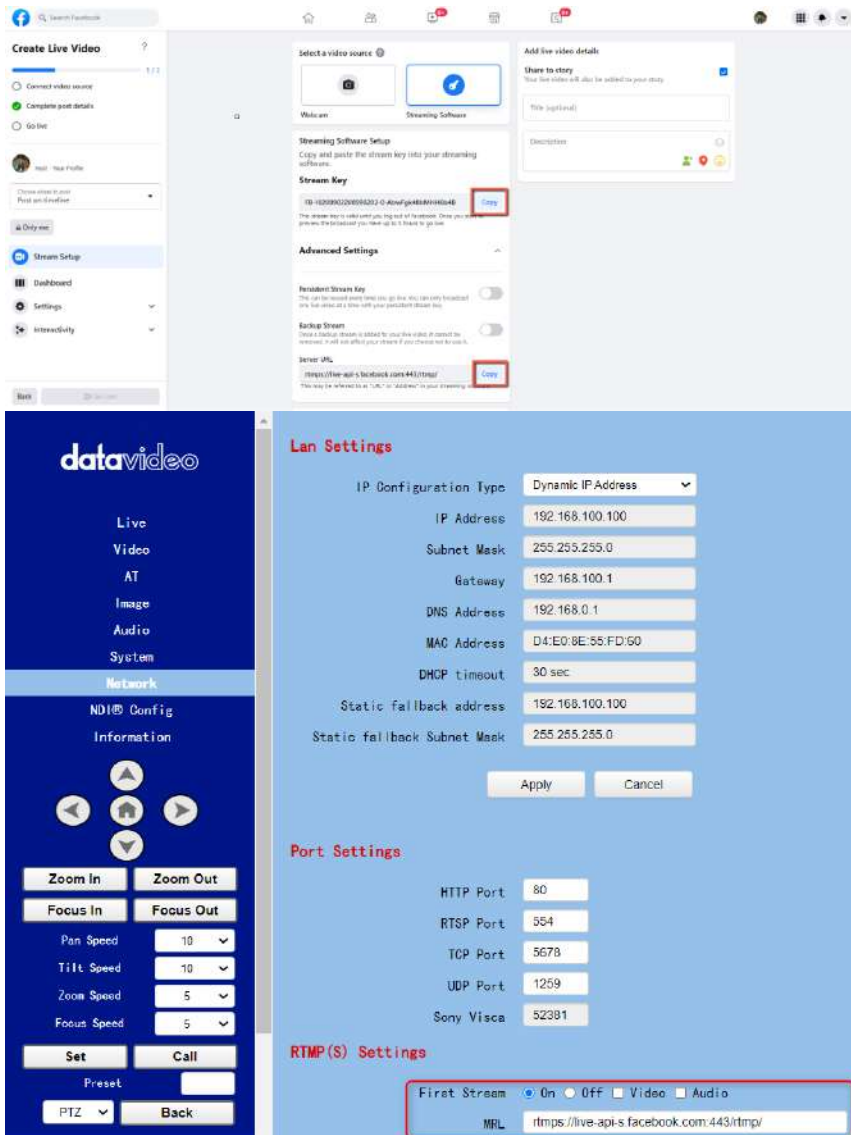

Note: Please make sure that the “ON” is selected for the First Stream MRL . Moreover, please make sure that the “Video” and “Audio” checkboxes are checked.

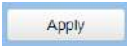
6. Please click the “Apply” button 

7. Please click the “Reboot” button in the “System” option to reboot the PTC-285NDI.

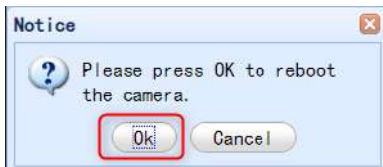

8. After the PTC-285NDI is rebooted, you can see the real-time preview which is shot by the PTC-285NDI camera from the “Video” option of the Facebook Live page.

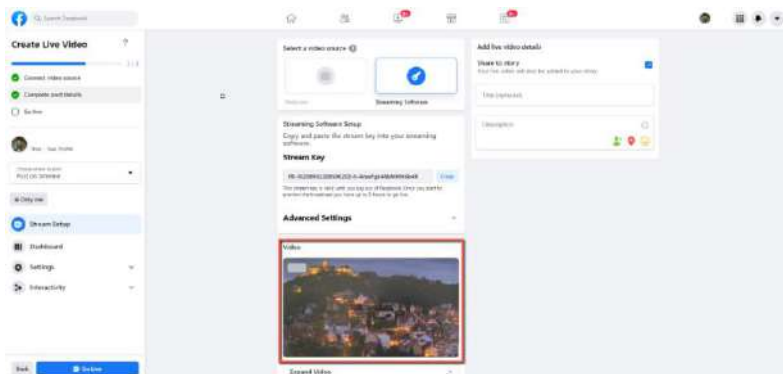

9. Please set related settings including “Choose where to post” and “Select audience”. After that, please press the “Go Live” button for live-streaming the real-time image which is shot by the PTC-285NDI immediately.

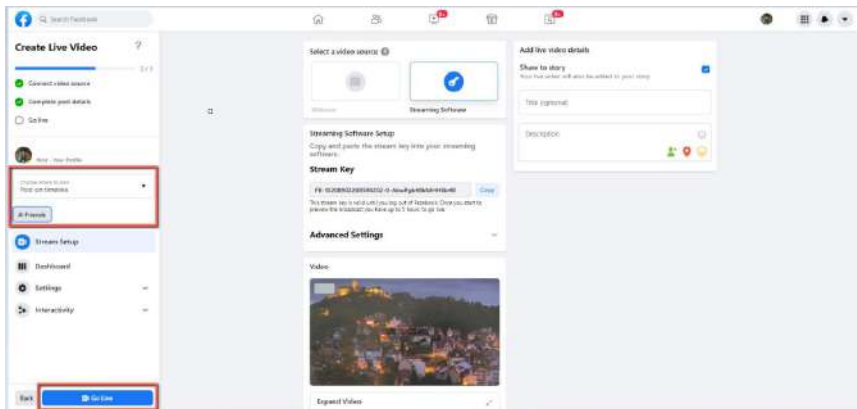
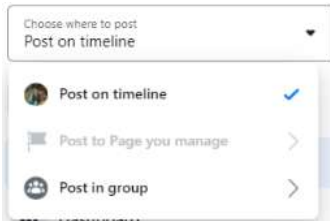

10. And then you can see that the live-streaming is done successfully. If you want to stop the live-streaming, please click the “End Live Video” button for stopping the live-streaming immediately.

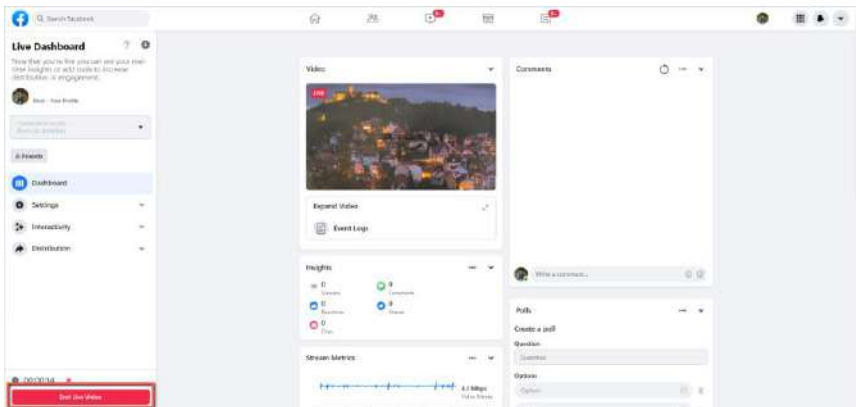

- **Use the Personal Facebook Page or the Facebook Fan Page for Streaming**

1. Please click “Live Video” from your Facebook Personal Page or Facebook Fan Page.



2. Please click the “Select” button from the “Go live” option which is shown in the following diagram.

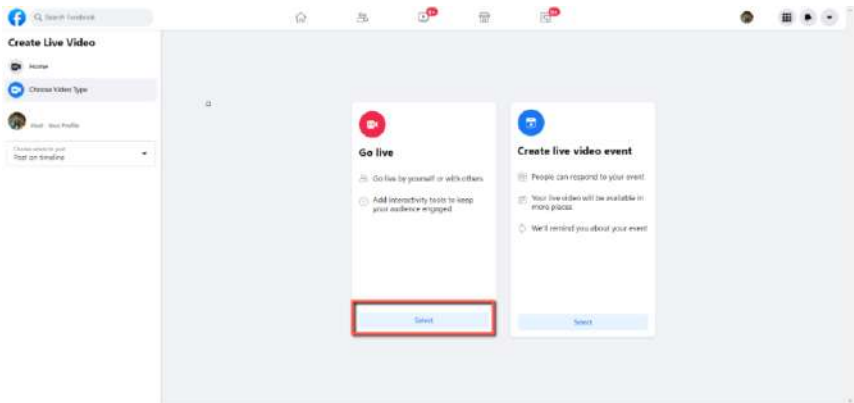

3. Please select the “Streaming Software” option, and then please enter the title and description of your live-streaming video in the “Title” and “Description” columns. Moreover, you can determine whether you want to share your live-streaming video to your Facebook Story.

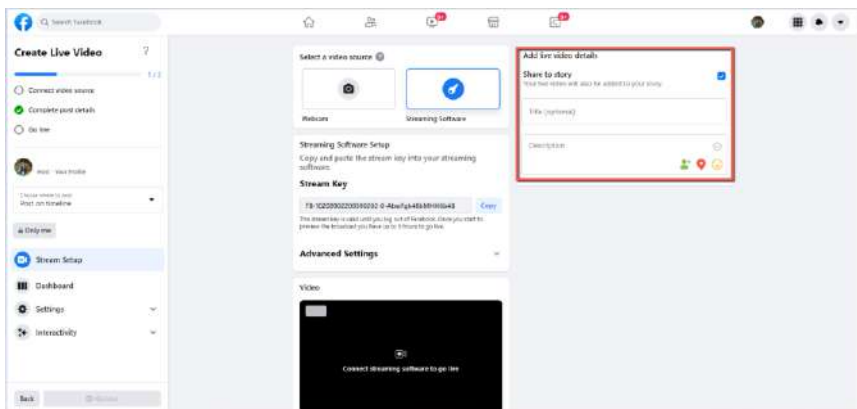

4. Please select “Advanced Settings”, and then you can see the “Server URL”. You need the “Server URL” and the “Stream Key” which are on the page for live-streaming videos on the Facebook page.

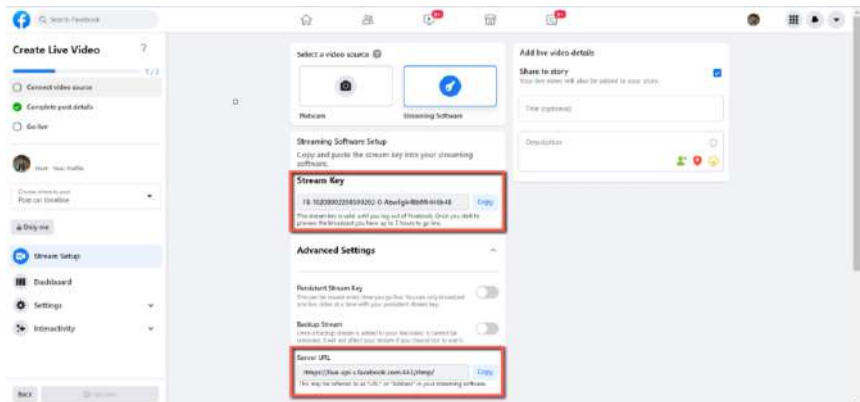

5. Please click the “Copy” buttons which are located next to the “Server URL” and “Stream Key” columns respectively. After that, please paste them to the “First Stream MRL” column in the “Network” option of the PTC-285NDI web UI.

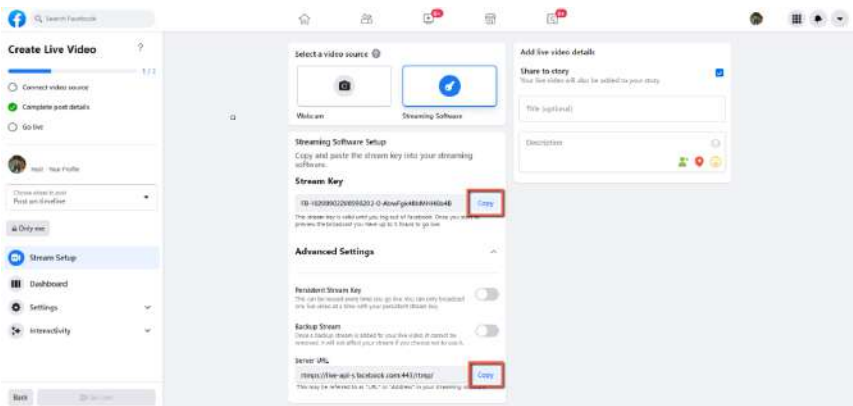



Note: Please make sure that the “ON” is selected for the First Stream MRL . Moreover, please make sure that the ”Video” and ”Audio” checkboxes are checked.

6. Please click the “Apply” button .

7. Please click the “Reboot” button in the “System” option to reboot the PTC-285NDI.

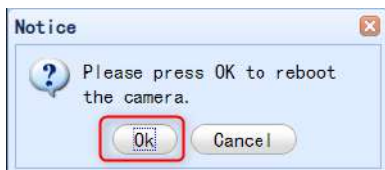

8. After the PTC-285NDI is rebooted, you can see the real-time preview which is shot by the PTC-285NDI camera from the “Video” option of the Facebook Live page.

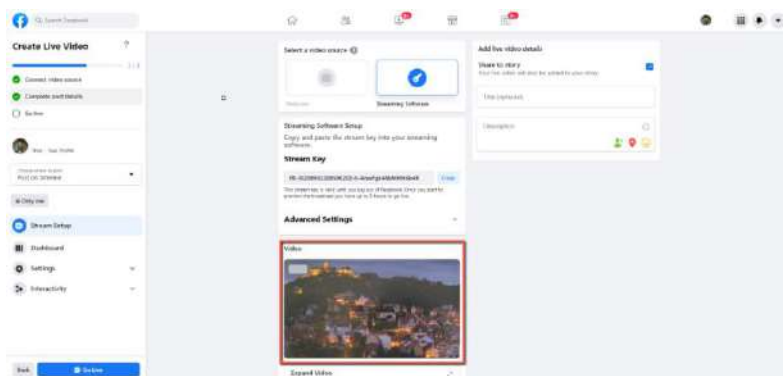

9. Please set related settings including “Choose where to post” and “Select audience”. After that, please press the “Go Live” button for live-streaming the real-time image which is shot by the PTC-285NDI immediately.

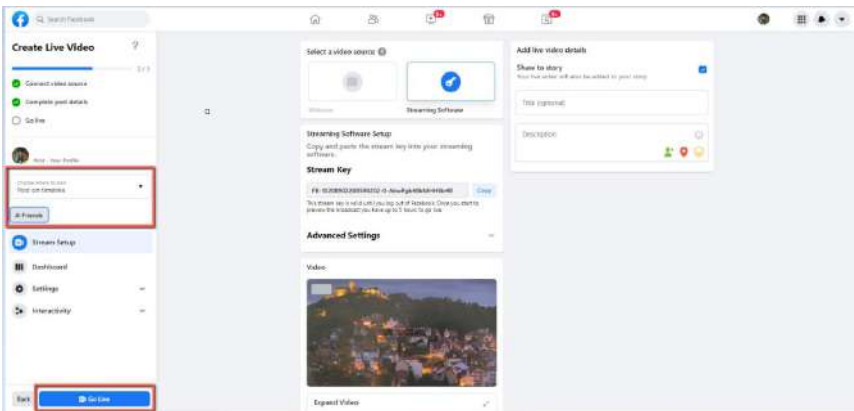
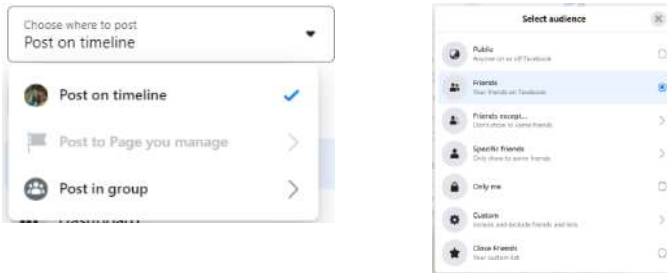

10. And then you can see that the live-streaming is done successfully. If you want to stop the live-streaming, please click the “End Live Video” button for stopping the live-streaming immediately.

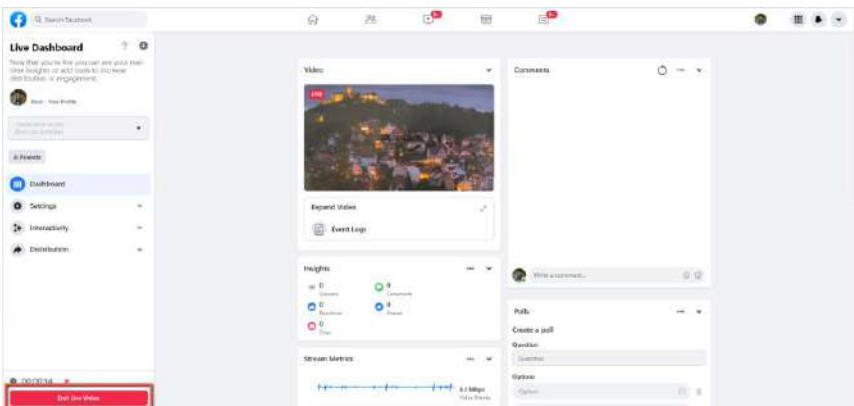

17. How to Stream to Youtube

Please see following steps for realizing how to stream to Youtube streaming platform.

1. Please go to Youtube website www.youtube.com and then click “Create->Go Live”.

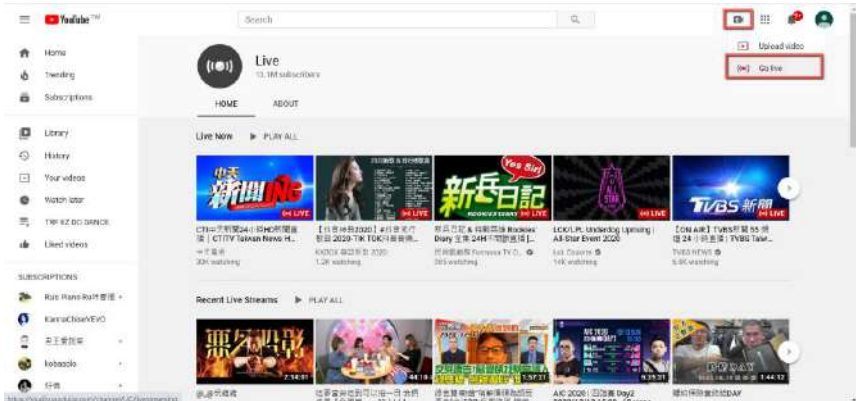

2. Users will enter “Youtube Live Control Room” page, please click the “START” button from the “Right Now” option.

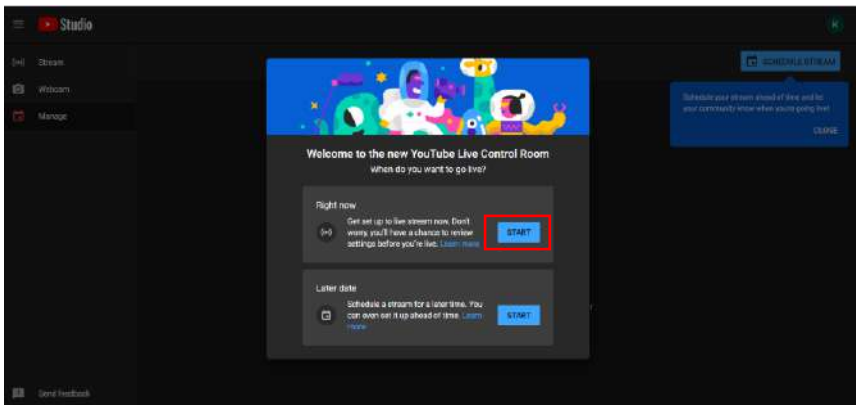

3. Please click **“Go”** button from the **“Streaming Software”** option.

4. Users will see the main page of the **“Youtube Studio”**. Please click the **“EDIT”** button for setting detail information of your streaming activity. After you finish filling out those information, please click the **“SAVE”** button.

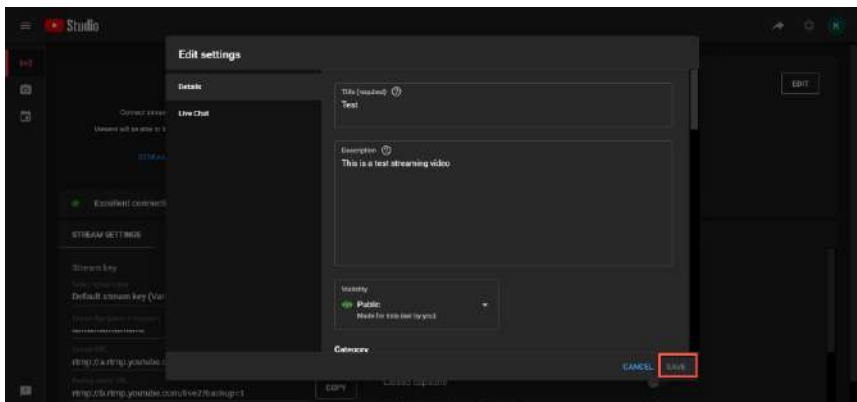
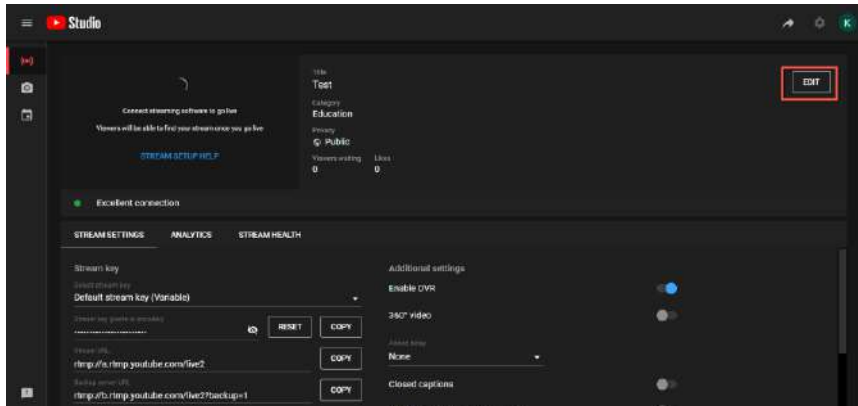

5. Users can see the Stream Key and Stream URL that are provided by the Youtube streaming platform. Please copy the stream key and stream URL and then paste them into the “**First Stream MRL**” within the “**Network**” option of the PTC-285NDI Web UI. Please click “**On**” and please check the checkboxes of “**Audio**” and “**Video**”.

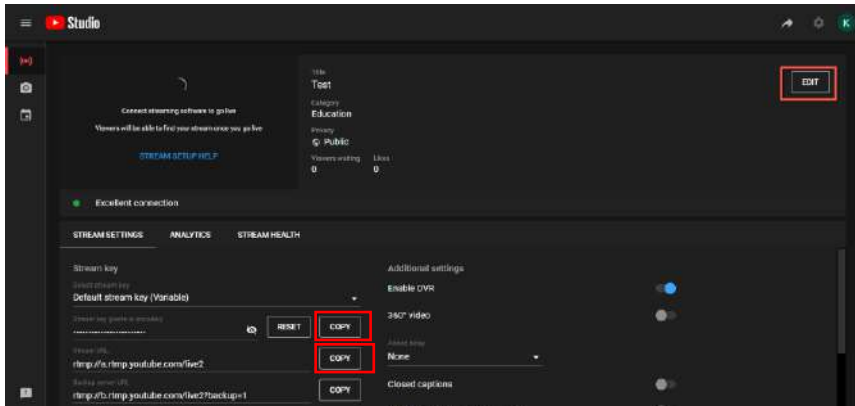

6. Please click the “Apply” button.

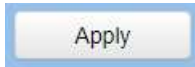

7. Please reboot the PTC-285NDI camera and then users can see the streaming is started on the Youtube Live page. If you want to stop the live streaming, please click the “END STREAM” button for stopping the live streaming.

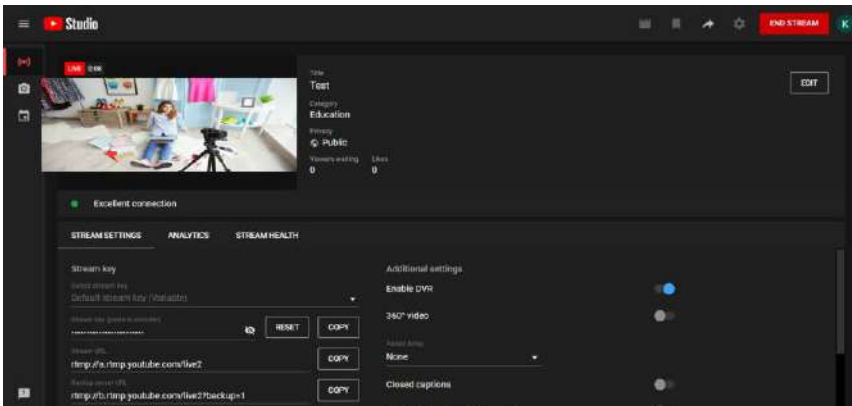

18. How to do the SRT Streaming by the vMix Software

How to install the Vmix Software

Please install the vMix software according to following steps.

1. At first, please go to vMix official website and then download the vMix 60-day free-trial. This section will use vMix free-trial as an example to demonstrate the operation steps. Please click the “DOWNLOAD FREE TRIAL”



button for downloading.

2. Please double-click the vmix23.exe  vmix23 .

3. Please click the “Next” button.

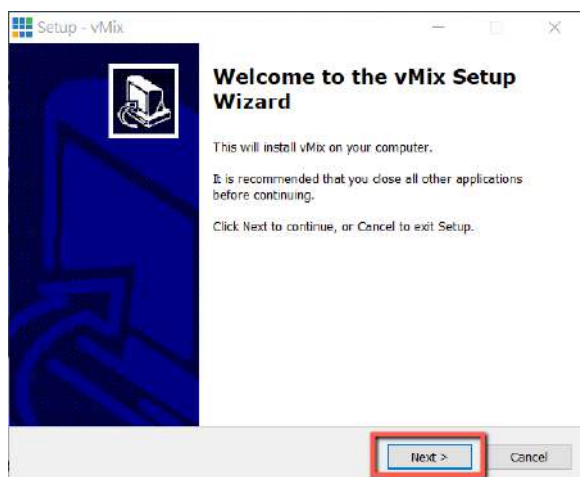

4. Please click “I accept the agreement” and then click the “Next” button.

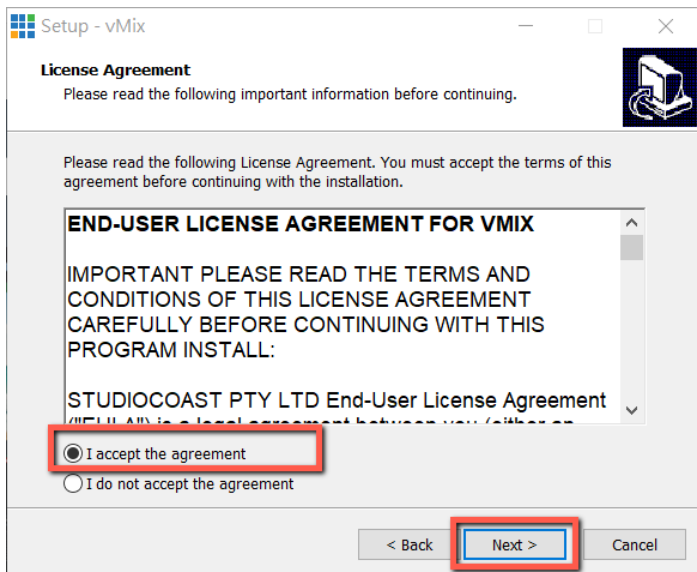

5. Please click the “Next” button.

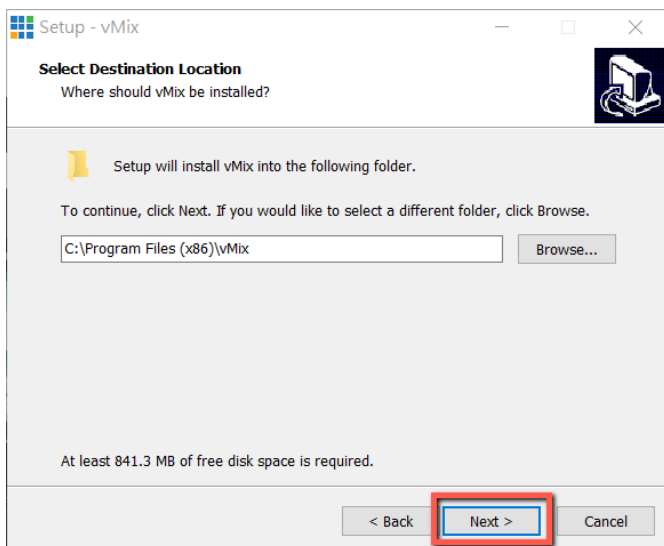

6. Please click the “Next” button.

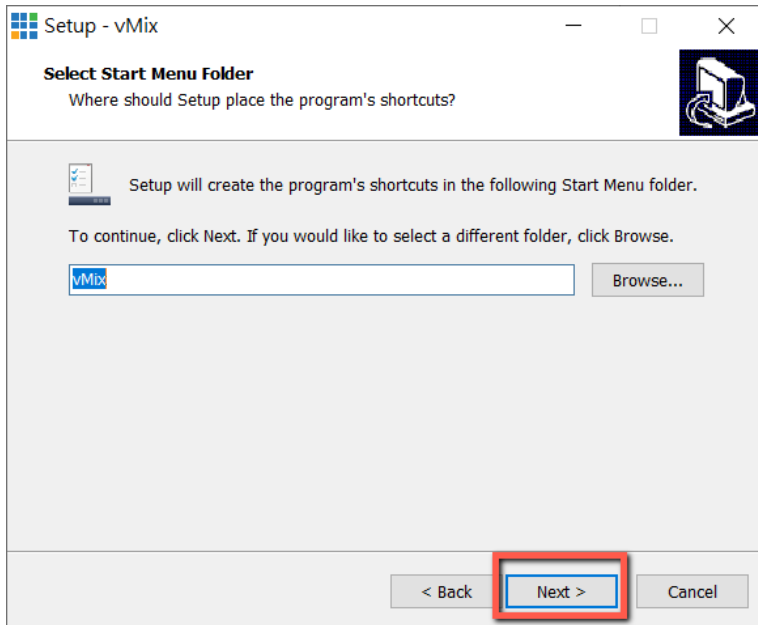

7. Please click the “Next” button.

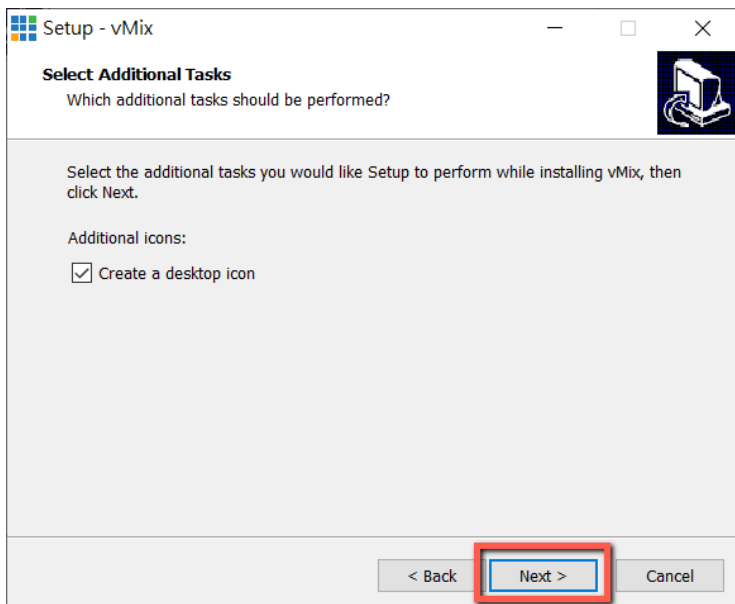

8. Please click the “Install” button.

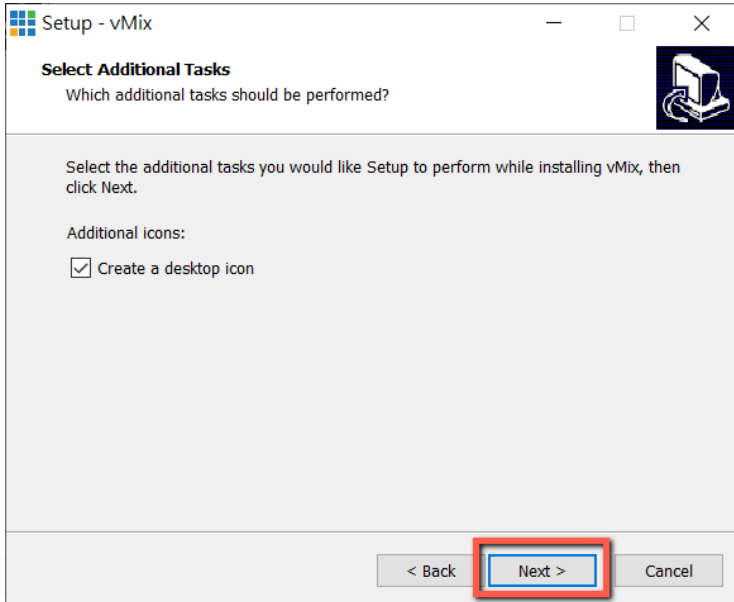

9. The installation will be started.

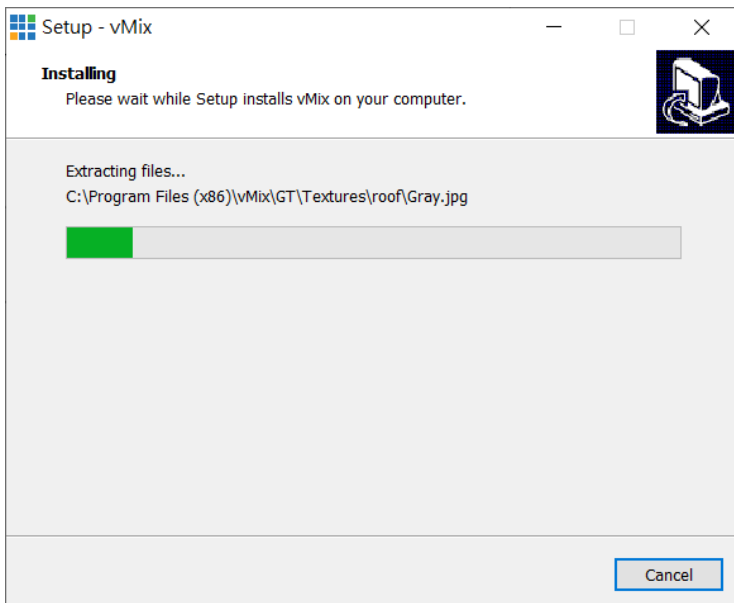

10. Please click the “Finish” button to finish the installation.

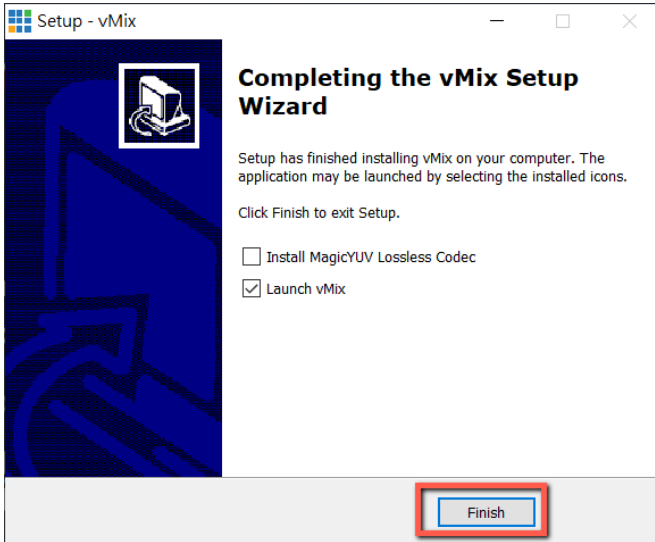

11. Please select “Register for a fully functional 60 Day Trial” to fill out your Email Address. After that, please click the “OK” button to open the vMix software.

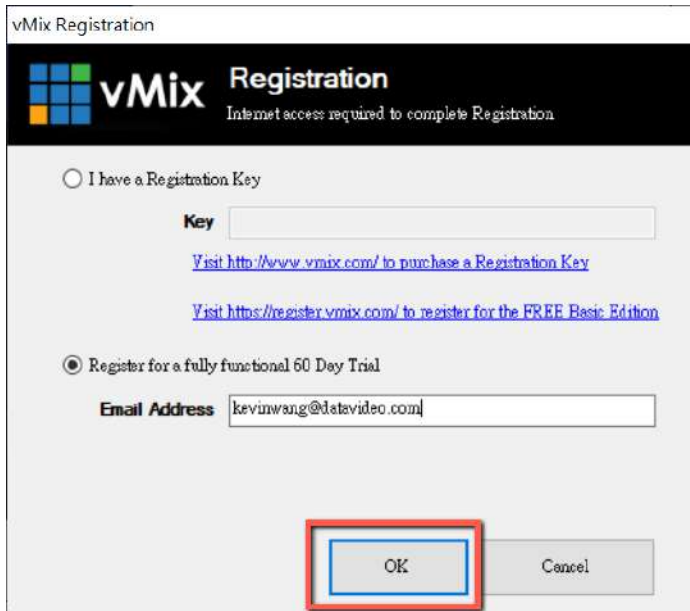

12. Please select the initial resolution and frame rate that you want to use and then please click the “OK” button.

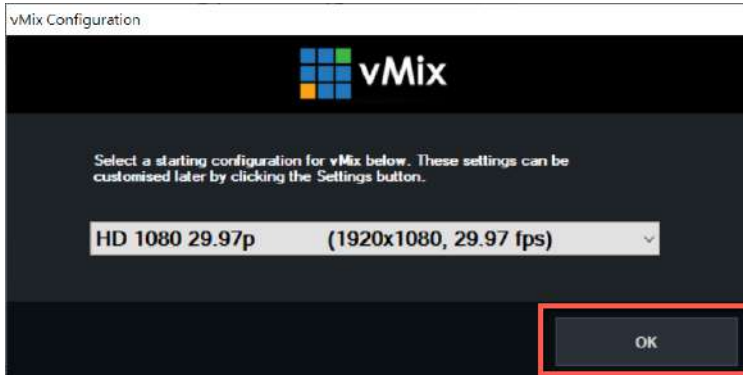

13. After opening vMix, the software interface is shown as following diagram.

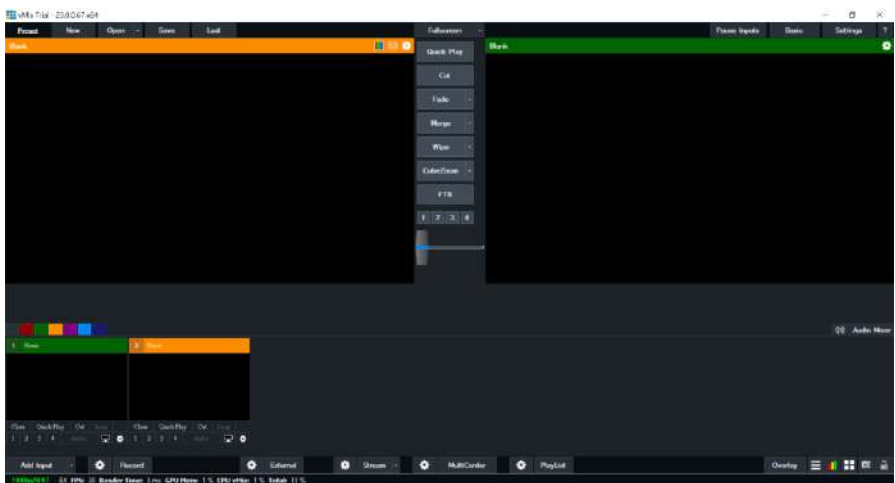

How to do the SRT Stream by Using the PTC-285NDI Camera and vMix Software

There are two modes for the SRT streaming including the Caller Mode and the Listener Mode. Please see following steps for realizing operation steps for the vMix.

If the PTC-285NDI is set in Listener Mode

1. At first, please click the “vMix(x64)” from the Start Menu to open the Vmix software.

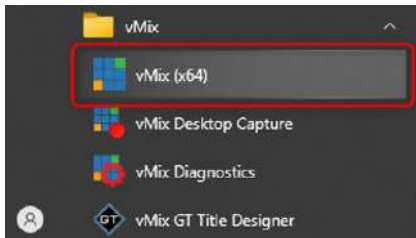

2. After that, you will see the Vmix main interface which is shown in the following diagram.

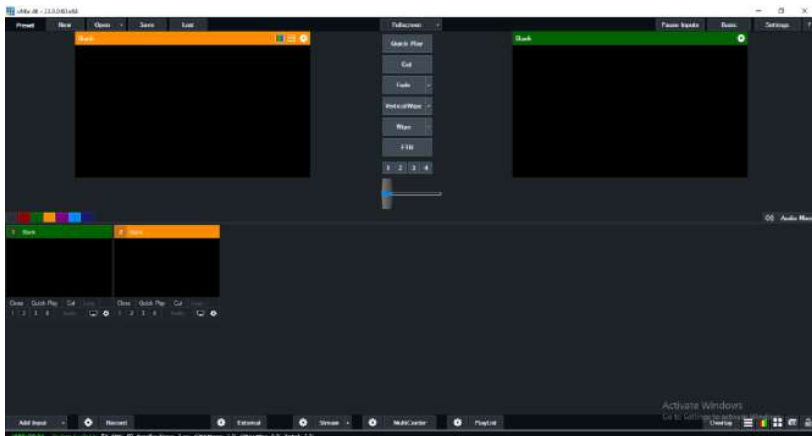

3. Please go back to the PTC-285NDI interface to make sure that the “SRT” option in the SRT Settings is “ON”. Moreover, the default value of the “SRT Port” is “4578”. The “SRT Encryption” drop-down menu allows you to select your desired SRT Encryption way including AES-128, AES-192 and AES-256. The default value of the “SRT Encryption” option is “Off”. In this section, we will take AES-256 as an example. If you need to set an SRT password, please enter your desired SRT password in the “SRT Password” column, it needs a 10-digit or above number. The default SRT Password is “1234567890”. After the setting for the SRT Password is finished, please press the “Apply” button which is located on the bottom side of the Web UI to apply the new setting.

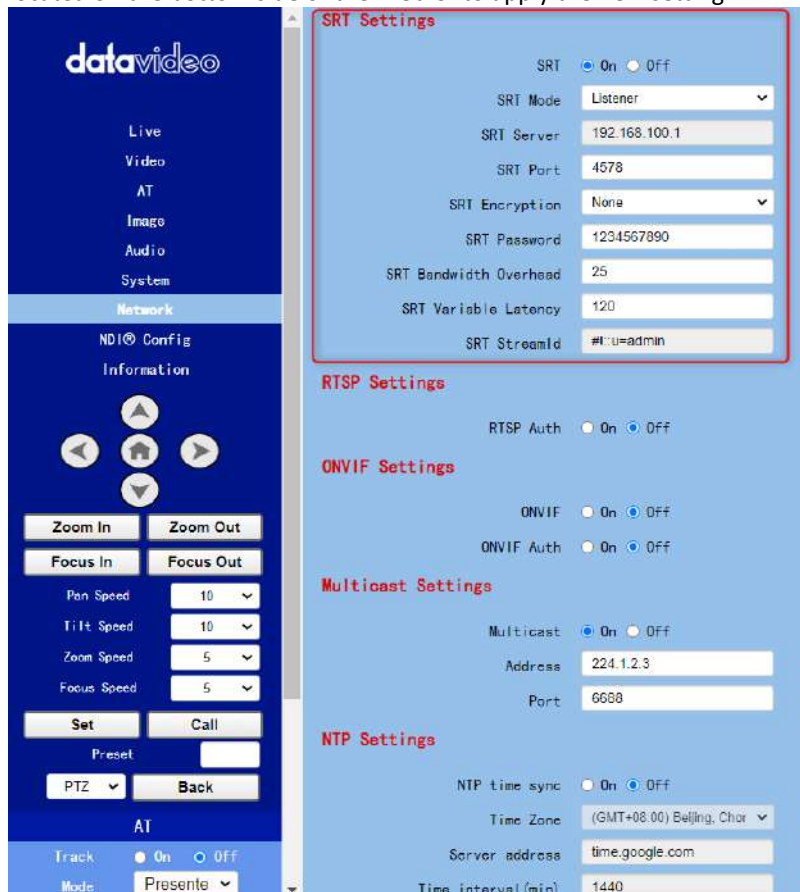

4. Please go back to the main interface of the Vmxi software and then press the “Add Input” button. After that, please select the “More” option from the drop-up menu.

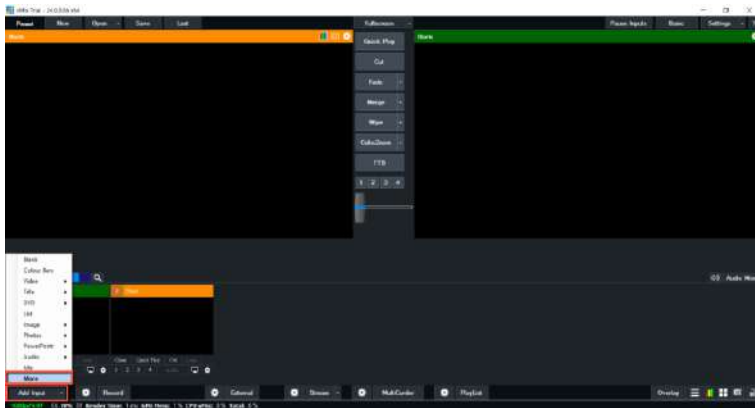

5. After the “Input Select” option is opened, please select the “Stream/SRT” option and then you can see the “Stream/SRT” interface which is shown in the following diagram.

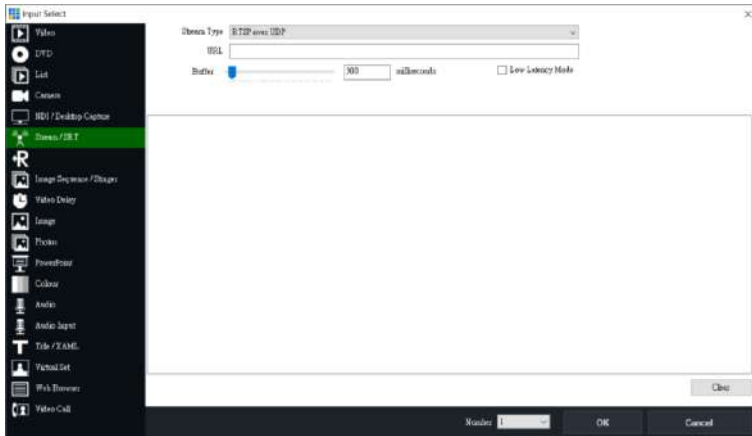

6. Please select the “SRT Caller” option from the “Stream Type” drop-down menu. After that, please enter the default static IP address “192.168.100.100” of the PTC-285NDI into the “Hostname” column. Moreover, please enter the default SRT port number “4578”, which is provided by PTC-285NDI web UI’s “SRT Port” column into the “Port” column. After that, please enter your SRT

Password which is set in the PTC-285NDI web UI into the “Passphrase” column. The default password is “1234567890”. For the “Key Length”, please select “32” from the drop-down menu. After all of the values are entered, please press the “OK” button.

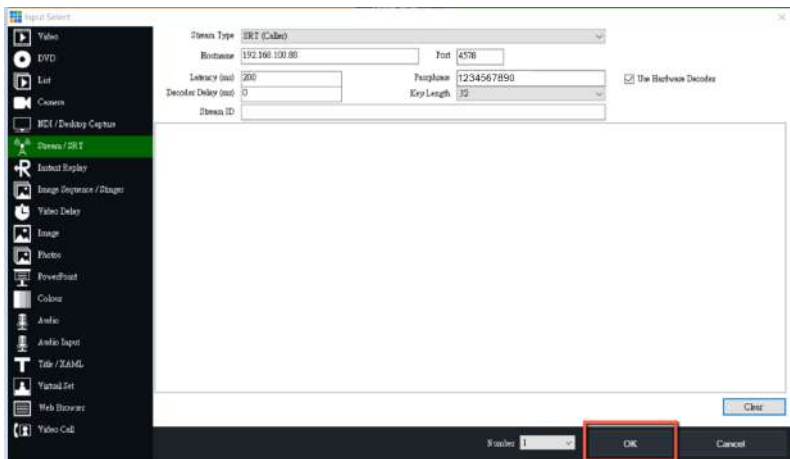

7. After that, you can see that the image which is shot by the PTC-285NDI is streamed to the vMix software by the SRT Listener Mode successfully.

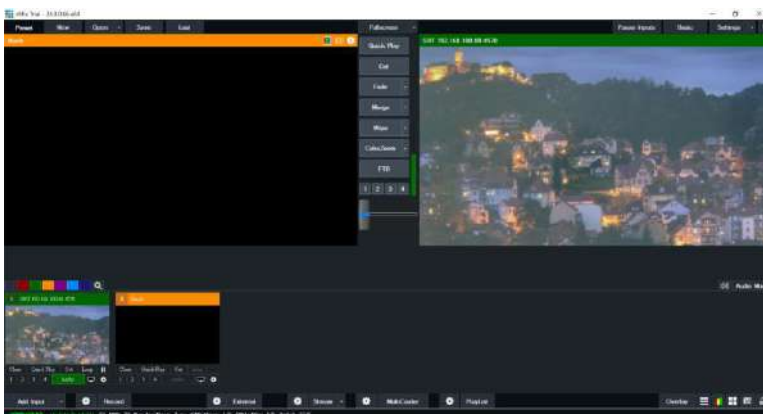

If the PTC-285NDI is set in Caller Mode

1. At first, please click the “Vmix(x64)” from the Start Menu to open the Vmix software.



2. After that, you will see the Vmix main interface which is shown in the following diagram.

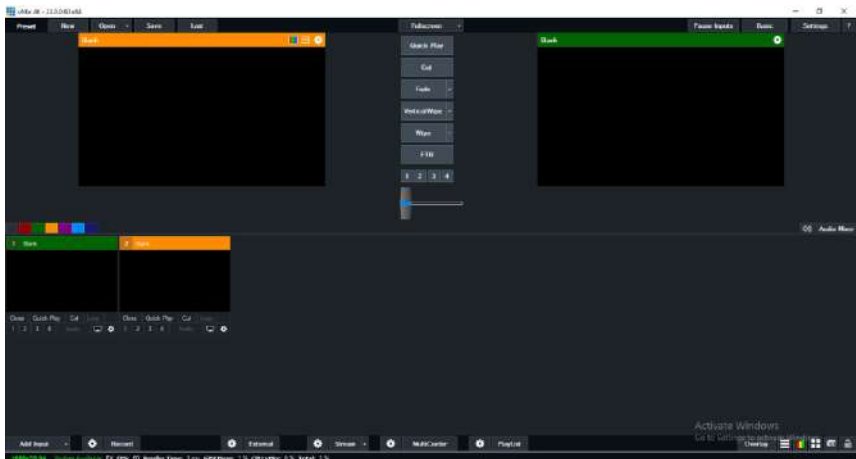

3. At first, please go back to the PTC-285NDI web UI and then please click “ON” from the “SRT” option.



4. Please select “Caller” from the “SRT Mode” drop-down menu.



5. Please enter the static IP address of your device which is used to install the vmix software. In this example, it is the static IP address “192.168.100.30” of the PC which is used to install the Vmix software. Please pay attention that

the static IP address of the device must be within the same LAN as the static IP address of the PTC-285NDI.

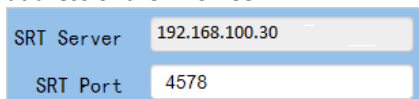

A screenshot of a configuration interface showing two input fields. The first field is labeled "SRT Server" and contains the value "192.168.100.30". The second field is labeled "SRT Port" and contains the value "4578".

6. The SRT port is “4578”, which is the default SRT port number of the PTC-285NDI.

7. Please select your desired SRT Encryption way from the “SRT Encryption” drop-down menu. In this example, we will take the AES-256 as an example.

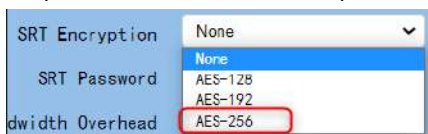

A screenshot of a configuration interface showing a dropdown menu for "SRT Encryption". The menu is open, showing options: "None", "AES-128", "AES-192", and "AES-256". The "AES-256" option is highlighted with a red box. Below the dropdown, the "SRT Password" field is visible but empty, and the "Bandwidth Overhead" field is also visible but empty.

8. Please enter your desired SRT password in the “SRT Password” option. Please pay attention that the password must be a 10-digit or above number. In this example, we will take “1234567890” as an example.

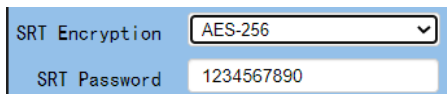

A screenshot of a configuration interface showing two input fields. The first field is labeled "SRT Encryption" and contains the value "AES-256". The second field is labeled "SRT Password" and contains the value "1234567890".

9. Please press the “Apply” button.

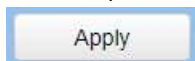

A screenshot of a button labeled "Apply".

10. Please press the “Reboot” button from “System-> Reboot” from the PTC-285NDI web UI.

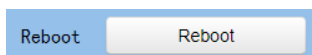

A screenshot of a button labeled "Reboot".

11. Please go back to the Vmix interface, press the “More” option by pressing the “Add Input” option. After that, please select the “Stream/SRT” option. Please select “SRT Listener” from the “SRT Type” option. After that, please enter the default port number “4578” which is provided by the PTC-285NDI web UI into the “Port” column. Moreover, please enter your SRT password which is set in the PTC-285NDI web UI into the “Passphrase” column. In this example, we will take “1234567890” as an example. After that, please select “32” from the “Key Length” drop-down menu. If you have an SRT Stream ID which is provided by your cloud streaming platform, please enter your SRT

Stream ID in the “Stream ID” column. After all of them are entered, please press the “OK” button.

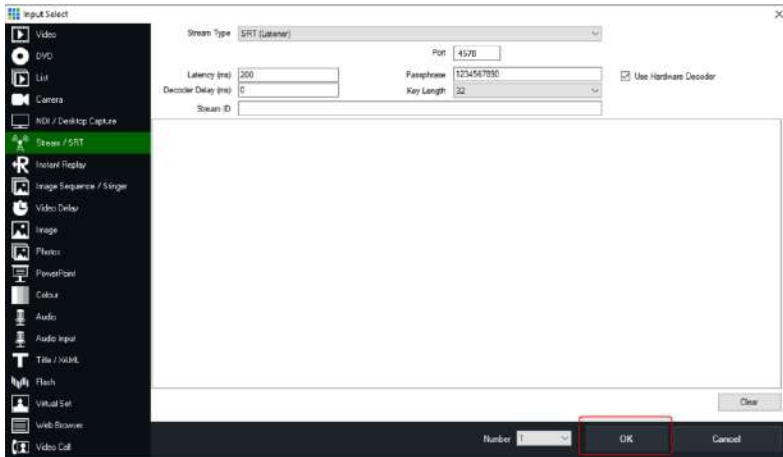

12. You can see that the image which is shot by the PTC-285NDI is shown in the Vmix software by Caller Mode.

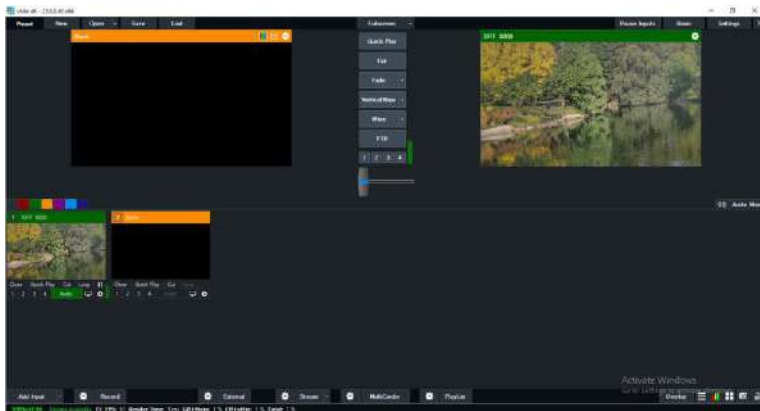

19. Remote Control Port Pinouts

In addition to using the Ethernet port for remote control, you can also connect your PC or any keyboard controllers to the RS-422 remote port to control PTC-285NDI. Use an Ethernet cable to connect the external RS-422 controller to PTC-285NDI. You can make your own cable using the pinout information provided in this chapter.

Remote Control Port



The RS-422 pinouts are described below.

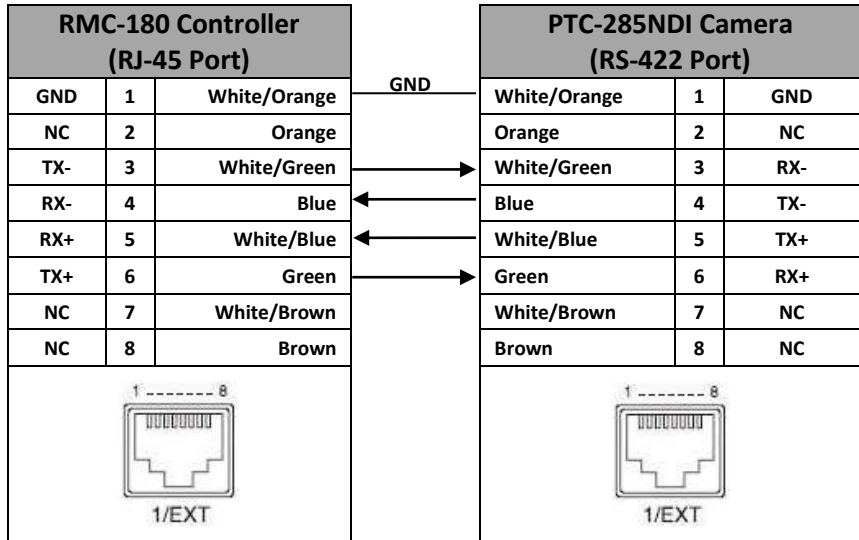

The RS-232 pinouts are described below.

RS-232



20. Firmware Update

Datavideo usually releases new firmware containing new features or reported bug fixes from time to time. Customers can either download the firmware as they wish or contact their local dealer or reseller for assistance.

This section outlines the firmware upgrade process which should take *approximately few minutes to complete*.

The existing settings should persist through the *firmware upgrade process, which should not be interrupted once started* as this could result in a non-responsive unit.

20.1 Firmware Update by the PTC-285NDI Firmware Update Tool

Requirements

- PTC-285NDI Unit
- PC/Laptop
- Latest Firmware
- Download from: <https://www.datavideo.com/product/PTC-285NDI>
- Ethernet Cable

Procedure

1. At first, please confirm that the IP address of your laptop is set within the same LAN as the PTC-285NDI camera. Please use an Ethernet cable to connect from the RJ-45 Ethernet port of your laptop to the DVIP port which is on the rear panel of the PTC-285NDI.
2. Please download the PTC-285NDI firmware “VXxxD_Ax.D_Vx.x.xxx_xx.xM_yyyyymmdd” and firmware update tool “upgrade vx.x” from Datavideo official website.
3. Please unzip the downloaded firmware and firmware update tool to the hard disk of your laptop.
4. Please double-click the firmwar3e update tool upgrade.exe  upgrade .

5. Please select the LAN IP address which is set by your laptop from the “Interface” drop-down menu. After that, please press the “Search” button.

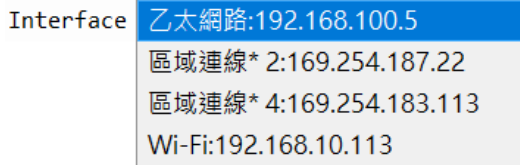

6. Users can see that the interface of the firmware update tool is shown as following diagram, please click the searched IP Address.

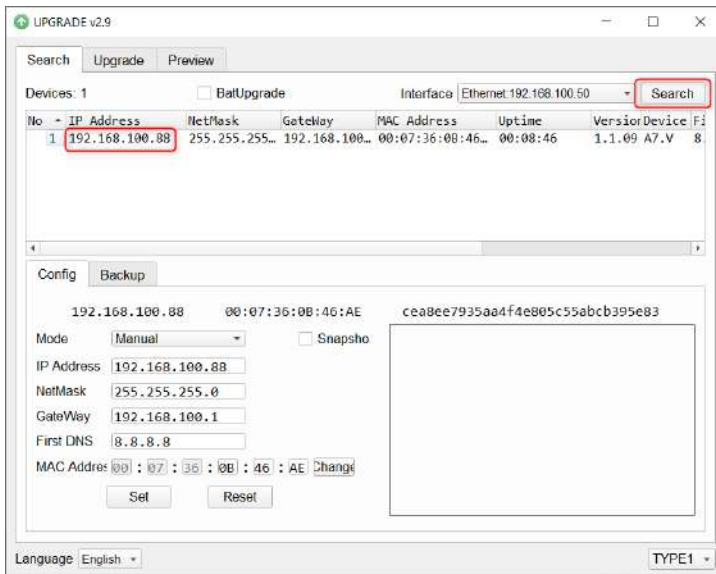

7. Please select the “Upgrade” option and then users can see the interface which is shown as following diagram.

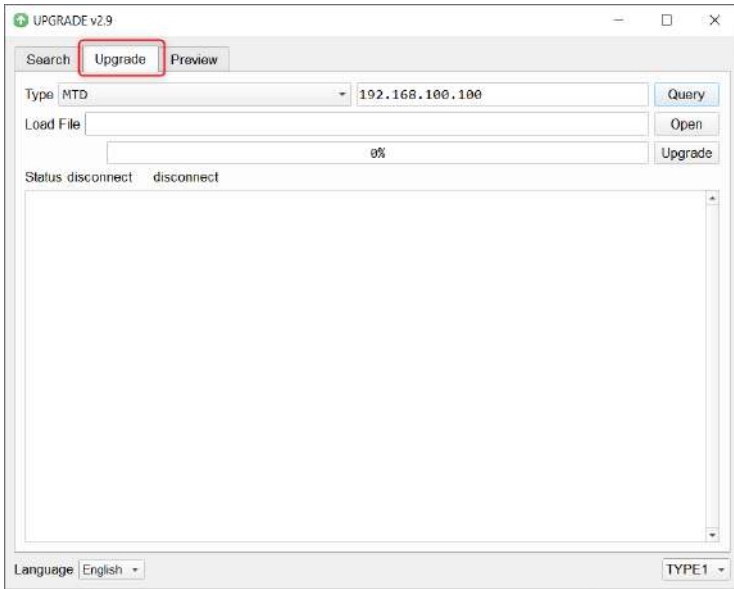

8. Please click the “Open” button and select the downloaded latest firmware.

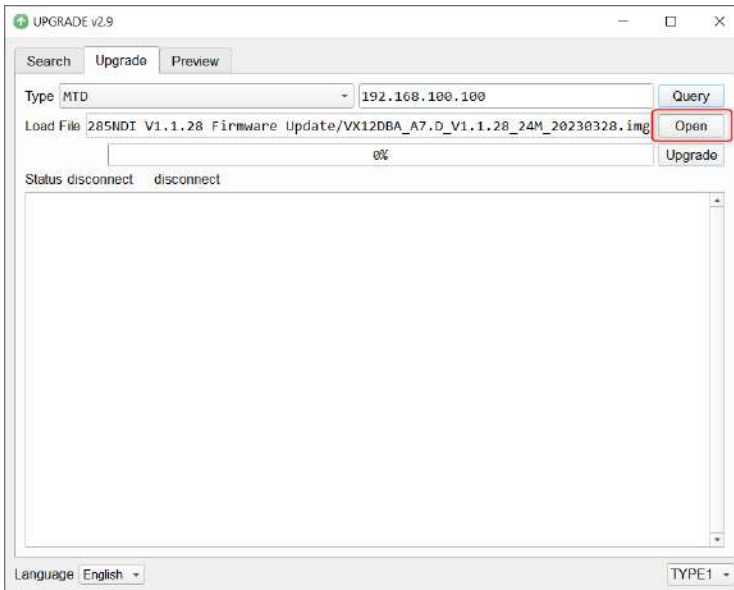

9. Please click the “Upgrade” button for starting the firmware upgrading. At this time, the external connected monitor will show the wording “**Upgrading! Please Wait!**”

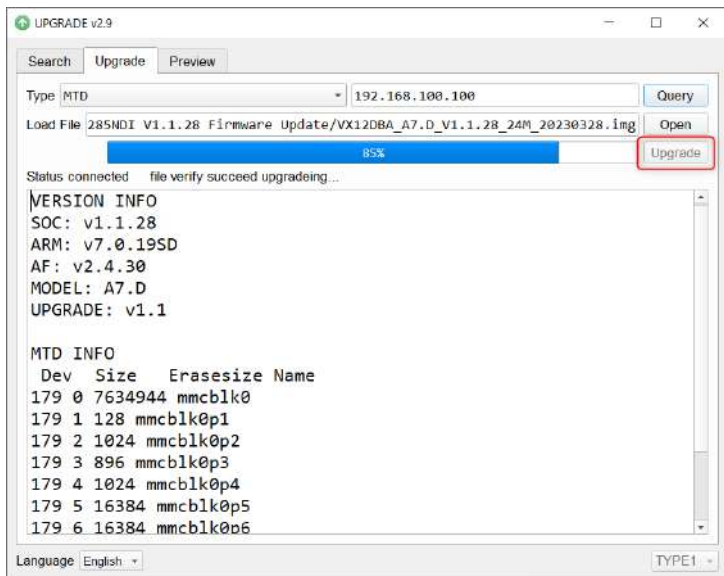

10. After the firmware upgrading is finished, the PTC-285NDI camera will reboot automatically, please click the “OK” button and then the firmware upgrade procedure is completed.

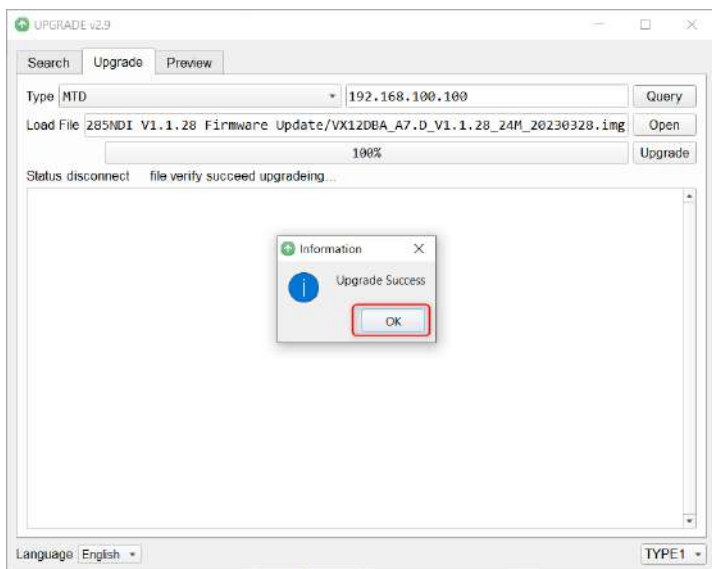

20.2 Firmware Update by the USB Flash Drive Requirements

- PTC-285NDI Unit
- USB 2.0 or USB3.x USB Flash Drive x 1
- Laptop
- Latest firmware files

Download from: <https://www.datavideo.com/product/PTC-285NDI>

- Ethernet Cable

Procedure

1. At first, please format your USB flash drive in FAT32 format.
2. Please download the latest PTC-285NDI firmware file from Datavideo official website's PTC-285NDI product page <https://www.datavideo.com/product/PTC-285NDI> and then save it to the hard disk of your laptop.
3. Please unzip the downloaded firmware file and then save the latest firmware file "VX12D_A5.D_Vx.x.xxx_31.5M_yyyymmdd.img" into the root directory of your USB flash drive.

 VX12D_A5.D_V9.0.897_31.5M_20210312.img

4. Please insert your USB flash drive with the latest firmware file into the "F/W UPGRADE ONLY" USB interface which is located on the rear panel of the PTC-285NDI.



5. Please press the "MENU" button  from the PTC-285NDI remote controller to open the OSD menu.

6. Please move down the PTC-285NDI remote controller's "Microjoystick"



to the "Setup" option in the OSD menu.

7. After the “Setup” option is selected, please press the “Microjoystick”



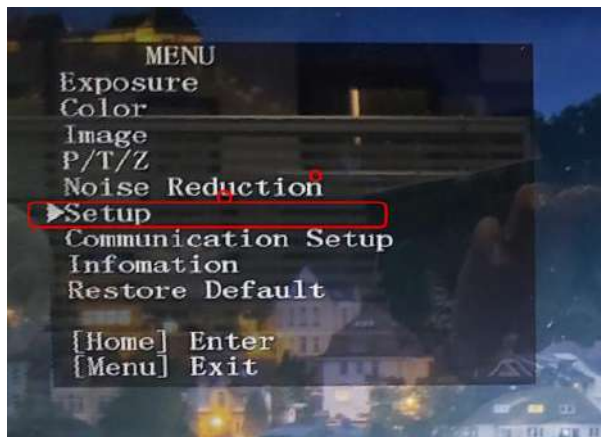

from the PTC-285NDI remote controller to enter the “Setup” page.

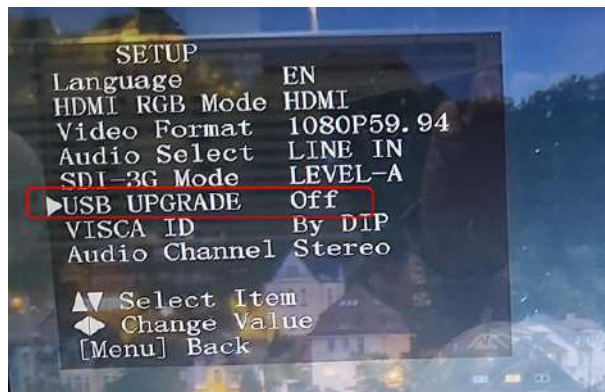

8. Please move down the “Microjoystick” of the PTC-285NDI remote controller to the “USB Upgrade” option in the “Setup” page.



9. Please move the “Microjoystick”  of the PTC-285NDI remote controller to the left side or right side to set the “USB Upgrade” option as

“On”. After that, please press the “Microjoystick”  from the PTC-285NDI remote controller for confirmation. And then the PTC-285NDI will start the firmware update procedure automatically. During the process of the firmware update procedure, the reminder “**Updating! Please Wait!**” will be shown on the screen. When the firmware update procedure is done, the PTC-285NDI will reboot automatically and the firmware update is done successfully.

Note: Please do not turn off your computer during the firmware update process to prevent it from crashing. Moreover, there is a period of time that there is no image that will be shown on the monitor. At this moment, please do not turn off the power of the PTC-285NDI camera. The camera will reboot automatically after the whole firmware update procedure is done.

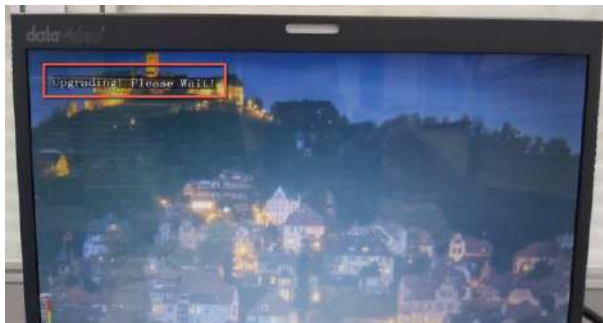
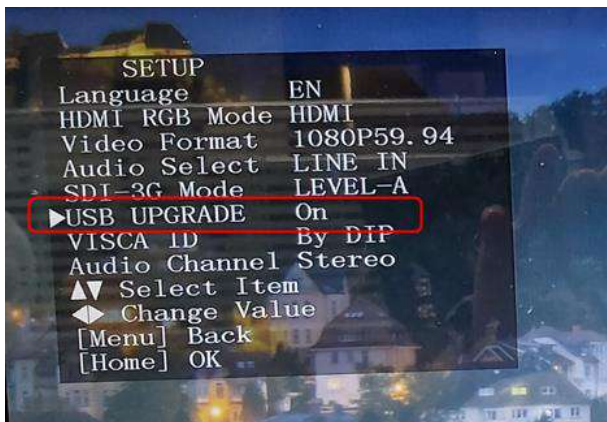

21. Frequently-Asked Questions

This section describes problems that you may encounter while using PTC-285NDI. If you have any questions, please refer to related sections and follow all suggested solutions. If problem still exists, please contact your distributor or the service center.

No.	Problems	Solutions
1.	What are important points for product maintenance?	<ol style="list-style-type: none">1. If the camera will not be used for a long time, please unplug the 12V DC power plug, and remove AC power adapter from AC outlet.2. Use soft cloth or tissue to clean the camera.3. After washing the camera lens, dry it with a soft dry cloth. Use a neutral detergent rather than acidic or corrosive detergents to clean the lens.
2.	There is no output video.	<ol style="list-style-type: none">1. Check that your power is properly connected. This is indicated by the power LED.2. After you reboot the camera, please check that whether the camera can do the self-test normally or not.3. Please check that the camera is connected correctly to the external connected monitor.
3.	I have seen image jitter while zooming in or out.	<ol style="list-style-type: none">1. Make sure the camera is properly mounted.2. Make sure that machines that could cause vibration are not in proximity of the camera.
4.	There is no image by using the IE browser.	Please go the the VLC website (http://www.videolan.org/vlc) to download the 32-bit VLC media player. After it is installed, the screen will be shown normally when connecting to the camera.

5.	The camera can not be accessed by using the IE browser.	<ol style="list-style-type: none"> 1. Use PC to access the internet to see whether it can operate normally or not. At first, please solve the network failure that is caused by the computer virus until the PC and the camera can ping each other. 2. Please remove the Ethernet cable and then connect the PC to the camera directly. After that, please reset the IP address of the PC.
6.	The remote control is not working.	<ol style="list-style-type: none"> 1. Try setting the camera to CAM1 and try again. 2. Make sure the remote control's battery is fully charged. 3. Check your device working mode. 4. Make sure the OSD menu is closed. <p>The remote control cannot be used if the OSD menu is opened.</p>
7.	The serial port is not working properly.	<ol style="list-style-type: none"> 1. Make sure your baud rate and device addresses are correct. 2. Check your device working mode. 3. Make sure the OSD menu is closed. <p>The remote control cannot be used if the OSD menu is opened.</p>
8.	Can not login to the Web control interface.	<ol style="list-style-type: none"> 1. Please check your Ethernet cable. 2. Please check your Ethernet setting such as the IP address.

22. Dimensions

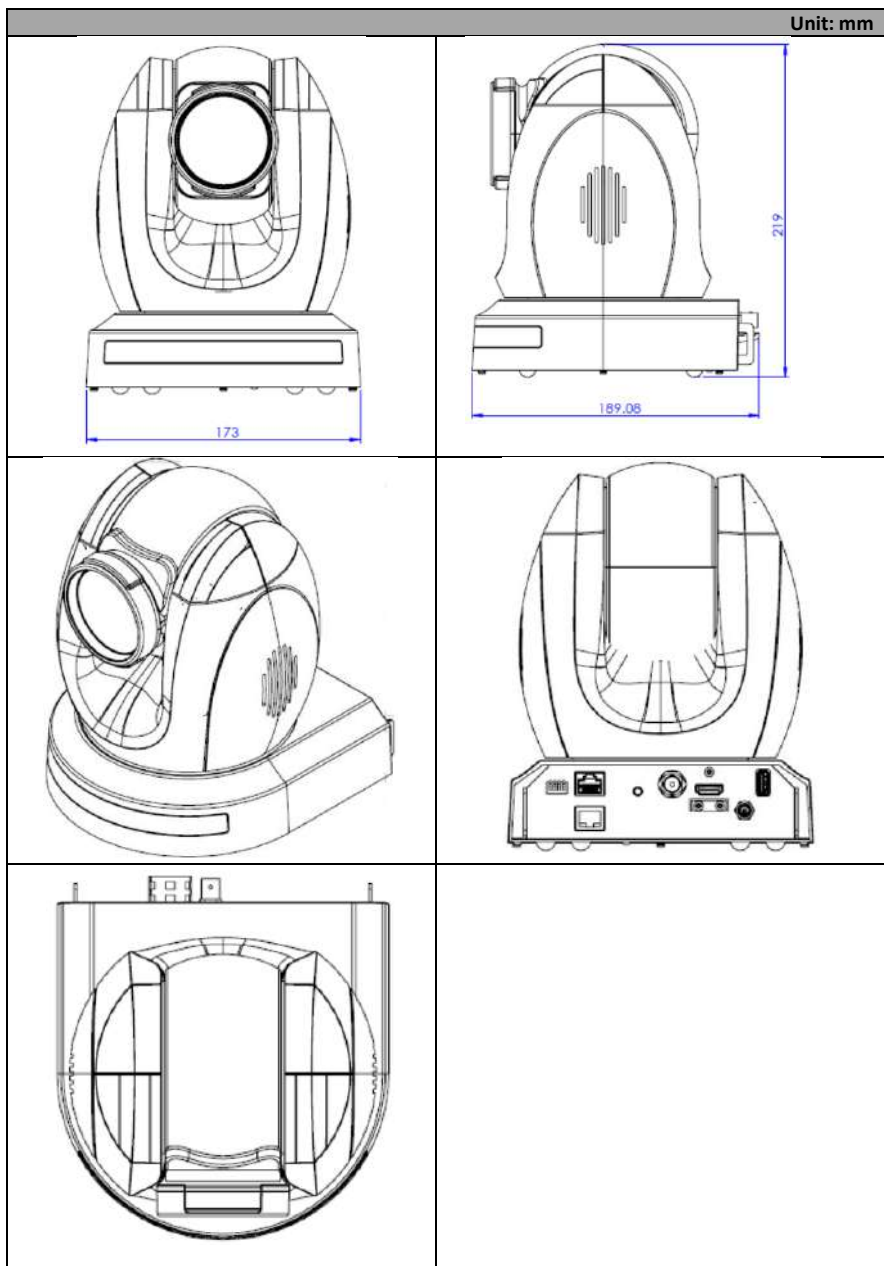

23. Specifications

Camera Parameters	
Product Name	4K NDI Tracking PTZ Camera
Video Format	2160p60/59.94/50/30/29.97/25 1080p60/59.94/50/30/29.97/25 1080i60/59.94/50 720p60/59.94/50 *2160p60/59.94/50 YUV 4:2:2
Image Sensor	1/2.8" CMOS
Effective Pixels (approx.)	8.51Mega Pixels
S/N Ratio	≥55dB
Min. Illumination	0.5 Lux @ (F1.8, AGC ON)
Electronic Shutter	1/30s ~ 1/10000s
Zoom Ratio	12x Optical Zoom, 16x Digital Zoom
Gamma	Off / Normal
Iris Control	Auto / Manual
Digital Noise Reductions	3D
On-Screen Display (OSD)	English/Simplified Chinese/Traditional Chinese
White Balance	Auto, Indoor, Outdoor, OnePush, Manual, VAR
AGC / Gain Control	Yes
Mirror / Flip Image	Yes
Focus Mode	Auto / Manual
Panning / Tilting Range	Pan: 300 degrees, Tilt: +130 to -15 degrees
Panning / Tilting Speed	Pan: 0.876°/s~43°/s Tilt: 0.693°/s ~21.32°/s
Preset	255 Position
Focal Length	12x, f=4.4 (wide) to 52.8 (tele) mm F1.8 to F2.6

Field of View (Horizontal, Wide)	80°
Image Compensation	Back light compensation
Input /Output Interfaces	
Video Output	HDMI 2.0 x1 3G-SDI x1 10/100/1000M RJ-45 (PoE) x1
Audio Input	3.5 mm x1 (mic in/line in) switch from Web UI
Tally LED	Yes
Lens Filter	N/A
Control Protocol	Pelco-D, Pelco-P, VISCA, VISCA over IP, DVIP, NDI
Remote Control Interface	IR Web GUI RS-422 DVIP NDI
Video Compression Format	H.264/H.265/MJPEG
Audio Compression Format	AAC
Audio Bitrate	96Kbps, 128Kbps
Streaming Protocols	RTSP, RTMP(S), Onvif, Multicast, SRT, NDI Hx3 (1080p)
First Stream Supported Resolution	3840x2160 1920x1080 1280x720 1024x576 960x540 640x480 640x360
Second Stream Supported Resolution	720x480 640x360 480x270 320x240
Video Bitrate	32Kbps ~ 50Mbps (Single Stream)

Video Bitrate Mode	VBR, CBR
Encoding Frame rate	50Hz: 1-50fps 60Hz: 1-60fps
POE	IEEE 802.3at
F/W Update	Via Web UI (DVIP) or USB 2.0
IR Control	Yes
Camera Control Unit	RMC-180 series/RMC-300 series/PTZ View Assist APP
Tripod Mount	1/4-20 UNC
Optional Accessories	WM-1/ WM-10/ WM-11
Color	Dark Blue/White
Dimension (LxWxH)	173 (W) x 219 (H) x 189.08 (D) mm
Weight	2.6kg
Operating Temp. Range	0~40 °C
Power	DC 12V 21W

Note

Note

Note

Service & Support

It is our goal to make your products ownership a satisfying experience. Our supporting staff is available to assist you in setting up and operating your system. Please refer to our web site www.datavideo.com for answers to common questions, support requests or contact your local office below.

www.datavideo.com/product/PTC-285NDI

datavideo
www.datavideo.com



@DatavideoUSA @DatavideoIndia2016
@DatavideoEMEA @Datavideojapan
@DatavideoTaiwan @DatavideoLatam
@DatavideoAsia @DatavideoBrasil



@Datavideo
@Datavideo_EMEA
@Datavideo_Taiwan



@DatavideoUSA
@DVTWDVCN



@DatavideoUSA
@DatavideoEurope

All the trademarks are the properties of their respective owners.