

datavideo

POE NDI®|HX

4K
50/60 UHD



BC-15C/ BC-15CN

BC-15P/ BC-15PN

4K POV Camera Series

www.datavideo.com

POE NDI®|HX

4K
50/60 UHD

4K POV Camera Series



BC-15C/ BC-15CN
(Lens is NOT included)

BC-15P/ BC-15PN



The BC-15 is a light and compact 4K POV camera designed to use a custom C/CS mount lens for your application. You can output the video via HDMI or ultra low latency SRT, thus enhancing versatility of camera configuration. With DVIP control protocol, you can integrate the camera into any Datavideo video production system. In addition to being a standard HDMI camera, the BC-15 also offers an NDI-HX upgrade version which can be used in any NDI systems. While enjoying the convenience of remote control, you can also take advantage of the smoothness of NDI video transmission.

Features

- Support 4K 50/60p video output
- 1/2.3 CMOS sensor for low light shooting.
- Standard replaceable CS mount lens (BC-15C series)
- Support high efficiency streaming for Live Streaming or preview.
- Low latency SRT streaming engine allowing online switching to dvCloud with nearly zero latency.
- NDI-HX output allows integration of the camera to any NDI environments (BC-15PN/CN).
- Supports DC-IRIS (BC-15C series).
- Control via physical buttons or APP.

BC-15P/ BC-15PN

Front



Top



Rear



Bottom



Side
BC-15P



BC-15PN



BC-15C/ BC-15CN

Front



Top



Rear



Bottom



Side
BC-15C



BC-15CN



Application Environments

Elegant and Compact Design

Because of its cube shape and compactness, the BC-15 camera can be installed at any place in any orientation.



• Gaming Tournaments



• Lecture Recording



• Live Presentation



• Influencer



Compact Brilliance, 4K Excellence Unleashed!



Experience the power of 4K with the BC-15 series! Its small box design offers unparalleled flexibility for mounting anywhere you need. BC-15 series boasts a 1/2.3" 4K CMOS sensor that captures stunningly detailed images, ensuring exceptional quality for your visuals.

POE(Power over Ethernet)



With Power over Ethernet, power can be transmitted over a single CAT cable.

Elevate Your Content with Seamless 4K Streaming



During video production, you can stream your program to different platforms such as YouTube and Facebook. If using Datavideo dvCloud, you can even stream your program to 25 different platforms at the same time while backing up your program on the cloud server.

SRT



Low latency SRT streaming engine allowing online switching to dvCloud with nearly zero latency

Many viewers must have experienced streaming issues such as video stuttering or frame loss which could be caused by fluctuating bandwidth and network instability. dvCloud adopts SRT protocol which mitigates frame loss as your network becomes unstable. If you are still having issues with RTMP streaming, dvCloud is your best solution to unpleasant viewing experience.

NDI|HX (BC-15CN/BC-15PN)



NDI-HX output allows seamless integration of the camera to NDI systems.

No messy cabling. Simply transmit video, audio, power, tally signals and control commands over a single Ethernet cable.

Custom Lens Design

Customize the lens according to different application environments in order to achieve flawless video capture.

BC-15P/ BC-15PN (With two lenses)



YT10112 (Standard lens)



YT10110 (Wide-angle lens)

Model No.	Focal Length FL (mm)	Aperture	Mount	Field of View(D)
YT10112	6mm	f/1.0	M16	44.1°
YT10110	2.8mm	f/1.0	M16	82.7°



BC-15C/ BC-15CN (No lens)



33-303



YT3011CS-4K



HV03610D-IR-S(4K)



EG3Z0409FCS-MPWIR



EG6Z0915FCS-MPWIR



EG3Z3915FCS-MPWIR



Item	Brand	Model No.	Focal Length FL (mm)	Zoom Ratio	Aperture(F/#)	Mount	Supported sensor size	Resolution
1	Edmund Optics	33-303	12	Fixed	f/1.8 - f/11	C - Mount	1/1.8"	4K
2	YTOT	YT3011CS-4K	3.6 - 11	3x	f/1.5 - close	CS - Mount	1/1.8"	4K
3	RICOM	HV03610D-IR-S(4K)	3.6 - 10	2.7x	f/1.8	CS - Mount	1/1.8"	4K
4	Computar	EG3Z0409FCS-MPWIR	4 - 10	2.5x	f/0.9	CS - Mount	1/1.8"	4K
5	Computar	EG6Z0915FCS-MPWIR	9 - 50	5.5x	f/1.5 - f/360	CS - Mount	1/1.8"	4K
6	Computar	EG3Z3915FCS-MPWIR	3.9 - 10	2.5x	f/1.5 - f/360	CS - Mount	1/1.8"	4K

CMOS sensor for low light photography

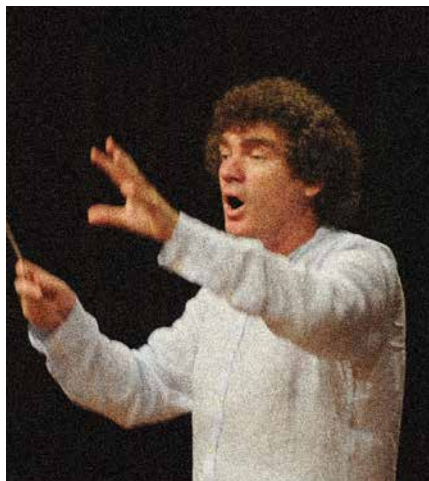

Even though the BC-15 camera is a compact camera but they are not shrunk at the expense of video quality. The built-in 1/2.3 inch 4K CMOS sensor provides the camera with the capability of capturing high quality images with stunning details.



DC-IRIS Function (BC-15C Series)

No DC-IRIS



DC-IRIS



Built-in DC-IRIS function on BC-15C Series
Most off-the-shelf C/CS lenses are manual aperture lenses but some adopt DC-IRIS technique which is thus also included in the BC-15C, making lens selection hassle-free.

Lens Distortion Calibration (BC-15C Series)

Barrel distortion



It is not uncommon to see image distortion when using different lenses on the same camera. You will either experience barrel or pincushion distortion. The BC-15C offers distortion calibration for different lenses so that you will be able to reproduce correct images using lenses of different specifications.

Distortion calibration

pincushion distortion



Distortion calibration

BC View Assist APP

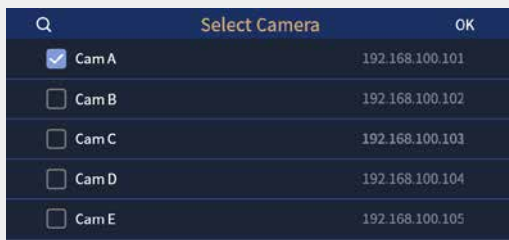

Camera

The APP will automatically scan the network for connected DVIP devices. All detected BC-15 devices will be listed for selection.

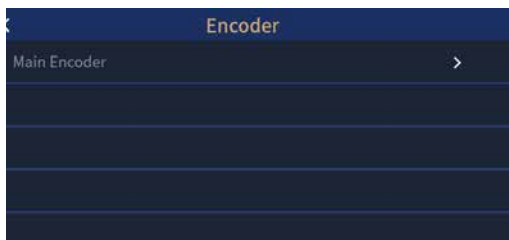

Encoder

Provides video coding standard or high efficiency video coding for various major streaming platforms.

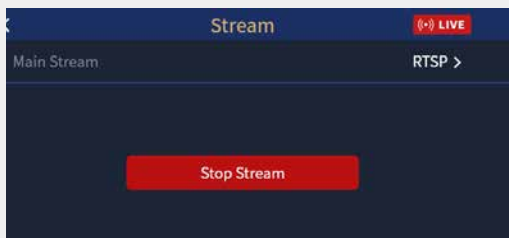

Streaming

The encoder uses the latest SRT protocol as well as the standard RTMP/RTMPS protocols. The multiview screen is streamed to the APP.

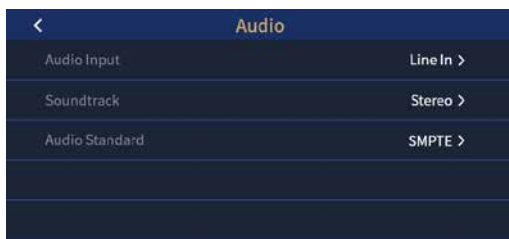

Audio

Professional audio settings allow you to physically configure the audio input. You can make selection of the audio input type (Line/ MIC), audio type (mono/stereo) and audio standard (SMPTE/EBU).

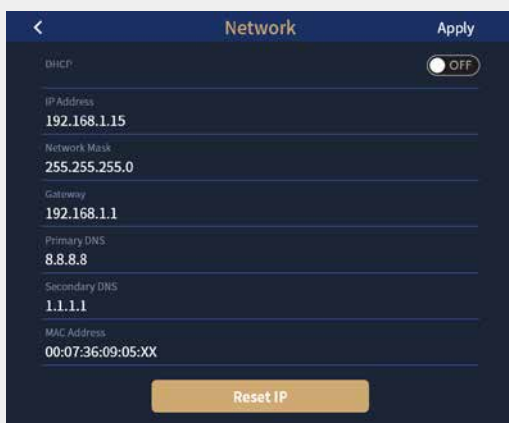

Network

You can access the BC-15 directly from the mobile APP so a PC is not needed for configuring remote settings. Default DHCP setting makes the device plug and play. Static IP will be activated if the router does not support DHCP. Enter the IP address manually.

Professional Camera Settings

Physical Buttons

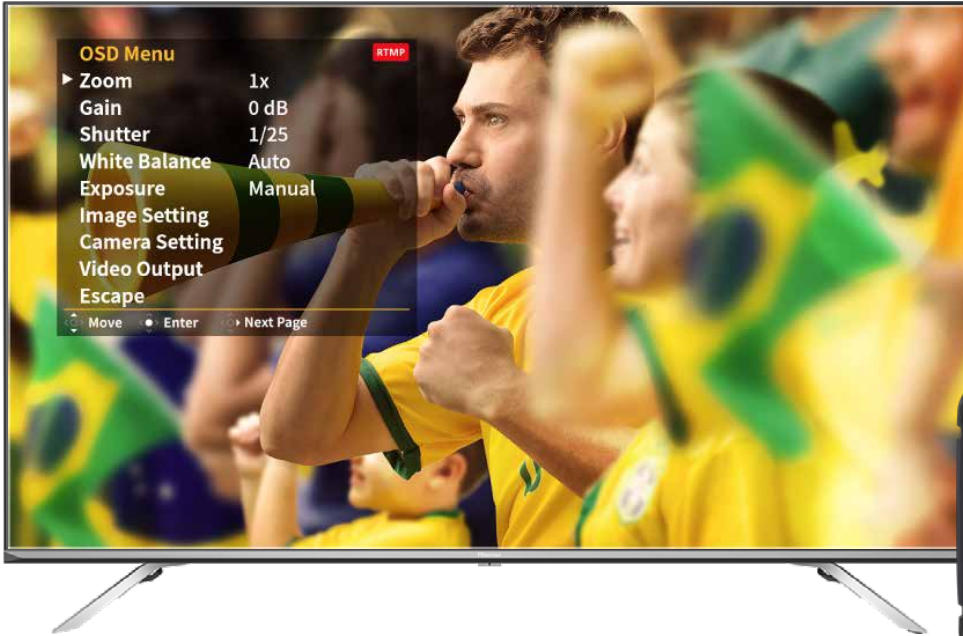

After the camera is installed and configured, use physical buttons found on the rear panel of the BC-15 series to make changes to the settings, making remote control an optional item.



Configuring live video on the mobile phone

You can adjust the video settings on the mobile phone and use the sub encoder to preview the video as you make changes to the settings. You can also monitor major camera settings such as HDMI output resolution, camera name, and stream status.

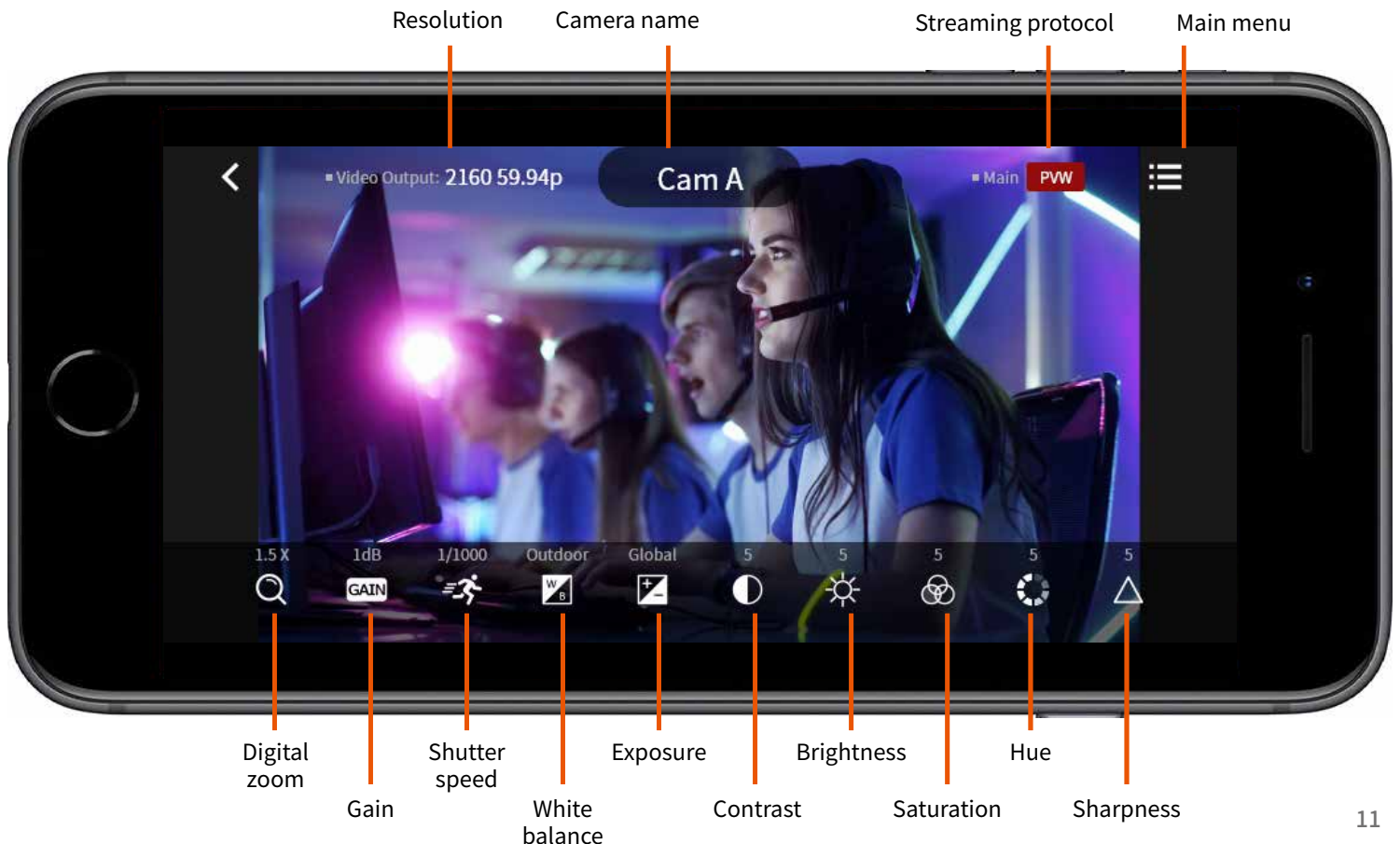

System Diagram

System setup for seminars and lectures

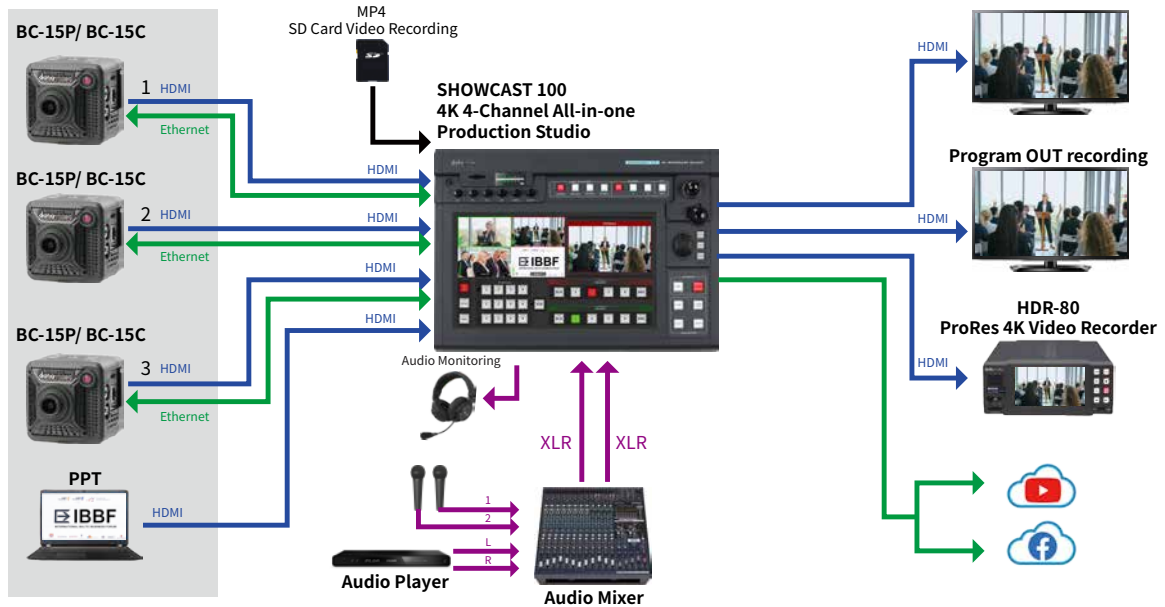

System setup for live streaming

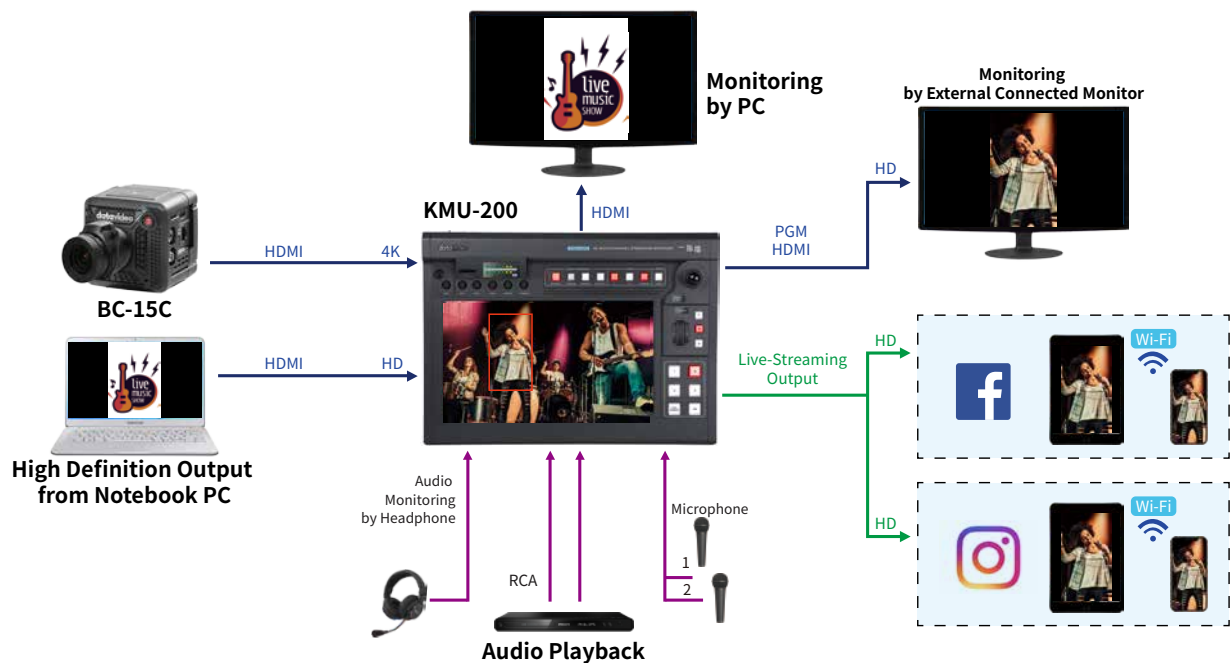

System Diagram

System setup for gaming tournaments

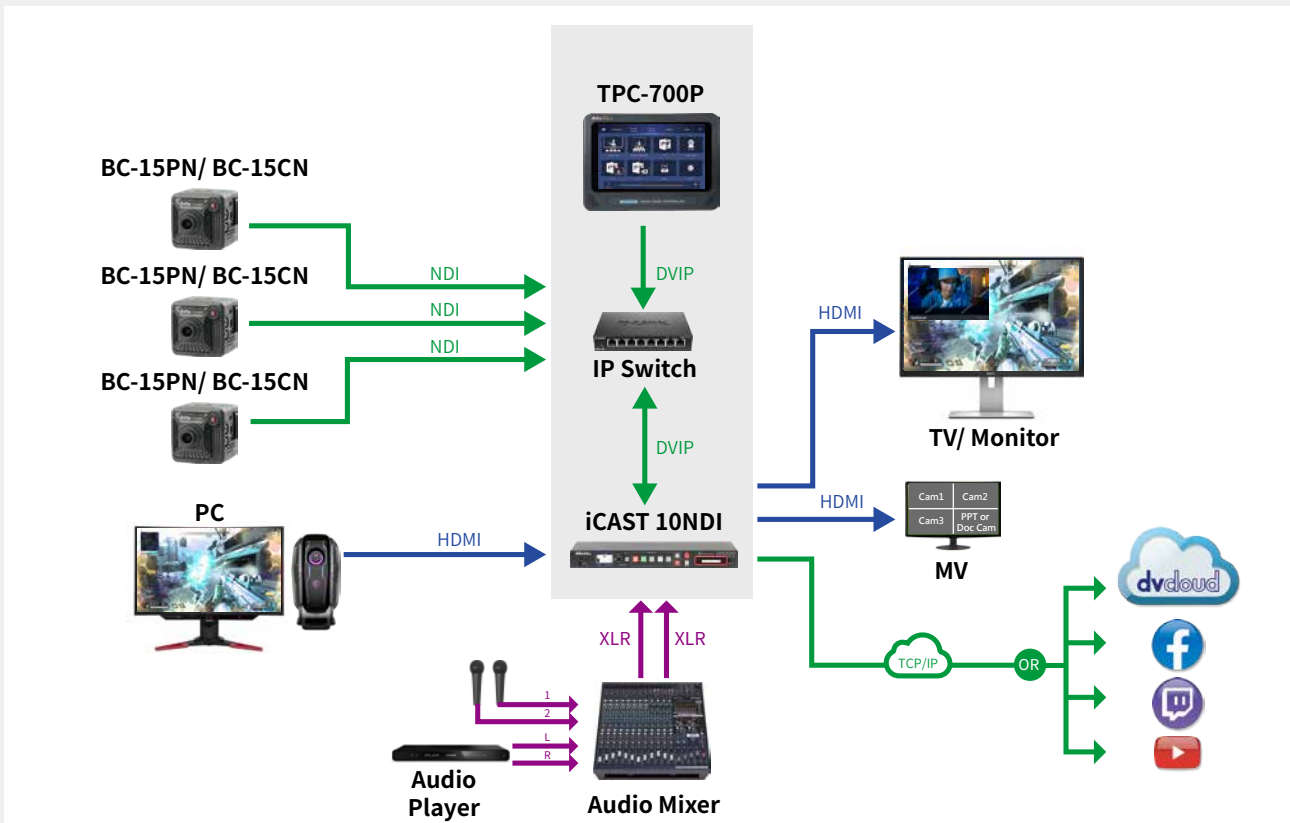

Dimensions

BC-15C

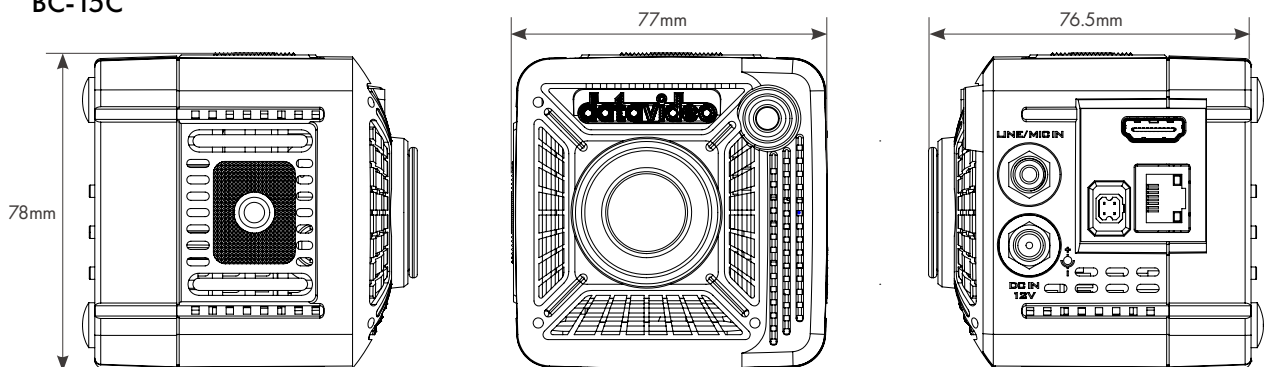

BC-15P

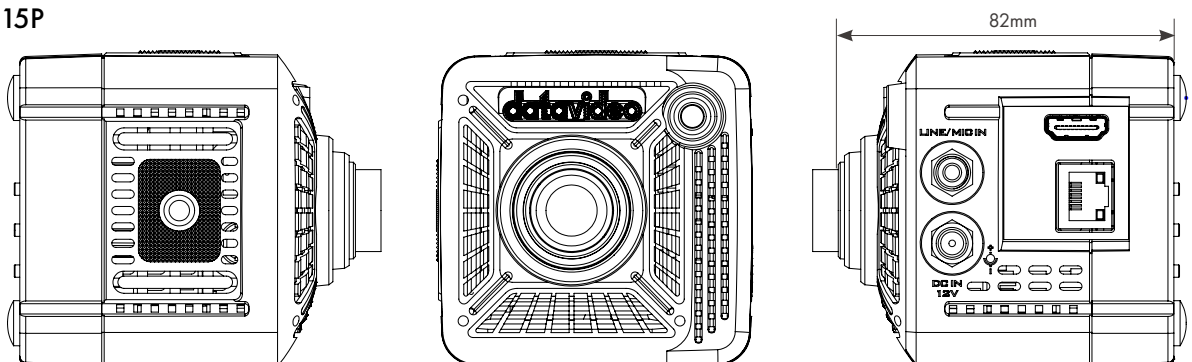



NDI®|HX



NDI®|HX

Product Name	BC-15P 4K POV Camera	BC-15PN 4K NDI POV Camera	BC-15C 4K CS MOUNT POV Camera	BC-15CN 4K NDI CS MOUNT POV Camera
Video format/Resolution	2160p 60/59.94/50/30/29.97/25 1080p 60/59.94/50/30/29.97/25	2160p 60/59.94/50/30/29.97/25 1080p 60/59.94/50/30/29.97/25	2160p 60/59.94/50/30/29.97/25 1080p 60/59.94/50/30/29.97/25	2160p 60/59.94/50/30/29.97/25 1080p 60/59.94/50/30/29.97/25
Image Sensor	1/2.3" CMOS	1/2.3" CMOS	1/2.3" CMOS	1/2.3" CMOS
Effective Pixels (approx.)	12.3Mega Pixels	12.3Mega Pixels	12.3Mega Pixels	12.3Mega Pixels
S/N Ratio	50 dB	50 dB	50 dB	50 dB
Min. Illumination	0.5Lux (F1.0, AGC ON)	0.5Lux (F1.0, AGC ON)	0.5Lux (F1.0, AGC ON) * depend on Lens	0.5Lux (F1.0, AGC ON) * depend on Lens
Electronic Shutter	1/25(1/30), 1/50(1/60), 1/75(1/90), 1/100(1/120), 1/125(1/150), 1/150(1/180), 1/200(1/210), 1/500(1/600), 1/1000(1/1200), 1/2000(1/2400), 1/4000(1/4800), 1/8000(1/9000) sec	1/25(1/30), 1/50(1/60), 1/75(1/90), 1/100(1/120), 1/125(1/150), 1/150(1/180), 1/200(1/210), 1/500(1/600), 1/1000(1/1200), 1/2000(1/2400), 1/4000(1/4800), 1/8000(1/9000) sec	1/25(1/30), 1/50(1/60), 1/75(1/90), 1/100(1/120), 1/125(1/150), 1/150(1/180), 1/200(1/210), 1/500(1/600), 1/1000(1/1200), 1/2000(1/2400), 1/4000(1/4800), 1/8000(1/9000) sec	1/25(1/30), 1/50(1/60), 1/75(1/90), 1/100(1/120), 1/125(1/150), 1/150(1/180), 1/200(1/210), 1/500(1/600), 1/1000(1/1200), 1/2000(1/2400), 1/4000(1/4800), 1/8000(1/9000) sec
Zoom Ratio	2x Digital Zoom	2x Digital Zoom	2x Digital Zoom Optical zoom depend on Lens	2x Digital Zoom Optical zoom depend on Lens
Gamma Control	Standard / Mode1 / Mode2 / Mode3	Standard / Mode1 / Mode2 / Mode3	Standard / Mode1 / Mode2 / Mode3	Standard / Mode1 / Mode2 / Mode3
Iris Control	Fixed IRIS (F1.0)	Fixed IRIS (F1.0)	DC IRIS supported * depend on Lens	DC IRIS supported * depend on Lens
Digital Noise Reductions	2D/3D	2D/3D	2D/3D	2D/3D
On-Screen Display (OSD)	English/Simplified Chinese/Traditional Chinese	English/Simplified Chinese/Traditional Chinese	English/Simplified Chinese/Traditional Chinese	English/Simplified Chinese/Traditional Chinese
White Balance	Auto, Indoor, Outdoor, OnePush, Color Temp., R/B Gain, Lock	Auto, Indoor, Outdoor, OnePush, Color Temp., R/B Gain, Lock	Auto, Indoor, Outdoor, OnePush, Color Temp., R/B Gain, Lock	Auto, Indoor, Outdoor, OnePush, Color Temp., R/B Gain, Lock
AGC / Gain Control	Auto(AGC) / Manual / Lock (Follow Exposure Mode)	Auto(AGC) / Manual / Lock (Follow Exposure Mode)	Auto(AGC) / Manual / Lock (Follow Exposure Mode)	Auto(AGC) / Manual / Lock (Follow Exposure Mode)
HDR/WDR	WDR	WDR	WDR	WDR
Mirror / Flip Image	Yes	Yes	Yes	Yes
Focus Mode	Full Manual	Full Manual	Full Manual	Full Manual
Panning / Tilting Range	----	----	----	----
Panning / Tilting Speed Preset	----	----	----	----
Focal Length	Standard Lens: 6mm Wide Lens: 2.8mm	Standard Lens: 6mm Wide Lens: 2.8mm	Depend on Lens	Depend on Lens
Field of View (Horizontal, Wide)	Standard Lens: H: 38.6, V:21.9, D: 44.1 Wide Lens: H: 75.5, V:46.6, D:82.7	Standard Lens: H: 38.6, V:21.9, D: 44.1 Wide Lens: H: 75.5, V:46.6, D:82.7	Depend on Lens	Depend on Lens
Image Compensation	Auto	Auto	Auto	Auto
Video Output	HDMI 2.0 x1	HDMI 2.0 x1	HDMI 2.0 x1	HDMI 2.0 x1
Audio Input	3.5mm Line in/Mic in (Stereo)	3.5mm Line in/Mic in (Stereo)	3.5mm Line in/Mic in (Stereo)	3.5mm Line in/Mic in (Stereo)
Tally LED	Dual color (Red, Green)	Dual color (Red, Green)	Dual color (Red, Green)	Dual color (Red, Green)
Lens Filter	IR cut built-in	IR cut built-in	IR cut built-in	IR cut built-in
Control Protocol	DVIP	DVIP	DVIP	DVIP
Remote Control Interface	RJ-45: for IP control (DVIP)	RJ-45: for IP control (DVIP)	RJ-45: for IP control (DVIP)	RJ-45: for IP control (DVIP)
Video Compression Format	H.265, H.264	H.265, H.264	H.265, H.264	H.265, H.264
Audio Compression Format	AAC	AAC	AAC	AAC
Audio Bitrate	128Kbps	128Kbps	128Kbps	128Kbps
HD IP Interface	10/100/1000M	10/100/1000M	10/100/1000M	10/100/1000M
Streaming Protocols	RTMP(S), SRT	RTMP(S), SRT, NDI	RTMP(S), SRT	RTMP(S), SRT, NDI
First Stream Supported Resolution	1920x1080 1280x720 1024x576 960x540 640x480 640x360	1920x1080 1280x720 1024x576 960x540 640x480 640x360	1920x1080 1280x720 1024x576 960x540 640x480 640x360	1920x1080 1280x720 1024x576 960x540 640x480 640x360
Second Stream Supported Resolution	----	----	----	----
Video Bitrate	1Mbps ~ 7Mbps	1Mbps ~ 7Mbps	1Mbps ~ 7Mbps	1Mbps ~ 7Mbps
Video Bitrate Mode	VBR, CBR	VBR, CBR	VBR, CBR	VBR, CBR
Encoding Frame rate	50Hz: 1-50fps 60Hz: 1-60fps	50Hz: 1-50fps 60Hz: 1-60fps	50Hz: 1-50fps 60Hz: 1-60fps	50Hz: 1-50fps 60Hz: 1-60fps
POE	IEEE 802.3af	IEEE 802.3af	IEEE 802.3af	IEEE 802.3af
F/W Update	Ethernet	Ethernet	Ethernet	Ethernet
IR Control	----	----	----	----
Camera Control Unit	RMC-300 series/BC View Assist APP	RMC-300 series/BC View Assist APP	RMC-300 series/BC View Assist APP	RMC-300 series/BC View Assist APP
Tripod Mount	1/4-20 UNC	1/4-20 UNC	1/4-20 UNC	1/4-20 UNC
Optional Accessories	----	----	----	----
Color	Black	Black	Black	Black
Dimension (LxWxH)	77mm (W) x 82mm (D) x 78mm (H)	77mm (W) x 82mm (D) x 78mm (H)	77mm (L) x 82mm (W) x 78mm (H)	77mm (L) x 82mm (W) x 78mm (H)
Weight	200g	200g	204g (Lens not included)	204g (Lens not included)
Operating Temp. Range	0-40 ° C	0-40 ° C	0-40 ° C	0-40 ° C
Power	DC 12V 9W	DC 12V 9W	DC 12V 9W	DC 12V 9W
What's in the Box	1 x BC-15P Main Unit 1 x Standard Lens (attached on camera with lens cap) 1 x Wide-angle Lens (attached with lens caps) 1 x DC 12V power adaptor	1 x BC-15PN Main Unit 1 x Standard Lens (attached on camera with lens cap) 1 x Wide-angle Lens (attached with lens caps) 1 x DC 12V power adaptor	1 x BC-15C Main Unit 1 x CS-C Lens adaptor ring 1 x DC 12V power adaptor	1 x BC-15CN Main Unit 1 x CS-C Lens adaptor ring 1 x DC 12V power adaptor



@DatavideoUSA @DatavideoAsia
@DatavideoEMEA @DatavideoIndia2016
@DatavideoTaiwan @Datavideojapan



@Datavideo
@Datavideo_EMEA
@Datavideo_Taiwan



@DatavideoUSA
@DVTWDVCN



@DatavideoUSA
@DatavideoEurope

Disclaimers of Product and Services

This brochure is intended as a guide only. We reserve the right to change specifications and availability without prior notice. While we strive for complete accuracy, be aware that it may contain errors and omissions. Prior to purchase, please check with your local Datavideo office or authorised distributor.

Ver.20231127