

AI Auto Tracking PTZ Camera

— User Manual —

TR335 / TR335N / TR315 / TR315N / TR211 / TR311V3 / TR325 / TR325N
PTC310V3 / PTC310UV3 / PTC310UNV3 / PTC320UV3 /
PTC320UNV3 / PTC330UV3 / PTC330UNV3

Federal Communications Commission

NOTE: This equipment has been tested and found to comply with the limits for a Class A digital device, pursuant to part 15 of the FCC Rules. These limits are designed to provide reasonable protection against harmful interference when the equipment is operated in a commercial environment. This equipment generates, uses, and can radiate radiofrequency energy and, if not installed and used in accordance with the instruction manual, may cause harmful interference to radio communications. Operation of this equipment in a residential area is likely to cause harmful interference in which case the user will be required to correct the interference at his own expense.

FCC Caution: Any changes or modifications not expressly approved by the party responsible for compliance could void the user's authority to operate this equipment.

This device complies with part 15 of the FCC Rules.

Operation is subject to the following two conditions:

- (1) This device may not cause harmful interference, and
- (2) this device must accept any interference received, including interference that may cause undesired operation.

Warning

This is a class A product. In a domestic environment, this product may cause radio interference in which case the user may be required to take adequate measures.

This Class A digital apparatus complies with Canadian ICES-003. Cet appareil numérique de la classe A est conforme à la norme NMB-003 du Canada.

Caution

Risk of Explosion if Battery is replaced by an Incorrect Type.

Dispose of Used Batteries According to the Instructions.

Remote Control Battery Safety Information

- Store batteries in a cool and dry place.
- Do not throw away used batteries in the trash. Properly dispose of used batteries through specially approved disposal methods.
- Remove the batteries if they are not in use for long periods of time. Battery leakage and corrosion can damage the remote control. Dispose of batteries safely and through approved disposal methods.
- Do not use old batteries with new batteries.
- Do not mix and use different types of batteries: alkaline, standard (carbon-zinc) or rechargeable (nickel-cadmium).
- Do not dispose of batteries in a fire.
- Do not attempt to short-circuit the battery terminals.

DISCLAIMER

No warranty or representation, either expressed or implied, is made with respect to the contents of this documentation, its quality, performance, merchantability, or fitness for a particular purpose. Information presented in this documentation has been carefully checked for reliability; however, no responsibility is assumed for inaccuracies. The information contained in this documentation is subject to change without notice.

In no event will AVer Information Inc. be liable for direct, indirect, special, incidental, or consequential damages arising out of the use or inability to use this product or documentation, even if advised of the possibility of such damages.

TRADEMARKS

"AVer" is a trademark owned by AVer Information Inc. Other trademarks used herein for description purpose only belong to each of their companies.

COPYRIGHT

©2023 AVer Information Inc. All rights reserved. | August 25, 2023

All rights of this object belong to AVer Information Inc. Reproduced or transmitted in any form or by any means without the prior written permission of AVer Information Inc. is prohibited. All information or specifications are subject to change without prior notice.

NOTICE

Specifications Are Subject to Change without Prior Notice. The Information Contained Herein Is to Be Considered for Reference Only.

WARNING

- To reduce the risk of fire or electric shock, do not expose this appliance to rain or moisture. Warranty will be void if any unauthorized modifications are done to the product.
- Do not drop the camera or subject it to physical shock.
- Use the correct power supply voltage to avoid the damaging camera.
- Do not place the camera where the cord can be stepped on as this may result in fraying or damage to the lead or the plug.
- Hold the bottom of the camera with both hands to move the camera. Do not grab the lens or lens holder to move the camera.

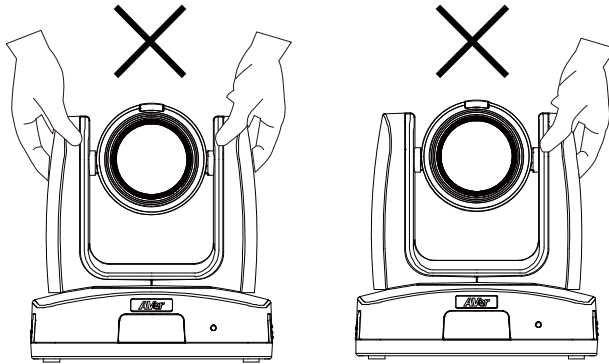

OK

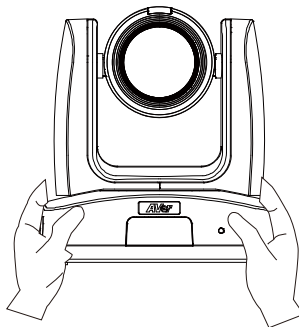

More Help

For FAQs, technical support, software and user manual download, please visit:

Headquarters

Download Center: <https://www.aver.com/download-center>
Technical Support: <https://www.aver.com/technical-support>

USA Branch office

Download Center: <https://www.averusa.com/pro-av/support/>
Technical Support: <https://averusa.force.com/support/s/contactsupport>

Europe Branch office

Download Center: <https://www.avereurope.com/download-center>
Technical Support: <https://www.avereurope.com/technical-support>

Contact Information

Headquarters

AVer Information Inc.

<https://www.aver.com>

8F, No.157, Da-An Rd., Tucheng Dist., New Taipei City 23673, Taiwan

Tel: +886 (2) 2269 8535

USA Branch office

AVer Information Inc., Americas

<https://www.averusa.com>

668 Mission Ct., Fremont, CA 94539, USA

Tel: +1 (408) 263 3828

Toll-free: +1 (877) 528 7824

Technical support: support.usa@aver.com

Europe Branch office

AVer Information Europe B.V.

<https://www.avereurope.com>

Westblaak 134, 3012 KM, Rotterdam, The Netherlands

Tel: +31 (0) 10 7600 550

Technical support: eu.rma@aver.com

Japan Branch Office

アバー・インフォメーション株式会社

<https://jp.aver.com>

〒160-0023 日本東京都新宿区西新宿 3-2-26 立花新宿ビル 7 階

Tel: +81 (0) 3 5989 0290

テクニカル・サポート: <https://jp.aver.com/technical-support>

Vietnam Branch Office

Công ty TNHH AVer Information (Việt Nam)

Tầng 5, 596 Nguyễn Đình Chiểu, P.3, Quận 3,

Thành phố Hồ Chí Minh 700000, Việt Nam

Tel: +84 (0)28 22 539 211

Contents

Package Contents	3
Package Contents	3
Optional Accessories	3
Product Introduction	4
Overview	4
Dimensions	5
Pan and Tilt Angle	8
LED Indicators	9
Device Connection	9
PoE Connection	10
RS-232 and RS-422 Connection	11
Audio Input Connection	16
Video Output Connection	17
Cable Fixing Plate Installation	18
Ceiling Mount Installation	19
Camera Installation	20
Remote Control	21
Set Up the Camera	23
OSD Menu	23
IP Address Setup	23
Static IP	23
DHCP	24
OSD Menu Tree	25
Camera	25
Video Output	28
Network	28
Advanced Setting	28
System	28

Web Setup	30
Access the Web Interface of the Camera	30
Access the Camera via AVer IPCam Utility	30
Accessing the Camera via AVer PTZ Management	32
Live View	33
Camera Control	33
Preset	35
Camera Settings.....	36
Exposure	36
Image Process	37
Video & Audio	38
Network	40
Tracking Settings.....	45
Presenter Mode.....	47
Zone Mode	51
Hybrid Mode	53
Gesture.....	55
NDI	57
System.....	59
Appendix	61
VISCA RS-232 Command Table	61
Visca over IP Settings	65
CGI Command.....	66
Pelco P Command.....	69
Pelco D Command	70

Package Contents

Package Contents



Camera Unit

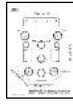

Drilling Paper

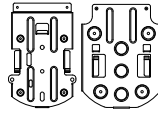

Ceiling Mount
Bracket (x2)



Quick Start Guide

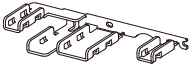

Cable Fixing Plate



M2 x 4mm
Screw (x3)

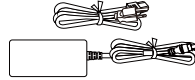

Power Adapter &
Power Cord



1/4"-20 L=6.5mm
Screw (x2)



Remote Control



M3 x 6mm
Screw (x3)



DIN8 to D-Sub9
Cable



RS-232 In/Out
Y Cable

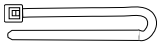

Cable Ties (x4)

*The power cord will vary depending on the standard power outlet of the country where it is sold.

Optional Accessories

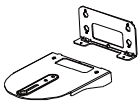

Wall Mount
Bracket



Camera Controller
(CL01)

* For details on optional accessories, please consult with your local dealer.

Product Introduction

Overview

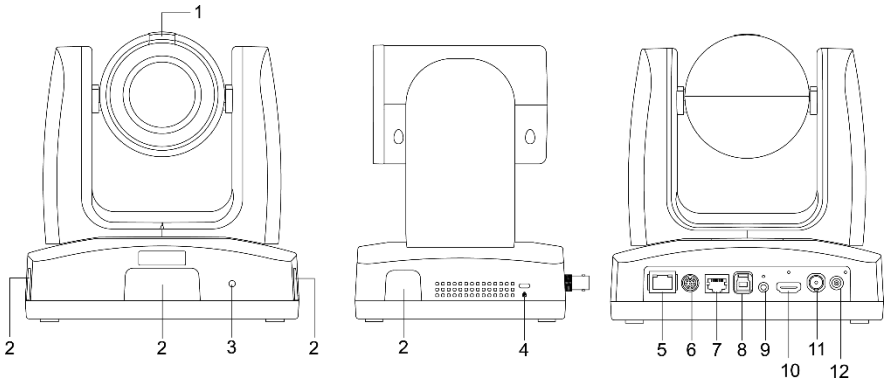

- | | | | |
|---|-------------------|----|------------------------------|
| 1 | Tally Lamp | 7 | RS-422 Port |
| 2 | IR Sensor | 8 | USB 3.0 Port (Type-B) DC 12V |
| 3 | LED Indicator | 9 | Audio In* |
| 4 | Kensington Lock | 10 | HDMI Port |
| 5 | PoE+ IEEE 802.3AT | 11 | 3G-SDI** |
| 6 | RS-232 Port | 12 | DC Power Jack |

*Line input level: 1Vrms (max.).

*Mic input level: 50mVrms (max.); Supplied voltage: 2.5V.

**The model names with "H" do not have this feature.

Dimensions

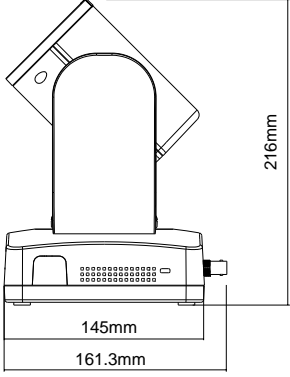
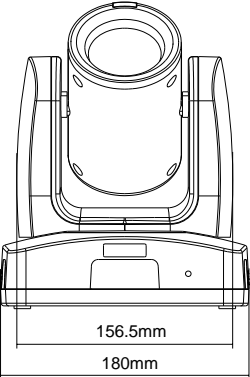
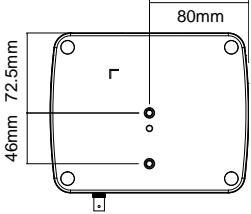
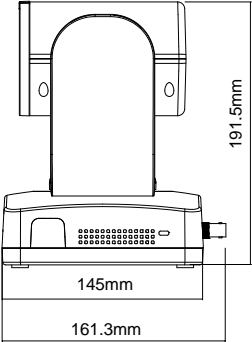
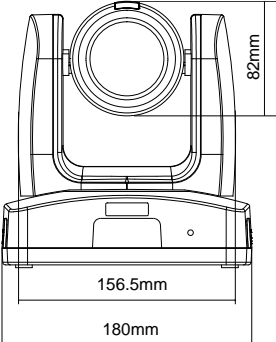

Ceiling Mount

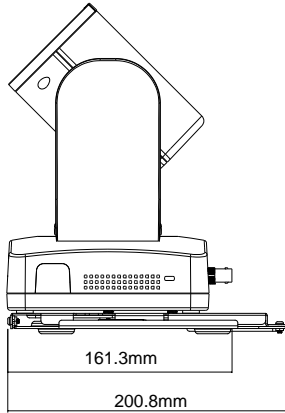
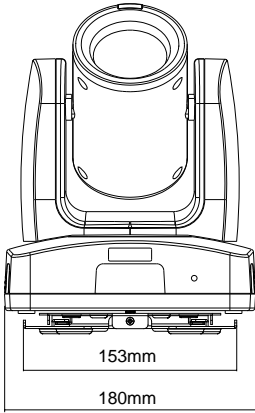
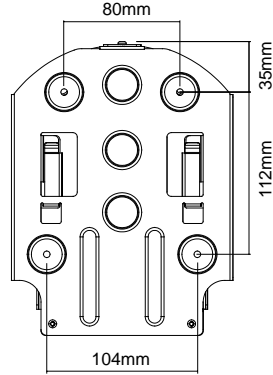
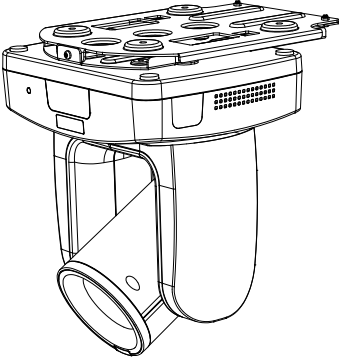

Wall Mount

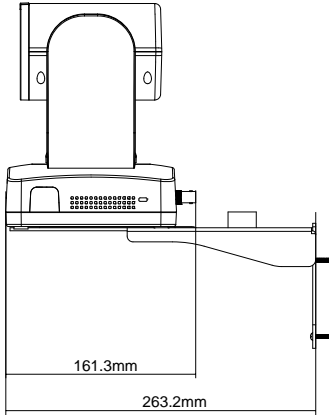
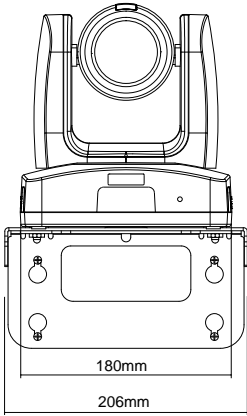
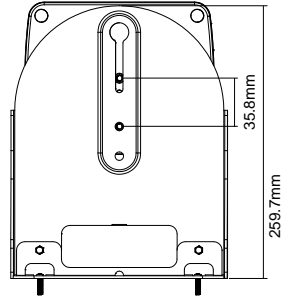
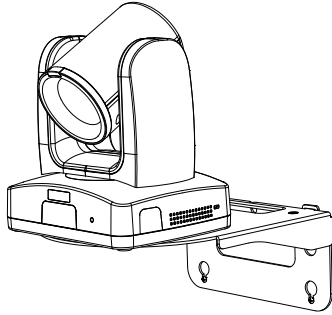
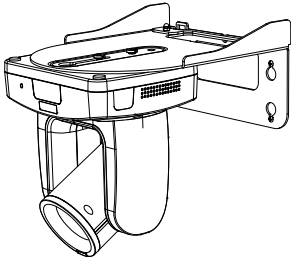

Pan and Tilt Angle

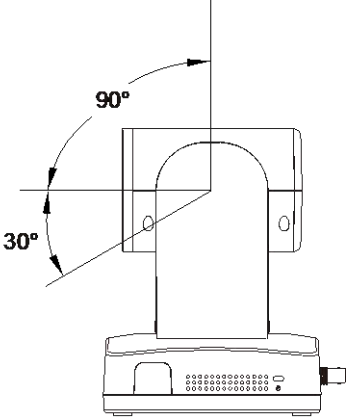
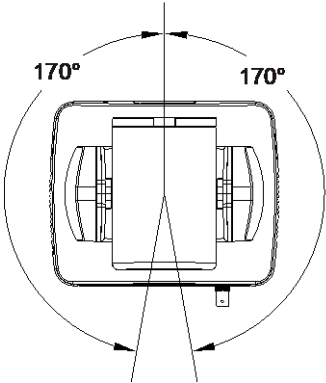

LED Indicators

LED	Status
Flashing blue	Auto Tracking On
Solid blue	Normal
Flashing red	Firmware update
Solid orange	Standby
Flashing orange	Start-up
Flashing purple	Gesture recognition

Device Connection

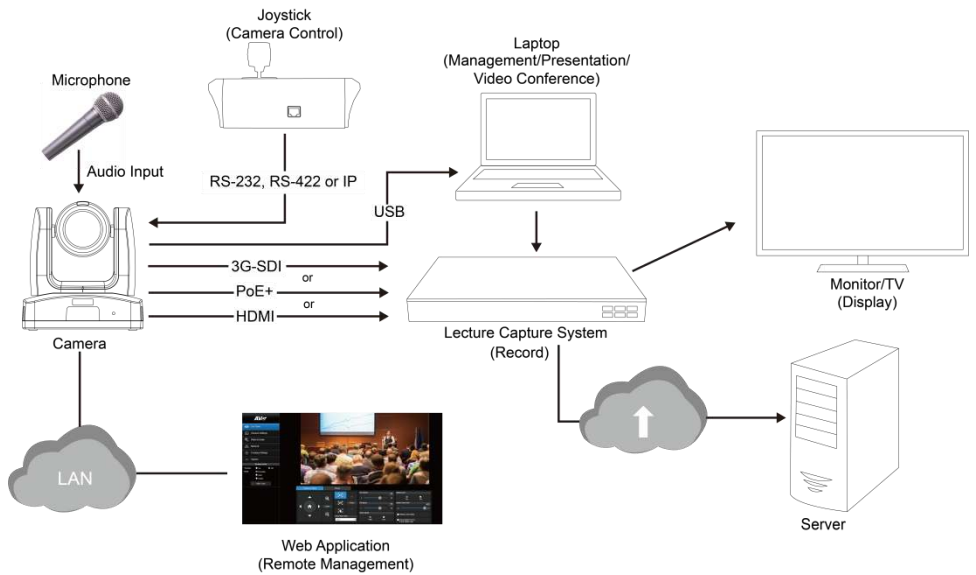

PoE Connection

Connect the camera to the router or switch through the PoE+ port.

[Note] Only support IEEE 802.3AT PoE+ standard.

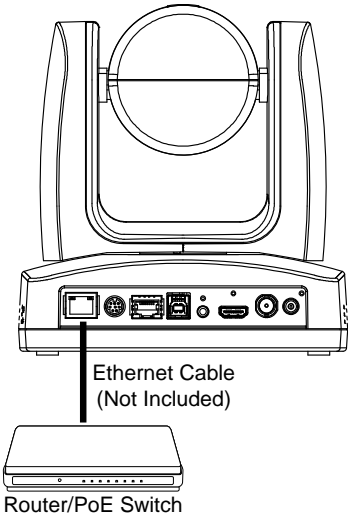

RS-232 and RS-422 Connection

Connect through the RS-232 or RS-422 for camera control.

- RS-232

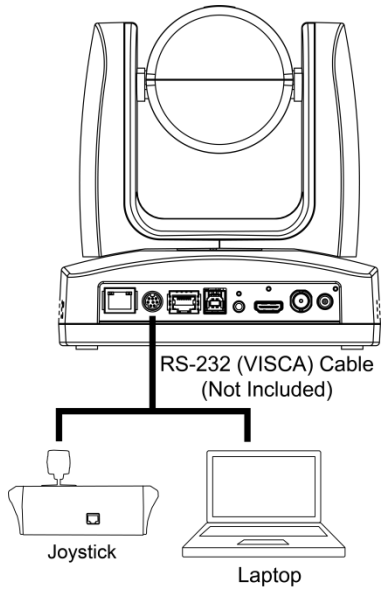

● RS-232 Port Pin Definition

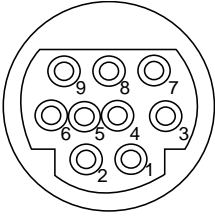

Function	Mini DIN9 PIN #	I/O Type	Signal	Description
VISCA IN	1	Output	DTR	Data Terminal Ready
	2	Input	DSR	Data Set Ready
	3	Output	TXD	Transmit Data
	6	Input	RXD	Receiver Data
VISCA OUT	7	Output	DTR	Data Terminal Ready
	4	Input	DSR	Data Set Ready
	8	Output	TXD	Transmit Data
	9	Input	RXD	Receiver Data
	5	Input	I/O	Detect DIN8/DIN9
---	Shield	---	GND	Ground

● **RS-232 mini DIN9 to mini DIN8 Cable Pin Definition**

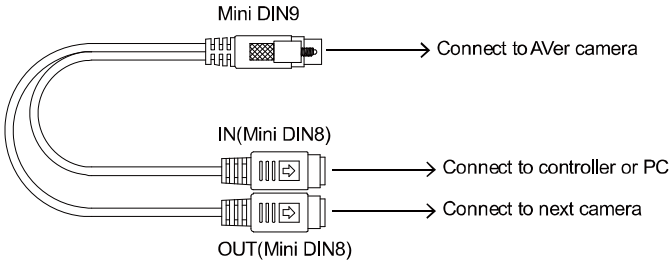

CIRCUITS:

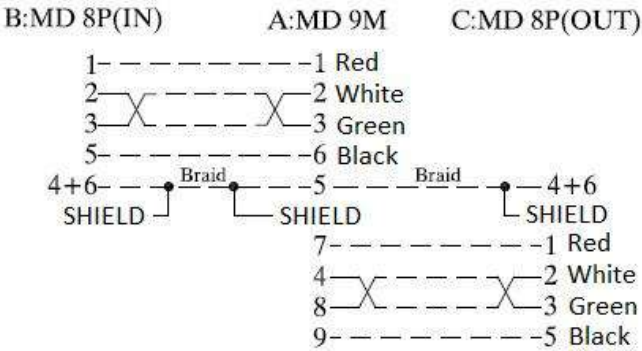

Mini DIN8 Cable Pin Definition

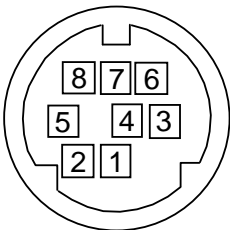

No.	Signal
1	DTR
2	DSR
3	TXD
4	GND
5	RXD
6	GND
7	NC
8	NC

● Din8 to D-Sub9 Cable Pin Definition

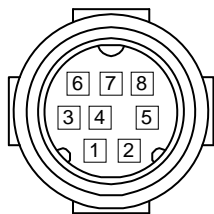
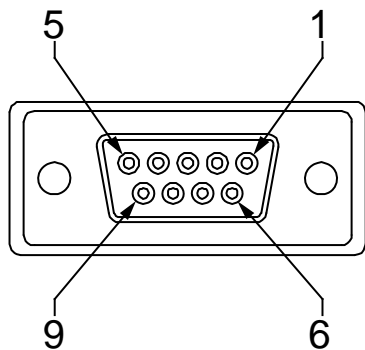

PIN OUT:

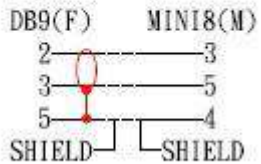

● **RS-422**

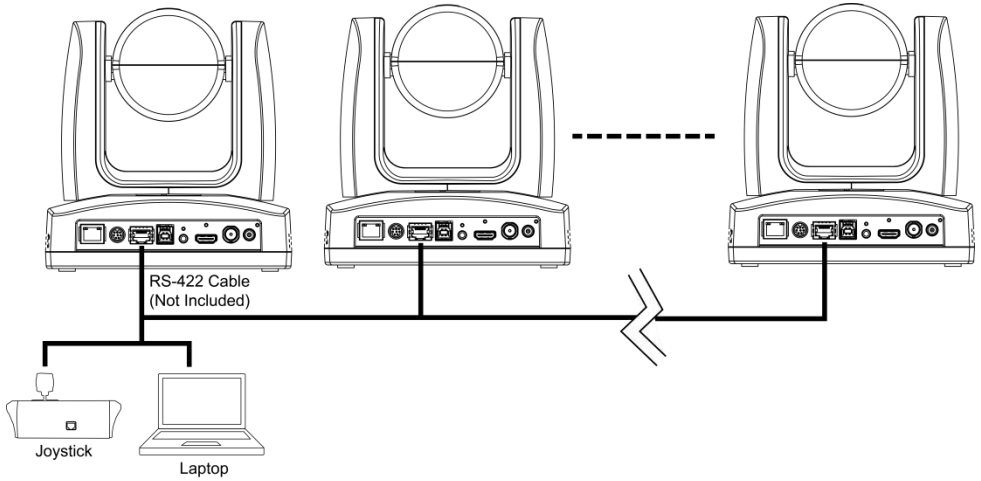

[Notes] Use cat5e splitter for multi-camera connection.

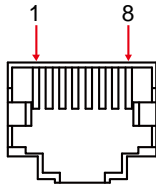

RS-422 Pin			
No.	Pin	No.	Pin
1	TX-	5	TX+
2	TX+	6	RX+
3	RX-	7	RX-
4	TX-	8	RX+

Cat5e splitter pin assignment:

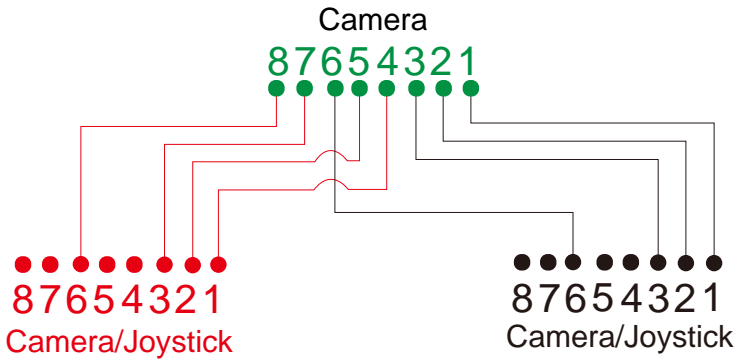

Audio Input Connection

Connect the audio device for audio receiving.

[Notes]

- Line input level: 1Vrms (max.).
- Mic input level: 50mVrms (max.); Supplied voltage: 2.5V.

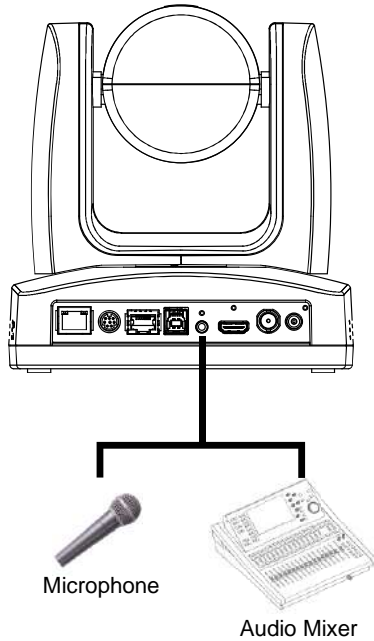

Video Output Connection

- **HDMI**

Use the HDMI cable to connect with monitor or TV for video output.

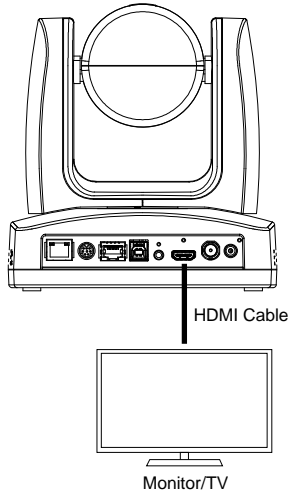

- **3G-SDI**

Connect to 3G-SDI monitor for video output.

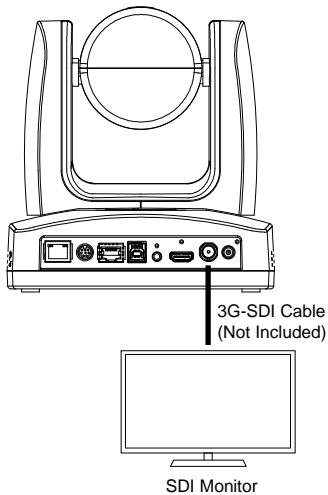

[Notes]

- HDMI and 3G-SDI monitors can be connected to camera and output live video simultaneously.
When the HDMI monitor is well connected before the camera is turned on, the OSD menu will be displayed on HDMI monitor as default.
- The model name with “H” do not have 3G-SDI.

Cable Fixing Plate Installation

1. Secure the cable fixing plate to the camera.
Screws: 3 M2 x 4mm screws (included in the package).

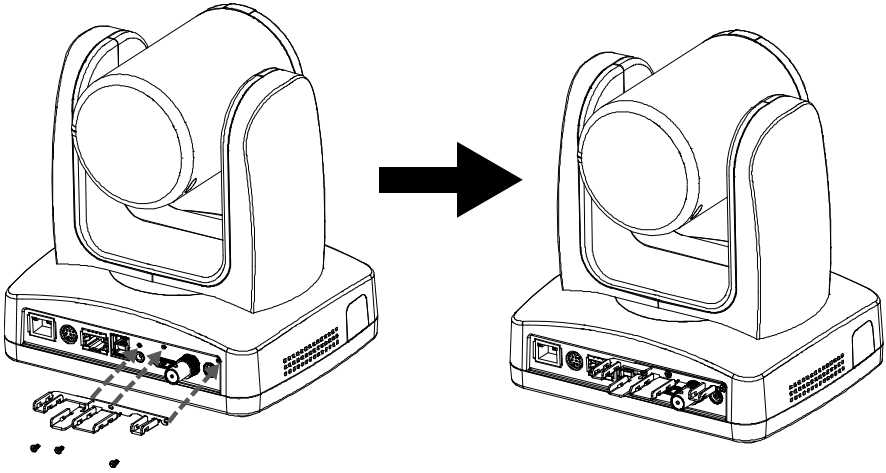

2. Plug in cables.

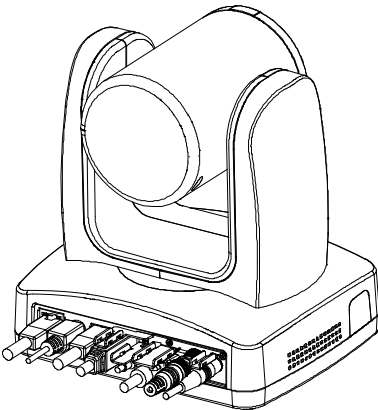

3. Use 4 cable ties to secure the cables and cable fixing plate.

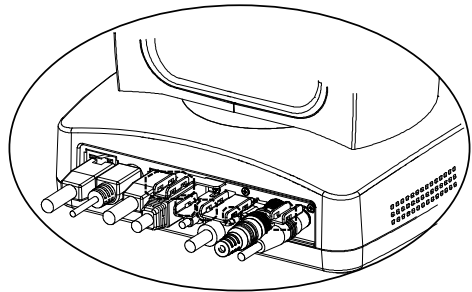

Ceiling Mount Installation

1. Secure the mount bracket on the ceiling.
Screw: 4 screws, M4 x 10mm (Not Included in the package)

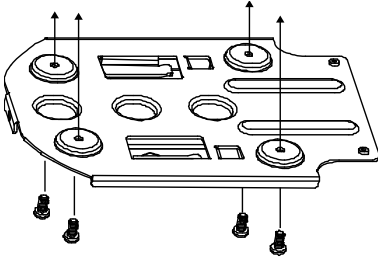

2. Install the mount bracket on the camera.
Screw: 2 screws, 1/4"-20 L=6.5mm (Included in the package)

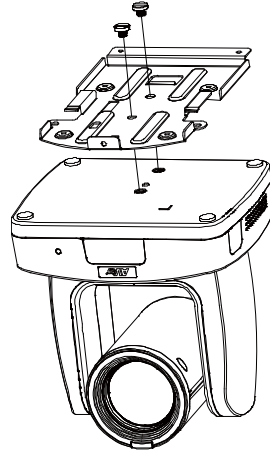

3. Slide the mount bracket with the camera into the mount bracket which secured on the ceiling.

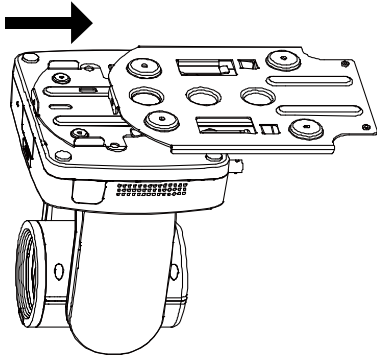

[Notes] Connect necessary cables after sliding the camera into the mount bracket.

4. Secure the camera with screws.
Screw: 3 screws, M3 x 6mm (Included in the package)

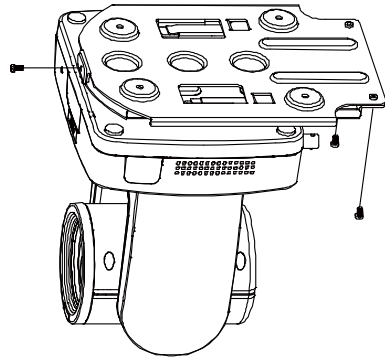

Camera Installation

- **Angle A:** less than 30°
- **Height B:** 2~3m from floor
- **Distance C:** longer than 3m away from podium
- **Position:** center of classroom
- **Distance between the camera and tracking target (presenter):**

Optical zoom ratio ability	Upper body size	Full body size
12X	3~16m	3~28m
16X	3~30m	4~55m
21X	3~40m	4~65m
30X	3~44m	3~76m

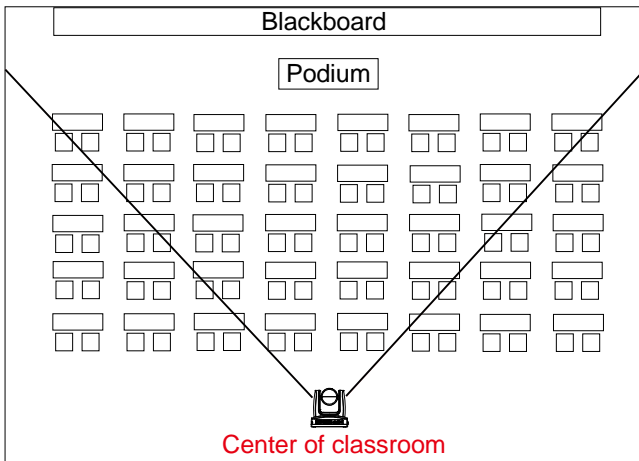
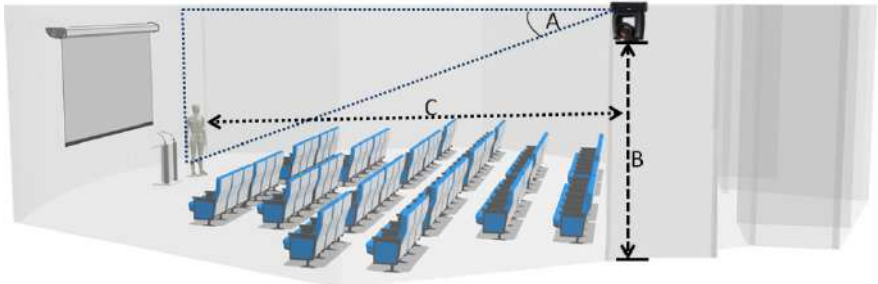

Remote Control

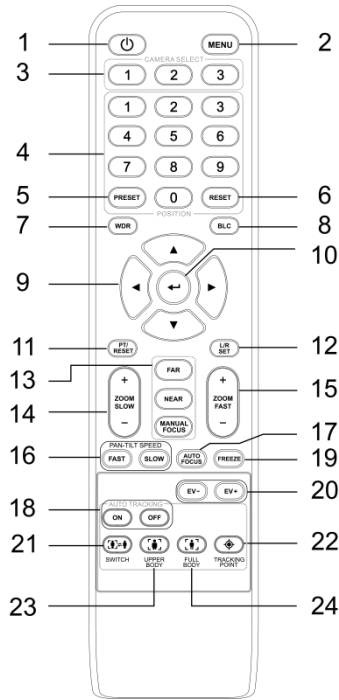

Name	Function
1 Power	Turn the camera on/standby.
2 Menu	Press the button to open OSD menu during HDMI output.
3 Camera Select	Set cameras to CAM1 to CAM3 button. Select a camera to operate.
4 Number Pad	<ul style="list-style-type: none"> ● Set the preset position 0~9. ● Press number button (0~9) to move the camera to pre-configured preset position 0~9.
5 Preset	Press and hold Preset , then short press Number button (0~9) , and then release both buttons to save the preset position.
6 Reset	Press and hold Reset + short press Number button (0~9) , and release all to reset preset position.
7 WDR	Turn on/off Wide Dynamic Range function.
8 BLC	Turn on/off Backlight Compensation.
9 ▲, ▼, ◀, & ▶	Press once for incremental movement or press and hold for continuous pan or tilt.
10 Enter	Access the OSD menu, confirm the selection or make a selection in OSD menu.
11 PT Reset	Reset the Pan-Tilt position.

Name	Function
12 L/R SET	<ul style="list-style-type: none"> ● Invert L/R Pan Direction: Press and hold L/R SET, then short press Position 2, and then release both buttons. ● Reset L/R Pan Direction: Press and hold L/R SET, then short press Position 1, and then release both buttons.
13 Far/Near/MF	Enable manual focus. Use Far/Near to adjust the focus.
14 Zoom +/-	Zoom in/out slowly.
15 Zoom Fast +/-	Zoom in/out fast.
16 Pan-Tilt Speed Fast/Slow	Pan-Tilt speed adjustment.
17 AF	Auto focus.
18 Auto Tracking	Auto Tracking ON/OFF.
19 Freeze	Freeze the live image.
20 EV +/-	<ul style="list-style-type: none"> ● Short press to adjust EV level. ● Long press EV+ to turn on RTMP. ● Long press EV- to turn off RTMP.
21 Switch	Change presenter.
22 Tracking Point	Press the button to enter Tracking Point (Preset Position 1).
23 Upper Body	Focus on the upper body of the presenter.
24 Full Body	Focus on the full body of the presenter.

Set Up the Camera

OSD Menu

You can use the supplied Remote Control to operate the OSD Menu during HDMI output. Press the **MENU** button to call out the On-Screen Display (OSD) menu and use the **▲**, **▼**, **◀**, **▶** and **↵** buttons to operate the OSD menu.



IP Address Setup

Static IP

1. Press the **MENU** button on the remote control to call out the OSD menu.
2. Go to **Network > Static IP**.
[Notes] Turn the DHCP off before setting up static IP (**Network > DHCP > Off**).
3. Select the **IP Address**, **Gateway**, **Netmask** and **DNS** to configure. Press **↵** and use **◀**, **▶** and Number Pad to enter the data.



DHCP

1. Press the **MENU** button on the remote control to call out the OSD menu.
2. Go to **Network > DHCP > On**.



3. After turning the DHCP on, the user can view IP address in **System > Information**.

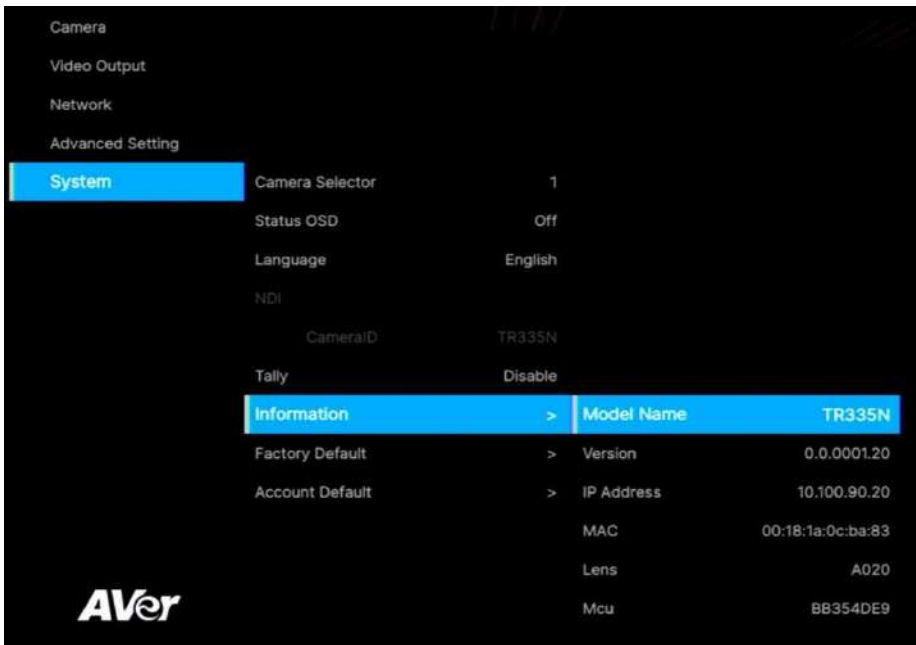

OSD Menu Tree

Camera

Set up camera parameters: Exposure Mode, White Balance, Pan Tilt Zoom, Noise Reduction, Saturation, Contrast, Sharpness, Mirror and Flip.

1 st Layer	2 nd Layer	3 rd Layer	4 th Layer	5 th Layer
Camera	Exposure Mode	Full Auto	Exposure Value	-4/-3/-2/-1/0/1/2/3/4
			Gain Limit Level	24dB/27dB/30dB/33dB/36dB/39dB/42dB
			Slow Shutter	Off/On
		Shutter Priority	Exposure Value	-4/-3/-2/-1/0/1/2/3/4
			Shutter Speed	1/1, 1/2, 1/4, 1/8, 1/15, 1/30, 1/60, 1/90, 1/100, 1/125, 1/180, 1/250, 1/350, 1/500, 1/725, 1/1000, 1/1500, 1/2000, 1/3000, 1/4000, 1/6000, 1/10000
			Gain Limit Level	24dB/27dB/30dB/33dB/36dB/39dB/42dB
	Iris Priority	Exposure Value	-4/-3/-2/-1/0/1/2/3/4	
		Iris Level	F1.6/F2.0/F2.4/F2.8/F3.4/F4.0/F4.8/F5.6/F6.8/F8.0/F9.6/F11/F14/Close	
		Gain Limit Level	24dB/27dB/30dB/33dB/36dB/39dB/42dB	
	Manual	Shutter Speed	Shutter Speed	1/1, 1/2, 1/4, 1/8, 1/15, 1/30, 1/60, 1/90, 1/100, 1/125, 1/180, 1/250, 1/350, 1/500, 1/725, 1/1000, 1/1500, 1/2000, 1/3000, 1/4000, 1/6000, 1/10000
			Iris Level	F1.6/F2.0/F2.4/F2.8/F3.4/F4.0/F4.8/F5.6/F6.8/F8.0/F9.6/F11/F14/Close
			Gain Level	0dB/3dB/6dB/9dB/12dB/15dB/18dB/21dB/24dB/27dB/30dB/33dB/36dB/39dB/42dB
Bright			0, 5-31	-

1 st Layer	2 nd Layer	3 rd Layer	4 th Layer	5 th Layer
Camera	White Balance	Auto	-	-
		ATW	-	-
		Indoor	-	-
		Outdoor	-	-
		One push	-	-
		Manual	R Gain (0-255)	-
		B Gain (0-255)	-	
	Pan Tilt Zoom	Preset Speed	5/25/50/100/ 150/200	-
		Digital Zoom	Off/On	-
		Digital Zoom Limit	x2-x12	-
		Pan/Tilt Slow	Off/On	-
	Noise Reduction	Off/Low/ Medium/High	-	-
	Saturation	0-10	-	-
	Contrast	0-4	-	-
	Sharpness	0-3	-	-
Mirror	Off/On	-	-	
Flip	Off/On	-	-	
LDC*	Off/On	-	-	

*Only certain camera models support LDC function, please refer to the table below.

Supported AVer Cameras:

PTC300V2 Series	PTC500 Series	PTC330 Series	PTC310 Series	PTC115 Series
PTC330UV2 <i>TR333V2</i>	PTC500S <i>TR530</i>	PTC330 <i>TR331</i>	PTC310 <i>TR311</i>	PTC115 <i>TR320</i>
PTC320UNV2 <i>TR323NV2</i>	PTC500+ <i>TR530+</i>	PTC330N <i>TR331N</i>	PTC310U <i>TR313</i>	PTC115+ <i>TR320+</i>
PTC320UV2		PTC330U <i>TR333</i>	PTC310H	
			PTC310N <i>TR311N</i>	
			PTC310UN <i>TR313N</i>	
			PTC310HN	

V3 Series

TR335

TR335N

*US model name in italics.

Video Output

Select video resolution (2160p is only supported on certain models).

1 st Layer	2 nd Layer	3 rd Layer
Video Output	Theme Mode	Standard/Zoom/Teams/(NDI)
	Frequency	50Hz/59.94Hz/60Hz
	Resolution	2160P/30, 2160P/60, 1080P/60, 1080P/30, 1080I/60, 720P/60

Network

Set up IP mode – DHCP or Static IP.

1 st Layer	2 nd Layer	3 rd Layer
Network	DHCP	Off/On
	Static IP	IP Address, Gateway, Mask, DNS

Advanced Setting

1 st Layer	2 nd Layer	3 rd Layer	4 th Layer
Advanced Setting	Audio	Input Type	Line In/Mic In
		Audio Volume	0-10
	Control	Serial Port	RS-232/RS-422
		Protocol	VISCA/PELCO D/PELCO P
		Camera Address	1-7
		Baud Rate	4800/9600/38400
	Tracking	Off/On	-
	Tracking Mode	Presenter	-
		Zone	-
		Hybrid	-

System

- **Status OSD:** Enable/disable Preset status (Save Preset, Call Preset, Cancel Preset) display on the screen.
- **Camera Selector:** Set the camera ID 1~3 for using remote control on multiple cameras control (also see No.3 Camera Select in Remote Control chapter).
- **NDI:** Enable/disable NDI function.
- **Tally:** Enable tally function.

1 st Layer	2 nd Layer	3 rd Layer
System	Camera Selector	1-3
	Status OSD	Off/On
	Language	English/繁體中文/日本語/简体中文/한국어/ Tiếng Việt
	NDI	Off/On
	Tally	Disable/Enable
	Information	Model Name/Version/IP Address/MAC/Lens/Mcu
	Factory Default	Off/On
	Account Default	Off/On

Web Setup

Connect the camera from a remote site through the internet.

Access the Web Interface of the Camera

To access the camera Web interface, you have to use **AVer IPCam Utility** or **AVer PTZ Management** software to search camera IP address.

Access the Camera via AVer IPCam Utility

To use **AVer IPCam Utility** to find the camera IP address:

1. Download the **AVer IPCam Utility** from <https://www.aver.com/Downloads/search?q=AVer%20IPCam%20Utility%20for%20Camera%20IP%20Searching> and launch the application.
2. Click **Search** to view all available devices on the screen.
3. Click to select a camera from the list to view the camera info in the Settings field.
4. The default network of the camera is Static IP (192.168.1.168) and default ID/Password are **admin/admin**. If you want to configure the network to DHCP, enter the ID/Password in the **Login** field, select the “camera model” on the list, select “DHCP” and then click the **Apply** button.

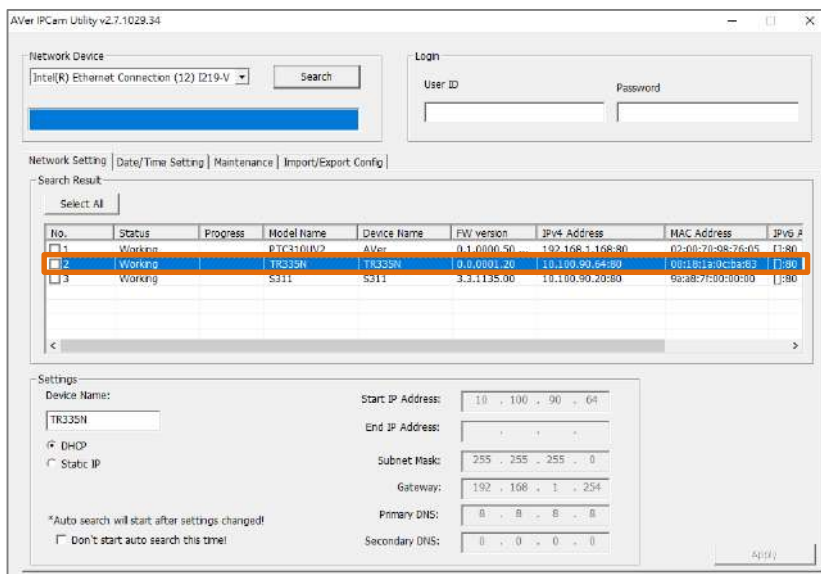

5. To access the Web interface, double-click on the IP address in the IPv4 Address column.
For the first-time user, you will be prompted with a Login window to change the ID and password.



6. Login with the new ID/Password, the Web interface of the camera will be displayed (Chrome browser). Please refer to [<Live View>](#) chapter for more details.

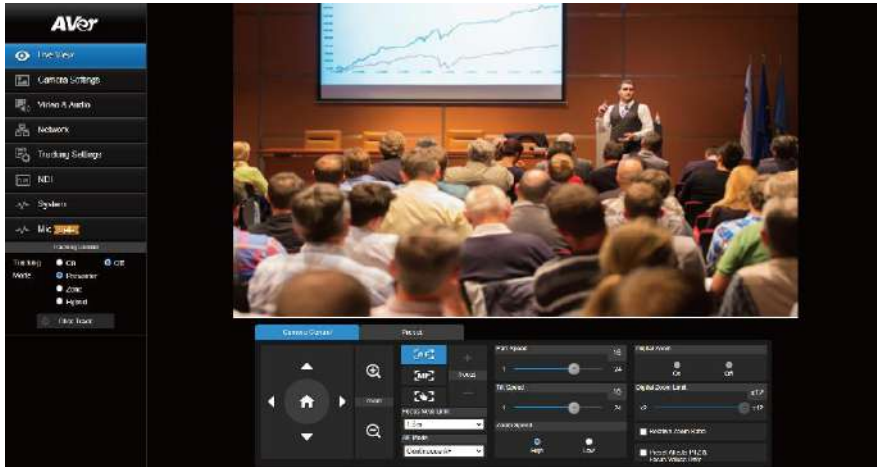

[Notes] If IPCam utility cannot find the camera, please check the following:

- Please make sure the Ethernet connection of the camera is well connected.
- The camera and PC (IPCam Utility) are in the same LAN segment.

Accessing the Camera via AVer PTZ Management

Use AVer PTZ Management to find the IP address of your cameras, follow the steps below.

1. Download the AVer PTZ Management software from <https://www.aver.com/download-center>.
2. Download the Windows program and install it.
3. Set up the user ID and password, and log in to the software (default User Name/Password: admin/admin).

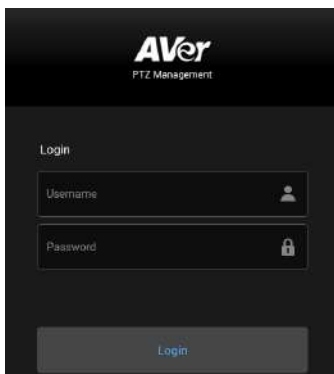

4. On the Main page of PTZ Management, click **Setup > Add > click Auto Search**. The cameras connected on the same LAN with the computer will be displayed.
5. Click on the camera and enter the camera ID and Password to add the camera to the device list (default ID/Password are **admin/admin**). Click **Go to Web** to access the camera web application.

Live View

You can control the camera and operate the Preset functions using this page.

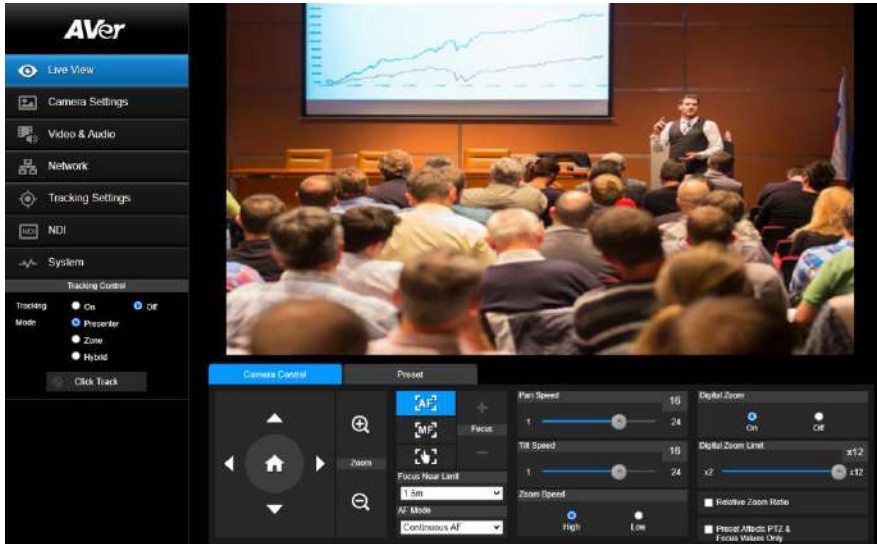

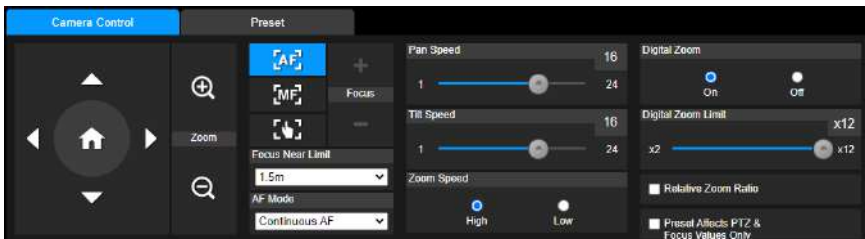

Camera Control

Click the **Camera Control** tab to display the panel below for operation.





● Pan-Tilt-Zoom Control

Use the directional buttons to navigate the camera view. Adjust the **Pan Speed** and **Tilt Speed** if necessary.

Use  and  to zoom in or zoom out the live image. You can also select **Zoom Speed** (**High/Low**).

Click  to go back to home (default) position.

● Focus

Item	Description
Auto Focus 	Click to perform the auto focus.
Manual Focus 	Click to manually adjust the focus. You can use the Focus + and Focus - buttons to adjust the focus.
One-push Focus 	Click to automatically adjust the focus right away.
Focus Near Limit	Set the focus distance limit.
AF Mode	<p>If Auto Focus is selected, you can further set up the AF Mode.</p> <ul style="list-style-type: none">● Continuous AF: The camera will automatically adjust focus all the time.● AF Trigger after PTZ: The camera will automatically adjust focus each time after performing the pan, tilt or zoom functions.

● Digital Zoom



Item	Description
Digital Zoom	Select On or Off to enable or disable the function.
Digital Zoom Limit	Adjust the digital zoom from x2 to x12.
Relative Zoom Ratio	Turn on or off the function. If you turn on Relative Zoom Ratio, the pan/tilt speed will be automatically adjusted based on the zoom ratio. The more the zoom ratio, the slower the pan/tilt speed.
Preset Affects PTZ & Focus Values Only	Turn on this function to save only the value of pan, tilt, zoom and focus for the configured preset points.

Preset

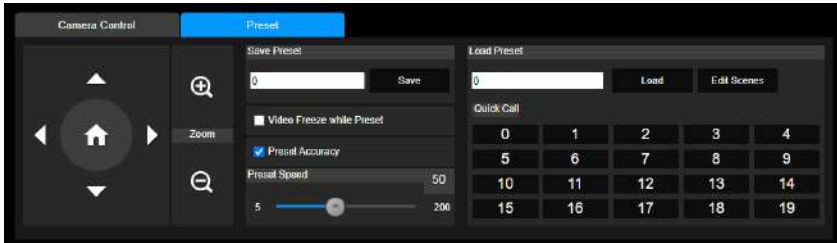
Click the **Preset** tab to display the panel below. You can edit and operate the preset positions.



To set up preset positions:

1. Go to **Live View > Preset**.
2. Use the directional buttons to navigate the camera view. Optionally use  and  to zoom in or zoom out the images.
3. Enter a preset number (0~255) in the **Save Preset** column and click **Save** to save the position.

To move camera to preset positions:

1. Enter a preset number (0~255) in the **Load Preset** column or click a preset number (0~19) in the **Quick Call** section.
2. Click **Load**, the camera will move to the preset position.

When operating the go to preset positions, you can optionally adjust the **Preset Speed** or turn on or off the **Video Freeze while Preset** function.

- **Video Freeze with Preset:** When you turn on this function, the camera will not display the view along the path when moving from one position to another. The camera will only display the view of the positions.
- **Preset Speed:** Drag the slider to adjust the moving speed from one preset position to another. (5~200)

To customize camera functions at each preset positions:

1. Go to **Live View > Preset > Edit scenes**.
2. Click **Scenes 0~9** to add up to 10 CGI commands (follow the format of <https://username:password@URL>) for each scene.
3. Select a Scene from the Scenes drop-down list to pair **Preset 0~9** with **Scene 0~9**.
4. Click **Append** to add CGI commands, and click **Remove** to delete CGI commands. When finished, click **Save**.

Camera Settings

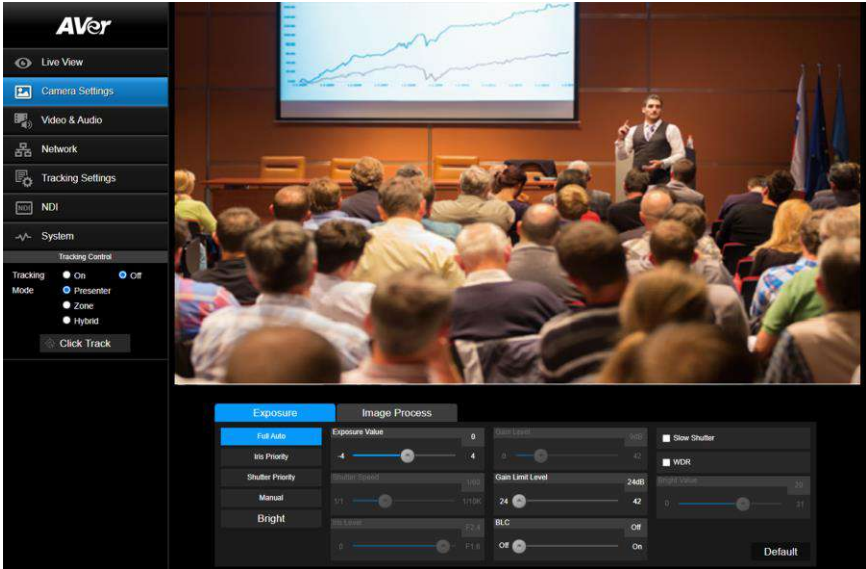

Exposure

Click the **Exposure** tab to display the panel below for configuration.

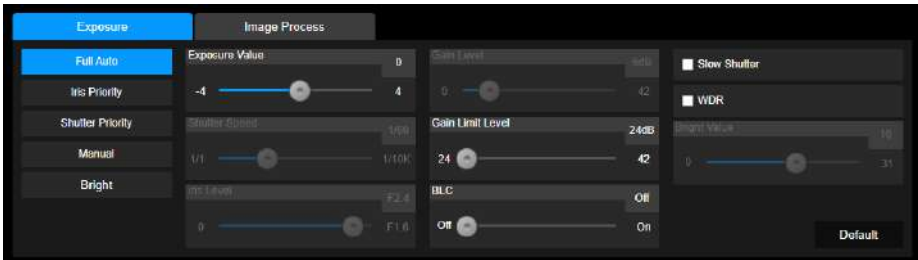

Item	Description
Exposure Mode	Options include Full Auto , Iris Priority , Shutter Priority , Manual and Bright . Select an exposure mode and optionally adjust the value of Exposure Value , Gain Level , Shutter Speed , Gain Limit Level , Iris Level , BLC and Bright Value .
Slow Shutter	Select the checkbox to let more light enter the lens.
WDR	Select the checkbox to turn on Wide Dynamic Range mode for more vivid camera view.

Click **Default** to reset the **Exposure** settings to factory default.

Image Process

Click the **Image Process** tab to display the panel below for configuration.

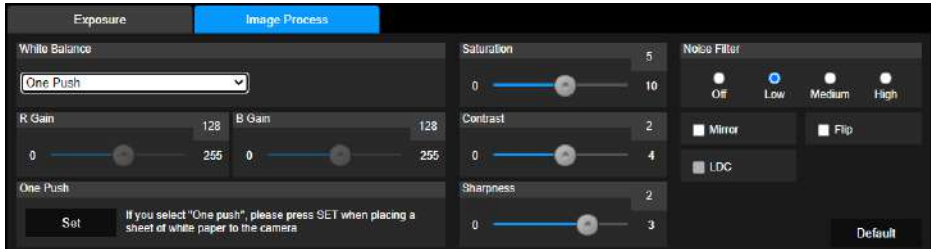

Item	Description
White Balance	Options include AWB , ATW , Indoor , Outdoor , One Push and Manual . <ul style="list-style-type: none">● Select Manual to adjust the R Gain and B Gain manually.● Select One Push, and click Set in the One Push field when placing a white paper sheet in front of the camera lens.
Saturation	Drag the slider to adjust the value.
Contrast	Drag the slider to adjust the value.
Sharpness	Drag the slider to adjust the value.
Noise Filter	Select from Off , Low , Middle or High to adjust the noise filter.
Mirror	Select the checkbox to flip the camera view horizontally.
Flip	Select the checkbox to flip the camera view vertically.
LDC	Turn on or off Lens Distortion Correction. Turn on this function to automatically correct image distortion caused under certain zoom level.

Video & Audio

You can configure video and audio settings on this page.

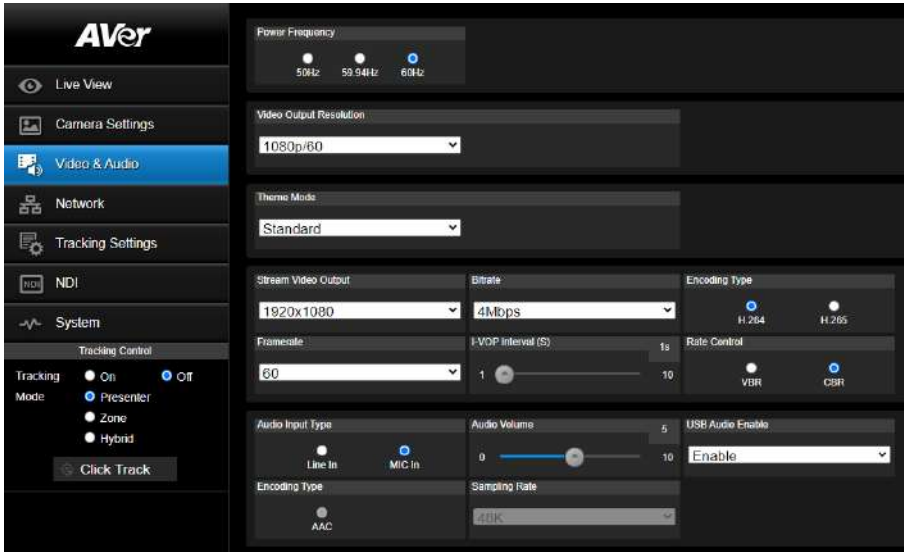

● Video and Audio Settings

Item	Description
Power Frequency	Select from 50Hz , 59.94Hz or 60Hz based on your region.
Video Output Resolution	Select a resolution to display on your video output device.
Theme Mode	Select to a theme mode for your video output from the drop-down list.
Stream Video Output	Select a stream resolution on live view from the drop-down list.
Bitrate	Select a bitrate from the drop-down list.
Framerate	Select a framerate for live stream – 1 , 5 , 15 , 20 or 30 for power frequency 59.94Hz or 60Hz ; 1 , 5 , 15 , 20 or 25 for power frequency 50Hz .
I-VOP Interval (S)	Drag the slider to set the value from 1s to 10s .
Encoding Type (video)	Select H.264 or H.265 to encode streaming video.
Rate Control	Select VBR or CBR .
Audio Input Type	Select to input audio by Line in or Mic in .
Audio Volume	Drag the slider to set the volume from 0 to 10 .

Encoding Type (audio)

Select to encode audio.

Sampling Rate

Select a sampling rate from the drop-down list.

USB Audio Enable

Select from the drop-down list to turn on or off the setting.

Network

You can configure network settings on this page.

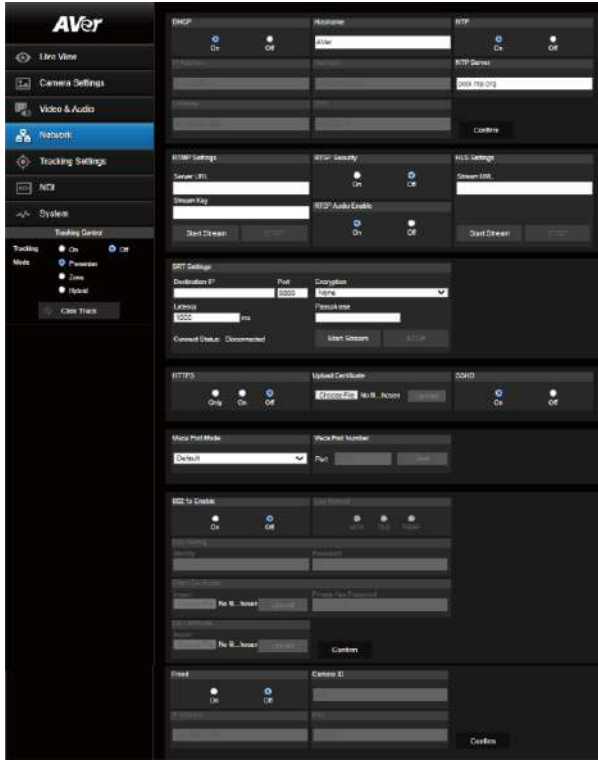

Item	Description
DHCP	<p>You can set up the network to DHCP or Static IP.</p> <ul style="list-style-type: none"> ● DHCP: Select On to assign the related IP settings with the camera automatically. Click Confirm to save the settings. ● Static IP: Select Off to manually enter the IP Address, Netmask, Gateway and DNS. Click Confirm to save the settings.
Hostname	The default Hostname is TR335N. You can change the hostname to be displayed on other devices, e.g. IP router.
NTP	<p>Select to turn the function On or Off.</p> <p>When NTP is On, enter NTP Server into the text box.</p>

Change the **RTMP** settings to transfer camera stream to the broadcasting platform, e.g. YouTube.

To set up the RTMP settings:

RTMP Settings

1. Enter the **Server URL** and **Stream Key** of the broadcasting platform. Please refer to the instruction of the broadcasting platform you use to get the RTMP server URL and stream key.
2. Click **Start Stream**, the camera stream will direct you to your broadcasting platform.
3. To stop broadcasting, click **STOP**.

Change the **RTSP** settings to display camera streams on applications such as VLC, PotPlayer or Quick Time to use RTSP streaming.

To enable RTSP:

RTSP Security

1. Select **On** in the **RTSP Security** field.
2. Select **On** in the **RTSP Audio Enable** field if you want to transfer audio.
3. On your application, enter the **RTSP** (ex: rtsp://192.168.1.100/live_st1) and ID/Password of the camera.

HLS Settings

To transfer the HLS streaming, enter the **Stream URL** and click **Start Stream**. Click **STOP** to stop transferring.

SRT Settings

Enter **Destination IP**, **Encryption**, **Latency** and **Passphrase**.

When finished, click **Start Stream**.

Click **STOP** to stop streaming.

HTTPS

Turn on HTTPS to establish a secure connection between your browser and your camera.

To turn on HTTPS access on your camera:

1. Create a SSL certificate file for encryption and decryption.
2. In the HTTPS setup field, select **On** and then click **Choose File** to select the certificate file.
3. Click **Upload**.

Click **Choose File** to upload a SSL certificate (must be in the PEM format) to PTC/PTZ/DL cameras.

To create this format:

Upload Certificate

1. Prepare your certificate, intermediate certificates, and the CA root in a base-64 encoded format. Additionally, prepare the private key in the PKCS#8 format (should be unencrypted).
2. Combine the certificates and the private key in a specified order to create the PEM format:

-----BEGIN PRIVATE KEY-----

.....

-----END PRIVATE KEY-----

-----BEGIN CERTIFICATE-----

.....

-----END CERTIFICATE-----

After the preparation, upload the SSL certificate.

SSHD	Select to turn the function On or Off .
Visca Port Mode	Select from the drop-down list to set Visca Port Mode . After selected, enter Visca Port Number .
802.1x Enable	Select to turn on or off the function.
Eap Method	After turning on 802.1x Enable function, select from MD5 , TLS and PEAP to set up the function.
Eap Setting	After turning on 802.1x Enable function, enter Identify and Password . According to your Eap Method, import Client Certificate , Private Key Password , CA Certificate . When finished, click Confirm .
FreeD	Turn on FreeD protocol to send camera positioning data to a virtual reality production system. When FreeD is on, enter TR335N Camera ID , and the IP Address and Port of the device receiving positioning data.

● SRT Settings

Example 1 vMix:

Set the workstation and the TR335N camera in the same network. Check the workstation's IP address (Destination IP). Example:

```
C:\WINDOWS\system32\cmd.exe
Windows IP Configuration

Wireless LAN adapter Local Area Connection* 1:

    Media State . . . . . : Media disconnected
    Connection-specific DNS Suffix  . :

Ethernet adapter Ethernet:

    Connection-specific DNS Suffix  . :
    Link-local IPv6 Address . . . . . : fe80::8013:bd79:8b8c:2339%21
    IPv4 Address. . . . . : 192.168.1.10
    Subnet Mask . . . . . : 255.255.255.0
    Default Gateway . . . . . :

Wireless LAN adapter Wi-Fi:

    Connection-specific DNS Suffix  . : aver.com
    Link-local IPv6 Address . . . . . : fe80::685d1527-1f05:a45e%11
    IPv4 Address. . . . . : 10.100.200.67
    Subnet Mask . . . . . : 255.255.255.0
    Default Gateway . . . . . : 10.100.200.254

Ethernet adapter Bluetooth Network Connection:
```

Select SRT (Listener) from Stream Type in vMix Input Select window.

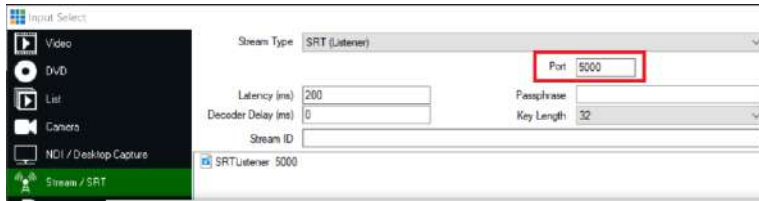

Enter the information into the SRT Settings TR335N web interface, then click on **Start Stream**, **Connect Status** shows **Connected**.



Example2 OBS (Open Broadcaster Software):

Set the workstation and the TR335N camera in the same network. Check the workstation's IP address (Destination IP). Example:

```
Connection-specific DNS Suffix . : aver.com
Link-local IPv6 Address . . . . . : fe80::f1dc:bcda:87bd:acle%12
IPv4 Address. . . . . : 10.100.105.127
Subnet Mask . . . . . : 255.255.255.0
Default Gateway . . . . . : 10.100.105.254
```

Open OBS, add a scene, add a source, enter `srt://Work Station IP:port?mode=listener`
Example: `srt://10.100.105.127:8889?mode=listener`

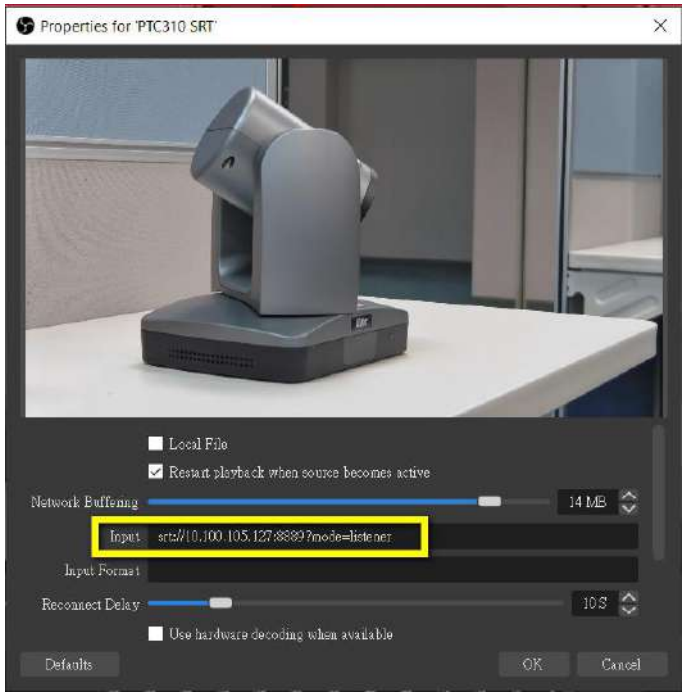

[Notes] If there is no image, please try right-click on the source->Transform->Fit to screen to re-scale image.

Tracking Settings

You can set up the tracking modes and use the **Tracking Control** panel to perform the tracking function. You can also turn on Gesture control to use your hands to control certain camera functions.

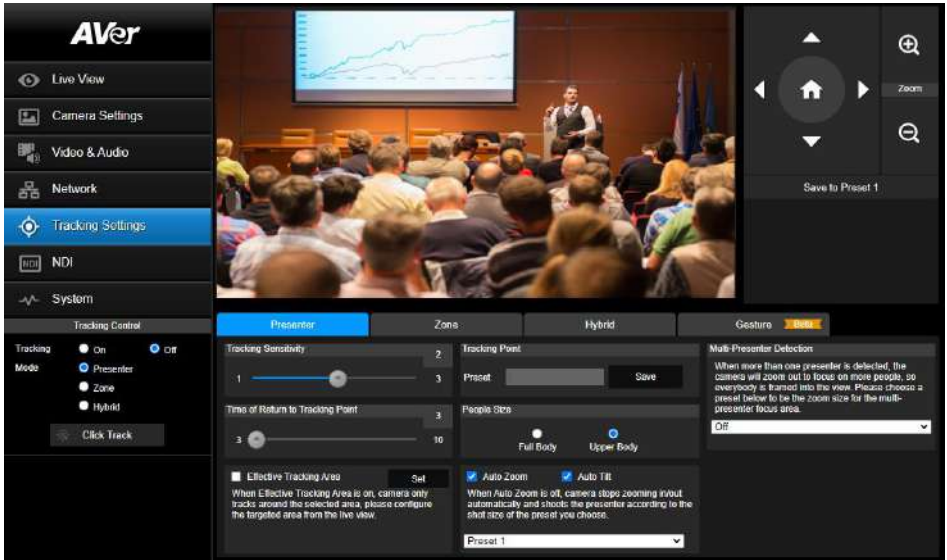

Tracking Mode	Description
Presenter	Camera starts tracking when a presenter appears in the camera view. Select Upper Body for People Size , the camera will focus on the targeted presenter with less background. If the presenter is out of the camera view, the camera will return to the pre-configured Tracking Point .
Zone	Camera focuses on the pre-configured zones (preset areas) while tracking the presenter.
Hybrid	You can benefit from the advantages of both the Presenter and Zone modes. The camera will start tracking when a presenter is detected in the camera view. If the position where a presenter enters is pre-configured as a tracking zone (preset area), the camera will activate as Zone tracking.

To perform the tracking function, you can:

- On the camera web application, click **Tracking Settings** to set the tracking modes.
- Go to **Tracking Control** panel > select from **Presenter**, **Zone** and **Hybrid** mode. Optionally click the **Click Track** button if you want to select a new target presenter to track.

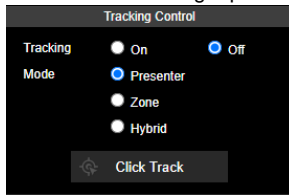

Click the **Click Track** button, the target presenter will be highlighted with a red frame, while the other detected presenters will be highlighted with blue frames.

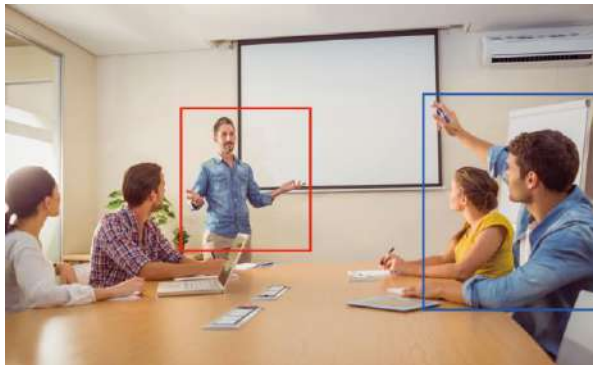

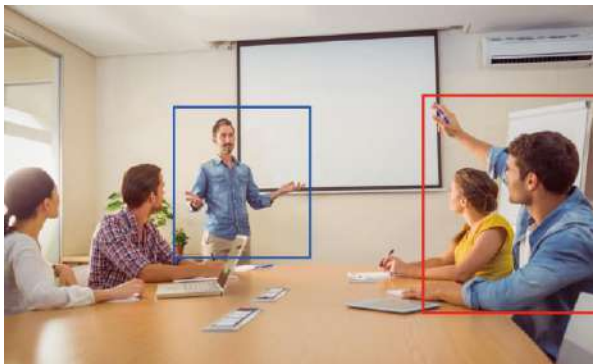

Click on the presenter with a blue frame, the camera will change focus to the presenter you click.

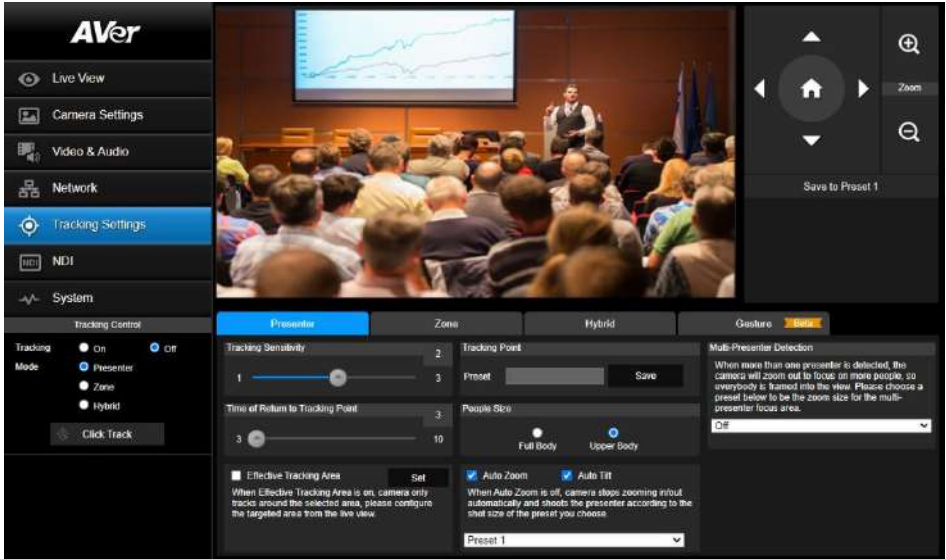

Presenter Mode

Camera will start tracking when the presenter enters the camera live view.



Item	Description
Tracking Control	Click to turn on or off, and select a tracking mode.
Tracking Sensitivity	Drag the slide bar to adjust the sensitivity of the tracking function.
Tracking Point	Use the directional buttons,  and  to adjust the camera to a Tracking Point (preset position). Click Save to Preset 1 to save the Tracking Point . When no one is in view, the camera will go back to the Tracking Point (preset position).
Time of Return to Tracking Point	Set the idle time (sec.) for the camera to return to the Tracking Point . Drag the slider to adjust the value.
People Size	Select to track the presenter in Full Body (entire body) or Upper Body (up to 60% of body).
Effective Tracking Area	Set up a tracking area (optional). When Effective Tracking Area function is on, the camera only tracks around the selected area. Select the checkbox to enable the function and click the Set , a red frame appears in the preview window. Drag the upper-left or the lower-right corner of the red frame to adjust the tracking area.

Auto Zoom	When Auto Zoom is off, the camera stops zooming in/out automatically but keep the zoom size based on the preset point selected from the drop-down list below.
Auto Tilt	Select the checkbox to turn on the Auto Tilt function.
Multi-Presenter Detection	When more than one presenter is detected, the camera will zoom out to frame every presenter in the camera view. To set up Multi-Presenter Detection, please refer to <Configuring Multi-Presenter Detection> .

Configuring Multi-Presenter Detection

Set up a preset position for Multi-Presenter Detection. Ensure the camera view of this position fully covers the area where multiple presenters may appear. This preset position will be triggered when multiple presenters are detected.

To set up the preset position, go to **Live View > Preset**.

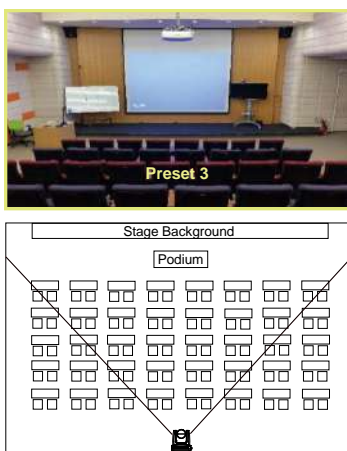

To configure Multi-Presenter Detection:

1. Go to **Tracking Settings > Presenter** setup page > select a pre-configured preset position (e.g. Preset 3) from the **Multi-Presenter Detection** drop-down list to turn on **Multi-Presenter Detection** function. Presenters appearing within the current camera view will trigger the **Multi-Presenter Detection**.
2. Drag the slider of **Time of Return to Tracking Point** to adjust the duration when the camera loses track of the detected presenters and moves back to the selected preset point. By default, the dwell time set up with 3 second.

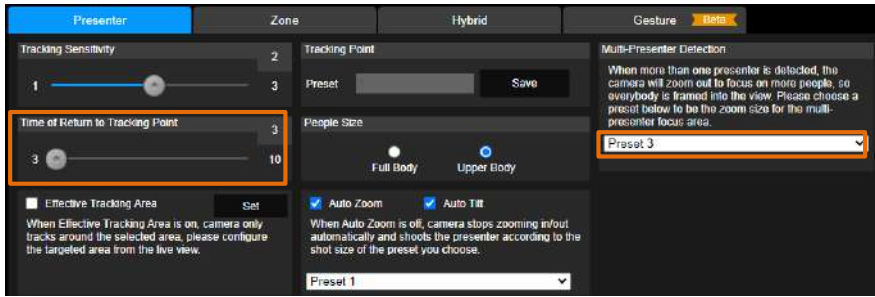

- When the **Presenter** tracking function is on, the **Multi-Presenter Detection** will be activated. To turn on the **Presenter** tracking, please refer to [<Tracking Settings>](#).
- To turn off the **Multi-Presenter Detection** function, go to **Tracking Settings > Presenter** setup page > select **Off** from the **Multi-Presenter Detection** drop-down list.

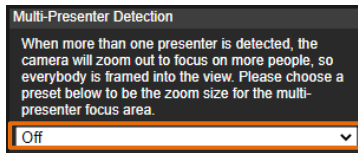

Multi-Presenter Detection will be triggered



Preset Position bundled with Multi-Presenter Detection Current Camera View

Multi-Presenter Detection will not be triggered



Preset Position bundled with Multi-Presenter Detection Current Camera View

For example, when there is one presenter detected, the camera will perform single-presenter tracking, in which the camera view will focus on the presenter.

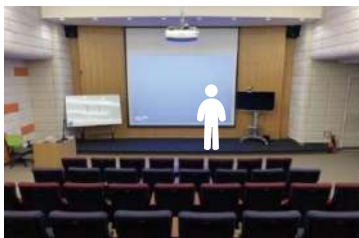

Meanwhile, when there is another presenter appears within the current camera view and then detected by the camera, the camera will be triggered to the pre-configured preset position.

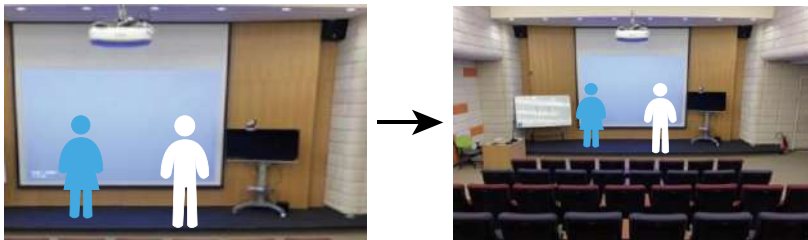

You can also use the supplied Remote Control to quickly set up the **Presenter Mode**.

1. Adjust the camera view properly and then save to preset 1 as the initial position.
2. Press **Auto Tracking ON** to turn on the function.
3. Press **Upper Body** to track the presenter with a closer view (up to 60% of body), or **Full body** to track the entire presenter in the view.
4. Press **SWITCH** to switch between presenters. Initially the camera tracks the one who is in the center of view. Every switch follows the sequence: left to right, then back to far left one in the camera view (see picture below).
5. To see which presenter is being tracked, press and hold **FREEZE** button to call/cancel engineering mode while tracking, you will see the tracked presenter is framed with a green box (Only during HDMI output).

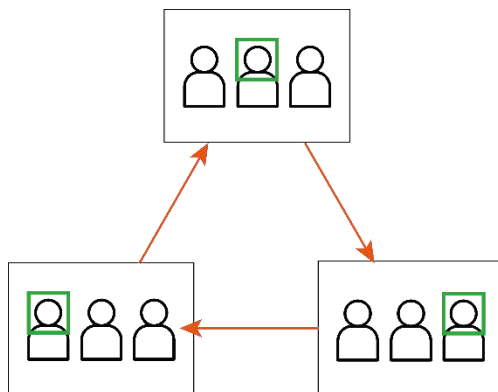

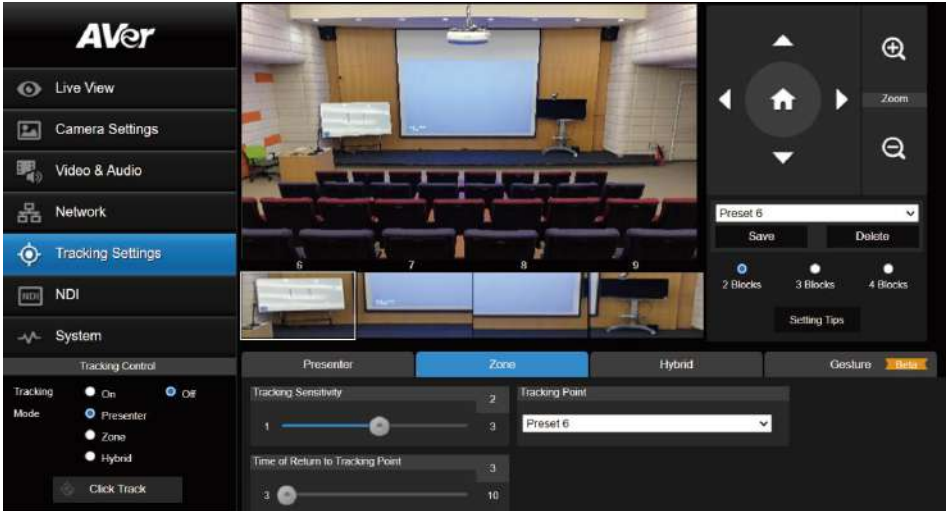

Zone Mode

Set up the block areas for the camera to detect the presenter and track the presenter when the presenter appears within the pre-configured areas (preset areas).



To configure the preset areas:

1. Select the block number (**2 Blocks**, **3 Blocks** or **4 Blocks**) you want to configure for the preset positions. You can set up to 4 preset positions.
2. Select a preset number from the drop-down list (**Preset 6 ~ 9**).
3. Use the directional buttons,  and  to move the camera to the desired position.
4. Click **Save** to save the position to the selected preset number. A preset thumbnail will be displayed below the preview window.

[Notes] To ensure smooth transition while tracking the presenter, please **OVERLAP** the set up preset areas. Do not separate the preset areas.

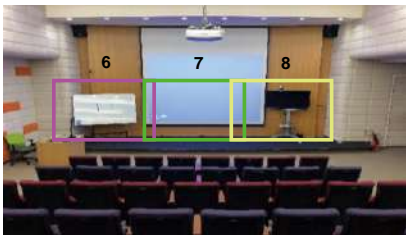

Ensure to overlap the preset areas

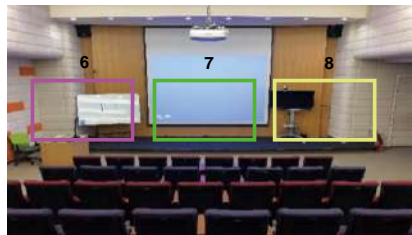

Do not separate the preset areas

Set up the preset view to clearly see the presenter at least complete half body (60% upper body) to ensure tracking accuracy. Make sure there is no any other human-outline poster/TV/monitor in the background. The result of the **Zone Mode** is illustrated as below.



1. Adjust the value or turn on the functions below.

Item	Description
Tracking Sensitivity	Drag the slider to adjust the sensitivity of the tracking function.
Tracking Point	When losing tracking target, the camera will go back to the Tracking Point (preset position). To set up the Tracking Point , refer to step 1.
Time of Return to Tracking Point	Set the idle time (sec.) for the camera to return to the Tracking Point . Drag the slider to adjust the value.

2. You can also use the supplied Remote Control to quickly set up the **Zone Mode**. Press the **Auto Tracking "On"** button to turn on tracking function. Long press **Tracking Point** to switch tracking mode from **Presenter Mode** to **Zone Mode** (the hotkey supported at firmware v0.0.0000.21 or later).
3. By default, **2 Blocks** has initially selected if you use the Remote Control to set up the **Zone Mode**. If you want to configure more blocks, you will have to use the Web interface for setup.
4. Adjust the camera view properly and then save to preset 6 and preset 7. By default, preset 6 is initially selected to be the first position to set up.

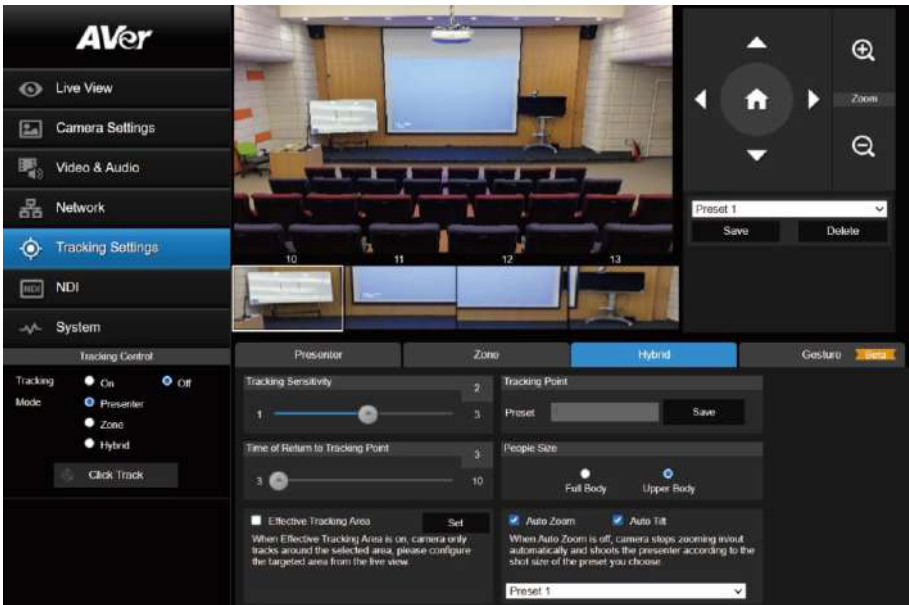

Hybrid Mode

You can benefit from the advantages of both the **Presenter** and **Zone** modes. The camera will start tracking when a presenter is detected in the camera view. If the position where a presenter enters is pre-configured as a tracking zone (preset area), the camera will activate as Zone tracking.



Set up a **Tracking Point**. When losing tracking target, the camera will go back to the **Tracking Point** (preset position).

To set up the Tracking Point:



1. Select **Preset 1** from the drop-down list.
2. Use the directional buttons,  and  to adjust the camera view.
3. Click **Save** to save this preset point as the **Tracking Point**.



To better perform the **Hybrid Mode**, DO NOT overlap the zones (preset areas) nor configure the zones close to each other. It's recommended to leave some distance among the zones.



Adjust the value or turn on the below functions:

Item	Description
Tracking Sensitivity	Drag the slider to adjust the sensitivity of the tracking function.
Tracking Point	<ol style="list-style-type: none"> 1. Select a preset number from the drop-down list (Preset 10 ~ 13). 2. Use the directional buttons,  and  to move the camera to the desired position. 3. Click Save to save the position to the selected preset number. A preset thumbnail will be displayed in the preview window below.
Time of Return to Tracking Point	Set the idle time (sec.) for the camera to return to the Tracking Point . Slide the bar to adjust the value.
People Size	Select to track the presenter in Full Body (entire body) or Upper Body (up to 60% of body) while tracking.
Effective Tracking Area	Set up a tracking area (optional). When Effective Tracking Area function is on, the camera only tracks around the selected area. Check the box to turn on the function and then click Set , a red frame appears in the preview window. Drag the upper-left or the lower-right corner of the red frame to adjust the tracking area. <div data-bbox="602 1155 908 1326" data-label="Image"> </div>
Auto Zoom	When Auto Zoom is off, the camera stops zooming in/out automatically but keep the zoom size based on the preset point selected from the drop-down list below.
Auto Tilt	Check the box to turn on the Auto Tilt function.



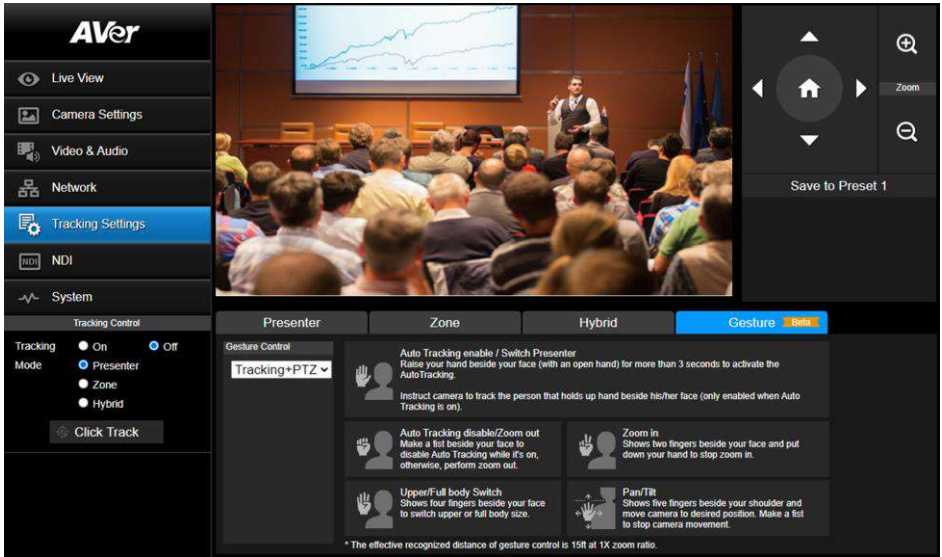

Gesture

The Gesture Control allows you to control certain camera functions with hand gestures. Connect your device to the screen with an HDMI cable.



To perform the gesture control function:

1. Turn off the **Tracking Mode** first.
2. Ensure the camera has been set up at 1X zoom ratio and the distance between the presenter and the camera is 15ft.
3. On the **Gesture Control** drop-down list, select an option to turn on the gesture control function.
 - **Off:** Select to turn off the gesture control function. When Auto Tracking is off, the camera will automatically return to the preset position you choose.
 - **Tracking:** Select to turn on the gesture control functions in the Tracking mode. Gesture functions include turning on or off Auto Tracking and switching people size between full and upper body.
 - **PTZ:** Select to turn on the gesture control functions in the PTZ mode. Gesture functions include zoom in/out and pan/tilt control.
 - **Tracking+PTZ:** Select to turn on the gesture control functions both in the Tracking and PTZ mode.
4. When the camera recognize the gestures, the LED indicator will blink purple and the system will activate the corresponding functions.

Gesture	Description
	<p>Auto Tracking enable / Switch Presenter</p> <p>Raise your hand beside your face (with an open hand) for more than 3 seconds to activate the Auto Tracking.</p> <p>Instruct camera to track the person that holds up beside his/her face (only enabled when Auto Tracking is on).</p>
	<p>Auto Tracking disable/ Zoom out</p> <p>Make a fist beside your face to disable Auto Tracking while it's on; otherwise perform zoom out.</p>
	<p>Upper/Full Body Switch</p> <p>Shows four fingers beside your face to switch upper or full body size.</p>
	<p>Zoom In</p> <p>Shows two fingers beside your face and put down your hand to stop zoom in.</p>
	<p>Pan/Tilt</p> <p>Shows five fingers beside your shoulder and move camera to desired position. Make a fist to stop camera movement.</p>

NDI

You can activate the NDI function using this page. Camera firmware version v31 and later supports NDI function.

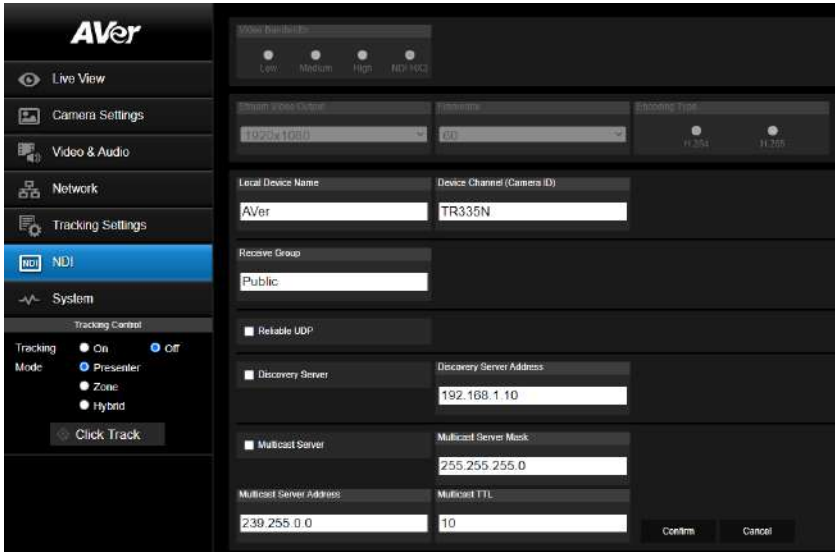

To set up the NDI function:

This camera is compatible with **NDI | HX3** of NewTek, Inc. To use **NDI | HX3**, you are required to purchase the license key from the URL of NewTek, Inc.

<https://www.newtek.com/ndihx/products/upgrade/>

To activate the NDI license key:

1. Ensure the camera has been connected to the Internet for **NDI License Activation**.
2. Check whether camera firmware version is v31 or later to support the NDI function.
3. On the camera Web page of **NDI**, click the **NDI Activate Function** to enter the license key. When finished, click **Activate**. A message pops up for camera reboot. Click **OK** to reboot the camera.

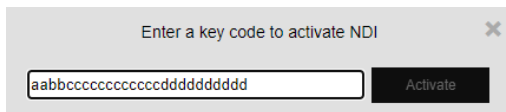

4. If success, go to **Video & Audio > Video Mode**, you will see **NDI** option on the drop-down list. Select **NDI** to turn on the **NDI** function. Please refer to **Video Mode** in [Video & Audio](#).

[Notes] When you turn on NDI, the camera don't support other video output source except HDMI/SDI.

Configure the below settings and then click **Confirm**.

Item	Description
Local Device Name	Enter a name of the camera to be shown within NDI devices. For best results, name all AVer cameras the same Local Device Name. e.g. PTZ Cameras or Tracking Cameras.
Device Channel (Camera ID)	Enter a channel name for the camera. The default camera name is TR335N. The supported characters are: <ul style="list-style-type: none">● Numeric characters: 0123456789● Alphabetic characters: ABCDEFGHIJKLMNOPQRSTUVWXYZ abcdefghijklmnopqrstuvwxyz● Symbols: ! @ % ^, . / : + ? [] { } - _ ~
Receive Group	Enter a name of the receive group. The Receive Group allows you to limit which users on your LAN can see the NDI source. The Receive Group is recommended to remain Public . Once the Receive Group is changed, you will need to join the Receive Group through NDI@ Access Manager.
Reliable UDP	Select the checkbox to turn on the UDP protocol.
Discovery Server	Select the checkbox to turn on Discovery Server . Enter the IP address in the Discovery Server Address column.
Multicast Server	Select the checkbox to turn on Multicast Server . Enter the related info in the Multicast Server Mask and Multicast Server Address columns. You can use the Multicast TTL to adjust the Multicast Time-To-Live interval.

System

You can view the system information, or configure some system settings on this page.

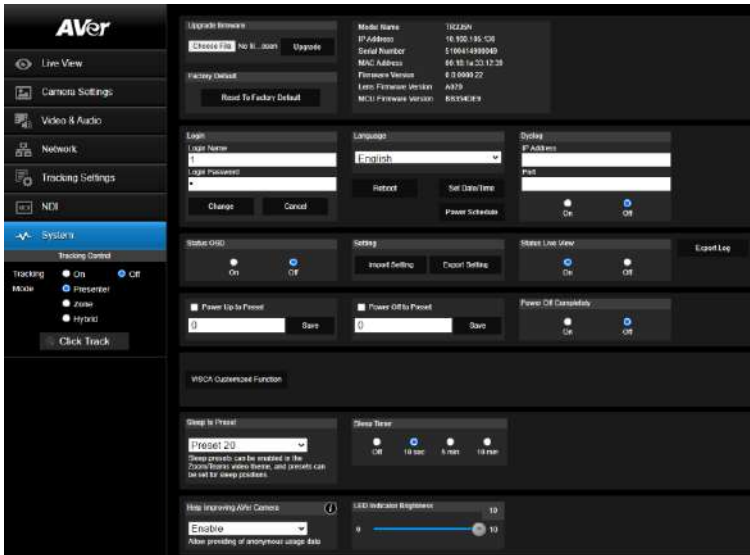

Item	Description
Upgrade firmware	To upgrade the firmware: <ol style="list-style-type: none"> 1. Download the newest firmware from https://www.aver.com/Download-Center/professional-ptz-camera 2. On the Web page, go to System > Upgrade firmware. 3. Click Choose File to select the firmware. 4. Click Upgrade to start upgrading the firmware. 5. Refresh the browser after the upgrade process is complete.
Factory Default	Click Reset To Factory Default to clear all values and reset the camera back to factory default settings.
Camera Information	Displays the camera information.
Login	The default Login Name and Login Password are 1/1. To change the login ID and password, enter the new Login Name and Login Password. When finished, click Change .
Language	Select a system language from the drop-down list. Click Reboot to reset the setting.
Set Date/Time	Click to turn on the Network Time Protocol and select a Time Zone from the drop-down list to automatically synchronize date and time. You can also turn off the NTP and enter date and time manually.

Power Schedule	Click to schedule time for powering on/off and Auto Reboot .
Syslog	Turn on Syslog to receive technical supports. Enter the IP Address and Port of the receiving device for debug and problem analysis.
Status OSD	Turn on or off status info on the live view, including operating the Preset (save preset, call preset and cancel preset), Zoom or Tracking functions.
Setting	Click Import Setting to import camera configurations. Click Export Setting to export camera configurations.
Status Live View	Click to turn on or off status live view.
Power Up to Preset	Select a pre-configured preset position from the drop-down list, the camera will move to the preset position when powered up.
Power Off to Preset	Select a pre-configured preset position from the drop-down list, the camera will move to the preset position when powered off.
Power Off Completely	<ul style="list-style-type: none"> ● On: The camera will enter Low Power mode when sleeping and will take more time to wake up and reboot. ● Off: To disable the setting above.
VISCA Customized Function	Configure the settings and then click OK .
Sleep to Preset	Select a pre-configured preset point for the camera to move to when enter the Sleep mode . To turn off Sleep mode , select Off from the drop-down list.
Sleep Timer	Set up a duration for the sleep timer. When there is no UVC connection and timer is up, the camera will enter the sleep mode. To perform this function, ensure to select ZOOM or Teams in the Video & Audio > Theme Mode setup field.
Help Improving AVer Camera	Select from the drop-down list to set if you allow the providing of anonymous usage data.
LED Indicator Brightness	Drag the slider to adjust the brightness value.

Appendix

VISCA RS-232 Command Table

Command Set	Command	Command Packet	Comments
CAM_Power	On	8x 01 04 00 02 FF	Power ON/OFF
	Off	8x 01 04 00 03 FF	
CAM_Zoom	Stop	8x 01 04 07 00 FF	
	Tele(Variable)	8x 01 04 07 2p FF	p=0 (Low) to 7 (High)
	Wide(Variable)	8x 01 04 07 3p FF	
	Direct	8x 01 04 47 0p 0q 0r 0s FF	pqrs: Zoom Position PTC310: 0x0000-0x6f20 PTC330: 0x0110-0x5490
CAM_Focus	Stop	8x 01 04 08 00 FF	
	Far (Standard)	8x 01 04 08 02 FF	Each 'Far/Near' needs a 'stop'
	Near (Standard)	8x 01 04 08 03 FF	
	Auto Focus	8x 01 04 38 02 FF	
	Manual Focus	8x 01 04 38 03 FF	
	One Push	8x 01 04 18 01 FF	
CAM_WB	Direct	8x 01 04 47 0p 0q 0r 0s FF	pqrs: Zoom Position
	Auto	8x 01 04 35 00 FF	Normal Auto
	ATW	8x 01 04 35 04 FF	
	Indoor	8x 01 04 35 01 FF	
	Outdoor	8x 01 04 35 02 FF	
	One Push WB	8x 01 04 35 03 FF	One Push WB mode
	Manual	8x 01 04 35 05 FF	Manual Control mode
	One Push	8x 01 04 10 05 FF	One Push WB Trigger
CAM_RGain	Up	8x 01 04 03 02 FF	Manual Control of R Gain
	Down	8x 01 04 03 03 FF	
CAM_Bgain	Up	8x 01 04 04 02 FF	Manual Control of B Gain
	Down	8x 01 04 04 03 FF	
CAM_AE	Full Auto	8x 01 04 39 00 FF	Automatic Exposure mode
	Manual	8x 01 04 39 03 FF	Manual Control mode
	Shutter Priority	8x 01 04 39 0A FF	Shutter Priority Automatic Exposure mode
	Iris Priority	8x 01 04 39 0B FF	Iris Priority Automatic Exposure mode
	Bright	8x 01 04 39 0D FF	Bright Mode (Manual control)
CAM_Shutter	Up	8x 01 04 0A 02 FF	Shutter Setting
	Down	8x 01 04 0A 03 FF	
CAM_Iris	Up	8x 01 04 0B 02 FF	Iris Setting
	Down	8x 01 04 0B 03 FF	
CAM_Gain	Up	8x 01 04 0C 02 FF	Gain Setting
	Down	8x 01 04 0C 03 FF	
CAM_Bright	Up	8x 01 04 0D 02 FF	Bright Setting
	Down	8x 01 04 0D 03 FF	
CAM_Exposure Compensation	Up	8x 01 04 0E 02 FF	Exposure Compensation Amount Setting
	Down	8x 01 04 0E 03 FF	
CAM_Backlight	On	8x 01 04 33 02 FF	Back Light Compensation ON/OFF
	Off	8x 01 04 33 03 FF	
CAM_Preset	Reset	8x 01 04 3F 00 pp FF	pp: Preset Number 0x00-0xFF

	Set	8x 01 04 3F 01 pp FF	
	Recall	8x 01 04 3F 02 pp FF	
CAM_Menu	On/Off	8x 01 06 06 10 FF	Display ON/OFF
Pan-tilt Drive	Up	8x 01 06 01 VV WW 03 01 FF	VV: Pan speed setting 0x01 (low speed) to 0x18 (high speed) WW: Tilt speed setting 0x01 (low speed) to 0x18 (high speed)
	Down	8x 01 06 01 VV WW 03 02 FF	
	Left	8x 01 06 01 VV WW 01 03 FF	
	Right	8x 01 06 01 VV WW 02 03 FF	
	UpLeft	8x 01 06 01 VV WW 01 01 FF	
	UpRight	8x 01 06 01 VV WW 02 01 FF	
	DownLeft	8x 01 06 01 VV WW 01 02 FF	
	DownRight	8x 01 06 01 VV WW 02 02 FF	
	Stop	8x 01 06 01 VV WW 03 03 FF	
	Home	8x 01 06 04 FF	
	Reset	8x 01 06 05 FF	
CAM_WDR	On	8x 01 04 3D 02 FF	Wdr ON/OFF
	Off	8x 01 04 3D 03 FF	
CAM_MenuEnter		8x 01 7E 01 02 00 01 FF	Enter Submenu
Tally Lamp	ON (RED)	8x 01 7E 01 0A 00 02 FF	
	OFF	8x 01 7E 01 0A 00 03 FF	
	ON (AMBER)	8x 01 7E 01 0A 00 04 FF	
	ON (GREEN)	8x 01 7E 01 0A 00 05 FF	
Freeze	Preset Freeze On	81 01 04 62 22 FF	Freeze On When Running Preset
	Preset Freeze Off	81 01 04 62 23 FF	Freeze Off When Running Preset
Auto Tracking	On	8x 01 04 7D 02 FF	Auto tracking ON/OFF
	Off	8x 01 04 7D 03 FF	
CAM_Memory Special	Set	8x 01 04 3F 01 pp FF	These are changeable depending on VISCA Customized Functions web setting: pp: 0x00 To 0xFF normal preset pp: 0x5F => Turn on OSD menu pp: 0xA0 => Full Body pp: 0xA1 => Upper Body pp: 0xA2 => Tracking Point pp: 0xA3 => Switch pp: 0xA4 => Presenter mode (supported in FW v25 or newer) pp: 0xA5 => Zone mode (supported in FW v25 or newer) pp: 0xA6 => Hybrid mode (supported in FW v35 or newer)
Absolute Position	Set	8x 01 06 02 VV WW 0Y 0Y 0Y 0Y 0Z 0Z 0Z 0Z FF	VV: Pan speed setting 0x01 (low speed) to 0x18 (high speed) WW: Tilt speed setting 0x01 (low speed) to 0x18 (high speed) YYYY: Pan Position ZZZZ: Tilt Position
Auto zoom	On	8x 01 04 A0 02 FF	
	Off	8x 01 04 A0 03 FF	
Effective Tracking area	On	8x 01 04 A1 02 FF	
	Off	8x 01 04 A1 03 FF	
RTMP	On	8x 01 04 A2 02 FF	
	Off	8x 01 04 A2 03 FF	
Reboot	On	8x 01 04 A4 FF	
	On	8x 01 04 A5 02 FF	

Preset Affects PTZ & Focus Values Only	Off	8x 01 04 A5 03 FF	
Relative Zoom Ratio	On	8x 01 04 A6 02 FF	
	Off	8x 01 04 A6 03 FF	
Auto Tilt	On	8x 01 04 A7 02 FF	
	Off	8x 01 04 A7 03 FF	
Auto Zoom/Tilt preset	Set	8x 01 04 A8 pp FF	pp: 0x00 To 0xFF normal preset

Inquiry Command	Command Packet	Reply Packet	Comments
CAM_PowerInq	8x 09 04 00 FF	y0 50 02 FF	On
		y0 50 03 FF	Off
CAM_WBModelInq	8x 09 04 35 FF	y0 50 00 FF	Auto
		y0 50 01 FF	In Door
		y0 50 02 FF	Out Door
		y0 50 03 FF	One Push WB
		y0 50 04 FF	ATW
		y0 50 05 FF	Manual
CAM_RGainInq	8x 09 04 43 FF	y0 50 00 00 0p 0q FF	pq: R Gain
CAM_BGainInq	8x 09 04 44 FF	y0 50 00 00 0p 0q FF	pq: B Gain
CAM_AEModelInq	8x 09 04 39 FF	y0 50 00 FF	Full Auto
		y0 50 03 FF	Manual
		y0 50 0A FF	Shutter Priority
		y0 50 0B FF	Iris Priority
		y0 50 0D FF	Bright
CAM_ShutterPosInq	8x 09 04 4A FF	y0 50 00 00 0p 0q FF	pq: Shutter Position
CAM_IrisPosInq	8x 09 04 4B FF	y0 50 00 00 0p 0q FF	pq: Iris Position
CAM_GainPosInq	8x 09 04 4C FF	y0 50 00 00 0p 0q FF	pq: Gain Position
CAM_BrightPosInq	8x 09 04 4D FF	y0 50 00 00 0p 0q FF	pq: Bright Position
CAM_ExpCompPosInq	8x 09 04 4E FF	y0 50 00 00 0p 0q FF	pq: ExpComp Position
CAM_FocusModelInq	8x 09 04 38 FF	y0 50 02 FF	Auto Focus
		y0 50 03 FF	Manual Focus
CAM_FocusPosInq	8x 09 04 48 FF	y0 50 0p 0q 0r 0s FF	pqrs: Focus Position
zoom_Pos_Inq	8x 09 04 47 FF	y0 50 0p 0q 0r 0s FF	pqrs: Zoom Position
PT_Pos_Inq	8x 09 06 12 FF	y0 50 0Y 0Y 0Y 0Y 0Z 0Z 0Z FF	YYYY: Pan Position 8A14 to 762C (CENTER 0000) ZZZZ: Tilt Position 468B to E898 (Image Flip: OFF) (CENTER 0000)
CAM_Preset Inq	8x 09 04 3F FF	y0 50 pp FF	Return the last preset number which has been operated pp:01-FF
CAM_Tracking status	8x 09 36 69 02 FF	y0 50 01 FF	On
		y0 50 00 FF	Off
CAM_Tracking_mode	8x 09 36 69 01 FF	y0 50 01 FF	Presenter
		y0 50 02 FF	Zone
		y0 50 03 FF	Hybrid
CAM_Tracking body size	8x 09 36 69 03 FF	y0 50 01 FF	Full body
		y0 50 02 FF	Upper body
CAM_OSD MENU on/off	8x 09 7E 04 76 01 FF	y0 50 02 FF	On
		y0 50 03 FF	Off
CAM_Tally	8x 09 7E 01 0A FF	y0 50 02 FF	On
		y0 50 03 FF	Off
CAM_WDR mode	8x 09 04 3D FF	y0 50 02 FF	On

		y0 50 03 FF	Off
CAM_BLC mode	8x 09 04 33 FF	y0 50 02 FF	On
		y0 50 03 FF	Off
CAM_Live Freeze	8x 09 04 62 01 FF	y0 50 02 FF	Freeze On
		y0 50 03 FF	Freeze Off
CAM_Preset Freeze	8x 09 04 62 02 FF	y0 50 02 FF	Preset Freeze On
		y0 50 03 FF	Preset Freeze Off
Firmware version	8x 09 36 69 04 FF	y0 50 0p 0q 0r 0s 0t 0u 0v 0w FF	fw_ver: p.q.rstu.vw
USB Status	8x 09 36 69 05 FF	y0 50 00 FF	USB cable plug out
		y0 50 01 FF	USB cable plug in
UVC Status	8x 09 36 69 06 FF	y0 50 00 FF	UVC stream off
		y0 50 01 FF	UVC stream on

Visca over IP Settings

VISCA over IP

PORT

Internet protocol	IPv4
Transport protocol	UDP
Port address	52383

FORMAT

	byte 0	byte 1	byte 2	byte 3	byte 4	byte 5	byte 6	byte 7	byte 8 — byte 23	
func	Payload type		Payload length		Sequence number			Payload (1 to 15 bytes)		
data	Value1	Value2	1~7a (000001~000010)		000000000~00FFFFFFF			VISCA Packet (see page VISCA)		

Payload type

Name	Value1	Value2	Description
VISCA command	0x01	0x00	Stores the VISCA command.
VISCA inquiry	0x01	0x10	Stores the VISCA inquiry.
VISCA reply	0x01	0x11	Stores the reply for the VISCA command or VISCA inquiry.

Sequence number

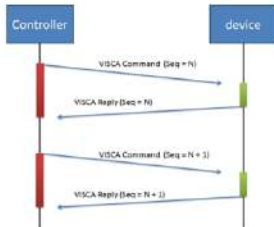

Sequence number = N

CGI Command

CGI List for Video Transmission					
CGI Item name	URL	Command	Parameter Name	Parameter value	Description
Get JPEG	/snapshot				1280x720.jpg
Get RTSP stream	rtsp://ip/live_st1				
CGI List for Camera Control					
CGI Item name	URL	Command	Parameter Name	Parameter value	Description
up start	/cgi-bin?SetPtzf=	1,0,1&(random)			
up end	/cgi-bin?SetPtzf=	1,0,2&(random)			
down start	/cgi-bin?SetPtzf=	1,1,1&(random)			
down end	/cgi-bin?SetPtzf=	1,1,2&(random)			
left start	/cgi-bin?SetPtzf=	0,1,1&(random)			
left end	/cgi-bin?SetPtzf=	0,1,2&(random)			
right start	/cgi-bin?SetPtzf=	0,0,1&(random)			
right end	/cgi-bin?SetPtzf=	0,0,2&(random)			
zoom_in start	/cgi-bin?SetPtzf=	2,0,1&(random)			
zoom_in end	/cgi-bin?SetPtzf=	2,0,2&(random)			
zoom_out start	/cgi-bin?SetPtzf=	2,1,1&(random)			
zoom_out end	/cgi-bin?SetPtzf=	2,1,2&(random)			
set preset:	/cgi-bin?ActPreset=	1,N&(random)			N : position
load preset:	/cgi-bin?ActPreset=	0,N&(random)			N : position
set preset speed	/cgi-bin?Set=preset_speed,3,val	val: {min: 1, max: 6}			
Absolute Position (Pan)	/cgi-bin?Set=ptz_p,3,val	val: {min: 2048, mid: 962944, max: 1925888}			Follows CGI preset speed
Absolute Position (Tilt)	/cgi-bin?Set=ptz_t,3,val	val: {min: 2048, mid: 165696, max: 662784}			Follows CGI preset speed
Absolute Position (Zoom)	/cgi-bin?Set=ptz_z,3,val	val: {min: 2048, mid: 14224, max: 28448}			Follows CGI preset speed
CGI List for Various Settings					
exposure value	/cgi-bin?Set=	img_expo_expo,3,N&(random)	value	1 - 9	N : value
saturation	/cgi-bin?Set=	img_saturation,3,N&(random)	value	0 - 10	N : value
contrast	/cgi-bin?Set=	img_contrast,3,N&(random)	value	0 - 4	N : value
Tracking on:	/cgi-bin?Set=	trk_tracking_on,3,1			
Tracking off:	/cgi-bin?Set=	trk_tracking_on,3,0			
Reboot	GET(Basic Authentication)	/cgi-bin?OnePush=!			
Factory Reset	GET(Basic Authentication)	/cgi-bin?OnePush=d			
Mode Presenter		/cgi-bin?Set=trk_mode,3,1&X	value	random number	X : value
Mode Zone		/cgi-bin?Set=trk_mode,3,2&X	value	random number	X : value

Mode Hybrid		/cgi-bin?Set=trk_mode,3,3&X			
Mode Get	GET(Basic Authentication)	/cgi-bin?Get=trk_mode,3&_=X	- Reply	Presenter trk_mode,3=1 Zone trk_mode,3=2 Hybrid trk_mode,3=3	X : value
Click Track ON	GET(Basic Authentication)	/cgi-bin?Set=trk_update_detect,3,1			
Click Track OFF	GET(Basic Authentication)	/cgi-bin?Set=trk_update_detect,3,0			
Click Track Get detect zone (Humanoid outlines) number	GET(Basic Authentication)	/cgi-bin?Get=trk_detect_num,3			Need to be sent along with Click Track ON command
	- Reply	"trk_detect_num,3=X\r\n"	X: The amount of humanoid outlines, maximum: 50		
Click Track Get detect zone (Humanoid outlines) info	GET(Basic Authentication)	/cgi-bin?GetTrackingDetectZone=X	X: The amount of humanoid outlines, maximum: 50		
	- Reply	"focus:-1\nzone[00]:00,119,720,960\nzone[01]:-1502615204,-1366225632,01,-1366223544"	focus - The number of humanoid outline being tracked. zone[NN]:x,y,w,h - based on 1080P resolution	The upper left corner of the screen is the coordinate reference (0,0), x-coordinate/y-coordinate/w width/h height, based on the upper left corner of the humanoid outline. The number following indicates the number of the tracked person, for example, -1 means that no one is being tracked. If one of the three is being tracked, one of 0, 1 and 2 will appear after the 'focus'.	
Click Track Set target zone	GET(Basic Authentication)	/cgi-bin?Set=trk_assign_zone,3,X	X: The number of the humanoid outlines		
	- Reply	http response: ok			
	GET(Basic Authentication)	/cgi-bin?SetString=TrackingFocusZone,[x,y,w,h]			
- Reply	http response: ok				
Tracking On/Off Get	GET(Basic Authentication)	/cgi-bin?Get=trk_tracking_on,3&_X	- Reply	On trk_tracking_on,3=1 Off trk_tracking_on,3=0"	X : value
RTMP Start streaming	/cgi-bin?Set=	vdo_rtmp_enable,3,1			
RTMP Stop streaming	/cgi-bin?Set=	vdo_rtmp_enable,3,0			
USB status	GET(Basic Authentication)	/cgi-bin?Get=usb_status_inquire,3			
	- Reply	"usb_status_inquire,3=X\r\n"	X: 0(plug out), 1(plug in)		

UVC status	GET(Basic Authentication)	/cgi-bin?Get=uvc_status_inquire,3			
	- Reply	"uvc_status_inquire,3=X\r\n"	X: 0(stream off), 1(stream on)		
Status get (Modle name & mac & FW_VER)		/cgi-bin?GetString=sys_name&net_mac&sys_fw_version&_ =1635216271678		http://10.100.105.110/cgi-bin?GetString=sys_name&net_mac&sys_fw_version&_ =1635216271678	
Serial No. get		/cgi-bin?GetSerialNumber&_ =1635216271680		http://10.100.105.110/cgi-bin?GetSerialNumber&_ =1635216271680	
script (Using cURL to update firmware)	curl.exe -X POST --user NAME:PASSWORD -F file1=@./ISP_FILE "http://IP_ADDRESS/system/"			<p>Please download curl (curl for Windows), this is a command line tool for network transferring.</p> <p>Put curl.exe and ISP file in the same folder. and then execute the script to upgrade camera.</p> <p>For example, ISP file is 0.0.0000.29.dat , IP address is 10.100.105.109 and username:password is 1:1 , you can enter this script to execute ISP process.</p> <p>curl.exe -X POST --user 1:1 -F file1=@./0.0.0000.29.dat "http://10.100.105.109/system/"</p>	

Pelco P Command

PTC300V2 Pelco-P command

PAN AND TILT COMMANDS		P/T bit(byte4.0) = 0						
	byte 1	byte 2	byte 3	byte 4	byte 5	byte 6	byte 7	byte 8
func	STX	ADDR	data1	data2	data3	data4	ETX	checksum
data	0xA0	0~7F	cmd 1	cmd 2	Pan speed	Tilt speed	0xAF	1~7 XOR

note : speed = 0x00~0x30

byte3 : command 1

bit 7	bit 6	bit 5	bit 4	bit 3	bit 2	bit 1	bit 0
NA	CAM ON	NA	CAM ON/OFF	NA	NA	NA	NA

note : power off : byte3.6 = 0 & byte3.4 = 1

byte4: command 2

bit 7	bit 6	bit 5	bit 4	bit 3	bit 2	bit 1	bit 0
NA	ZOOM Wide	ZOOM Tele	TILT Down	TILT Up	PAN Left	PAN Right	P/T bit 0(always)

EXTENDED COMMAND SET

		P/T bit(byte4.0) = 1						
	byte 1	byte 2	byte 3	byte 4	byte 5	byte 6	byte 7	byte 8
func	STX	ADDR	data1	data2	data3	data4	ETX	checksum
Set Preset XX		0xA0	0~7	0x00	0x03	0x00	Preset #	0xAF 1~7 XOR
Go To Preset XX		0xA0	0~7	0x00	0x07	0x00	Preset #	0xAF 1~7 XOR
Track ON		0xA0	0~7	0x00	0x55	0x00	0xAF	1~7 XOR
Track OFF		0xA0	0~7	0x00	0x67	0x00	0xAF	1~7 XOR

note : Preset # : 0x01 ~ 0xFF
Profile # : 0x01 ~ 0x05

Pelco D Command

pelco d command

PAN AND TILT COMMANDS

*/7 bit(byte4)=0

	byte 1	byte 2	byte 3	byte 4	byte 5	byte 6	byte 7
Func	SYNC	ADDR	cmd 1	cmd 2	data1	data2	checksum
data	0xFF	1*80	cmd 1	cmd 2	pan speed	tilt speed	2*8 SUM

note : speed = 0x07-0x30

byte3 : command 1

bit 7	bit 6	bit 5	bit 4	bit 3	bit 2	bit 1	bit 0
REVERSE	ON	NA	NA	NA	CAM	NA	NA
DIR	ON	OFF	OFF	OFF	NA	NA	NA

note : power off : byte3.7 = 0 & byte3.3 = 1

byte4 : command 2

bit 7	bit 6	bit 5	bit 4	bit 3	bit 2	bit 1	bit 0
ZOOM	ZOOM	ZOOM	TILT	TILT	PAH	PAH	*/7 bit
NA	Wide	Narrow	Down	Up	Left	Right	0x0a-0x0c

EXTENDED COMMAND SET

*/7 bit(byte4)=1

	byte 1	byte 2	byte 3	byte 4	byte 5	byte 6	byte 7
Func	SYNC	ADDR	data1	data2	data3	data4	checksum
Set Preset XX	0xFF	1*8	0x00	0x01	0x00	Preset #	2*8 SUM
Go To Preset XX	0xFF	1*8	0x00	0x07	0x00	Preset #	2*8 SUM
Track ON	0xFF	1*8	0x00	0x05	0x00	0x00	2*8 SUM
Track OFF	0xFF	1*8	0x00	0x07	0x00	0x00	2*8 SUM

note : Preset # = 0x01 ~ 0xFF

Example:

Camera Address: 1

Pan Left at high speed: FF 01 00 04 3F 00 44

Pan Right at medium speed: FF 01 00 02 20 00 23

Tilt Up at high speed: FF 01 00 08 00 3F 48

Tilt Down at medium speed: FF 01 00 18 20 00 31

Stop all actions (Pan / Tilt / Zoom / etc.): FF 01 00 00 00 00 01