

**datavideo**

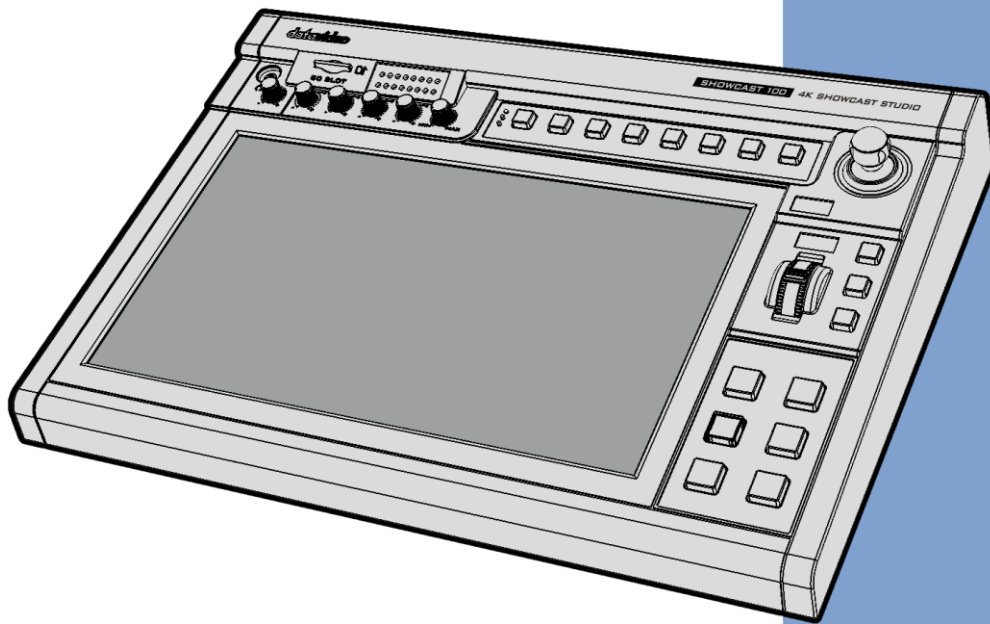

4K ShowCast STUDIO  
**SHOWCAST 100**  
**Instruction Manual**

[www.datavideo.com](http://www.datavideo.com)

# Table of Contents

<b>FCC COMPLIANCE STATEMENT</b> .....	<b>6</b>
<b>WARNINGS AND PRECAUTIONS</b> .....	<b>6</b>
<b>WARRANTY</b> .....	<b>7</b>
<i>STANDARD WARRANTY</i> .....	7
<i>THREE YEAR WARRANTY</i> .....	7
<b>DISPOSAL</b> .....	<b>8</b>
<b>CHAPTER 1 INTRODUCTION</b> .....	<b>9</b>
1.1 FEATURES .....	9
1.2 SYSTEM DIAGRAM .....	11
<b>CHAPTER 2 CONNECTIONS AND CONTROLS</b> .....	<b>13</b>
2.1 REAR PANEL .....	13
2.2 SWITCHER KEYBOARD PANEL .....	16
2.3 TOUCH SCREEN INTERFACE .....	22
<i>Multi Image Preview (Multiview)</i> .....	23
<i>Program Image (On Air)</i> .....	23
<i>Preview/Program Rows</i> .....	24
<i>Switcher Functions</i> .....	24
Switcher (Camera Presets).....	24
Setup (Camera Setup).....	25
Menu (OSD Menu).....	26
<b>CHAPTER 3 OSD MENU</b> .....	<b>27</b>
3.1 START .....	27
<i>Transition Type</i> .....	27
<i>Transition Speed</i> .....	27
<i>Wipe Effect</i> .....	28
<i>WIPE Border Size</i> .....	28
<i>WIPE Border Color</i> .....	28
<i>BKG Color</i> .....	28
<i>WIPE Rev.</i> .....	28
3.2 PIP / SPLIT.....	28
<i>PIP Source</i> .....	29
<i>PIP Size (PIP Window Size)</i> .....	29
<i>Position X</i> .....	30
<i>Position Y</i> .....	30
<i>Split Source</i> .....	30
<i>Border Size</i> .....	30
<i>Border Color</i> .....	30
<i>PIP/Split Mode</i> .....	30
<i>PGM</i> .....	30
<i>PVW</i> .....	30
3.3 PIP CROP .....	31
3.4 LUMAKEY.....	31
<i>Lumakey Source</i> .....	31

Mode.....	32
Cleanup Level.....	32
Transparency .....	32
PGM .....	32
PVW .....	32
3.5 AUDIO.....	32
Mute .....	32
HDMI Input .....	32
HDMI Group.....	32
Level.....	32
Tally Mode .....	33
Audio Delay.....	33
3.6 USER MEMS.....	33
Load Memory.....	33
Save Memory.....	33
3.7 SETUP .....	33
PGM Out Res.....	34
Stream Out Res .....	35
MV Mode .....	35
BLK Button Position .....	36
9:16 Safety Marker .....	36
Output Format .....	36
Save Setup.....	37
Factory Default .....	37
Language .....	37
Firmware Version.....	37
Firmware Upgrade.....	37
3.8 CAMERA .....	37
Scan.....	38
Camera.....	38
Tally Mapping .....	38
Camera Control.....	39
Baud Rate .....	39
IP .....	39
Camera Info .....	39
Model.....	39
Video Format .....	39
Mirror Mode .....	39
Joystick Pan.....	39
Joystick Tilt.....	39
R-Gain .....	40
B-Gain .....	40
Tally LED.....	40
Menu.....	40
Enter.....	40
3.9 NETWORK.....	40
Address Mode .....	40
IP Address .....	40
Network Mask.....	40

Gateway.....	40
Primary DNS.....	40
Secondary DNS.....	41
MAC Address.....	41
Network Def.....	41
IP Save.....	41
<b>CHAPTER 4 DVIP.....</b>	<b>42</b>
4.1 SETUP .....	42
4.2 FEATURES .....	42
Device Search.....	44
Device Clear .....	44
Switch to Other Network Interfaces .....	44
Language Selection.....	44
About .....	44
4.3 EXAMPLE SETUP .....	45
<b>CHAPTER 5 APPLICATIONS.....</b>	<b>48</b>
5.1 PLACING A LOGO ON THE VIDEO USING THE LUMAKEY.....	48
<b>CHAPTER 6 VIDEO STREAMING AND RECORDING.....</b>	<b>49</b>
6.1 NETWORK CONNECTION AND DEVICE SEARCH.....	49
Default Fixed IP.....	49
Connecting to a DHCP Network (DHCP Mode) .....	52
Connecting to a NON-DHCP Network (Static IP) .....	53
Troubleshooting the Network Connection.....	54
Advanced Troubleshooting.....	55
6.2 WEB USER INTERFACE .....	55
Source .....	56
Operation Mode .....	56
Stream Mode .....	57
Record Mode .....	61
CG.....	65
Text .....	65
News .....	68
Graphic.....	69
Logo.....	69
Animation .....	70
Monitor.....	72
System.....	72
Network Setting.....	74
Account and Password.....	74
Time Setting .....	74
Firmware Update .....	75
Disk Format.....	75
Device Name Setting.....	75
Other Option.....	75
System Control.....	76
Status .....	76
Vertical.....	76
6.3 OPERATIONS.....	77

<i>Video Streaming</i> .....	77
RTSP/TS/HLS .....	77
RTMP .....	81
SRT .....	83
6.4 RECORD/STREAM PANEL .....	84
<i>Record Button</i> .....	84
<i>Stream Button</i> .....	85
<i>Bitrate Button</i> .....	85
<i>Vertical Button</i> .....	85
6.5 RESTORING FACTORY DEFAULTS .....	85
6.6 FIRMWARE UPDATE .....	86
<b>CHAPTER 7 APPENDICES .....</b>	<b>87</b>
APPENDIX 1 TALLY OUTPUTS .....	87
APPENDIX 2 RS-232/RS-422 PINOUTS .....	88
RS-232 .....	88
RS-422 .....	88
APPENDIX 3 FIRMWARE UPGRADE .....	89
<i>Keyboard / Mainboard</i> .....	89
<i>Video Streaming Server</i> .....	89
APPENDIX 4 RECOMMENDED SD CARDS .....	91
APPENDIX 5 FREQUENTLY-ASKED QUESTIONS .....	93
APPENDIX 6 DIMENSIONS .....	94
APPENDIX 7 SPECIFICATIONS .....	95
<b>SERVICE AND SUPPORT .....</b>	<b>100</b>

### **Disclaimer of Product & Services**

The information offered in this instruction manual is intended as a guide only. At all times, Datavideo Technologies will try to give correct, complete and suitable information. However, Datavideo Technologies cannot exclude that some information in this manual, from time to time, may not be correct or may be incomplete. This manual may contain typing errors, omissions or incorrect information. Datavideo Technologies always recommend that you double check the information in this document for accuracy before making any purchase decision or using the product. Datavideo Technologies is not responsible for any omissions or errors, or for any subsequent loss or damage caused by using the information contained within this manual. Further advice on the content of this manual or on the product can be obtained by contacting your local Datavideo Office or dealer.

## FCC Compliance Statement

This device complies with part 15 of the FCC rules. Operation is subject to the following two conditions:

- (1) This device may not cause harmful interference, and
- (2) This device must accept any interference received, including interference that may cause undesired operation.

## Warnings and Precautions

1. Read all of these warnings and save them for later reference.
2. Follow all warnings and instructions marked on this unit.
3. Unplug this unit from the wall outlet before cleaning. Do not use liquid or aerosol cleaners. Use a damp cloth for cleaning.
4. Do not use this unit in or near water.
5. Do not place this unit on an unstable cart, stand, or table. The unit may fall, causing serious damage.
6. Slots and openings on the cabinet top, back, and bottom are provided for ventilation. To ensure safe and reliable operation of this unit, and to protect it from overheating, do not block or cover these openings. Do not place this unit on a bed, sofa, rug, or similar surface, as the ventilation openings on the bottom of the cabinet will be blocked. This unit should never be placed near or over a heat register or radiator. This unit should not be placed in a built-in installation unless proper ventilation is provided.
7. This product should only be operated from the type of power source indicated on the marking label of the AC adapter. If you are not sure of the type of power available, consult your Datavideo dealer or your local power company.
8. Do not allow anything to rest on the power cord. Do not locate this unit where the power cord will be walked on, rolled over, or otherwise stressed.
9. If an extension cord must be used with this unit, make sure that the total of the ampere ratings on the products plugged into the extension cord do not exceed the extension cord rating.
10. Make sure that the total amperes of all the units that are plugged into a single wall outlet do not exceed 15 amperes.
11. Never push objects of any kind into this unit through the cabinet ventilation slots, as they may touch dangerous voltage points or short out parts that could result in risk of fire or electric shock. Never spill liquid of any kind onto or into this unit.
12. Except as specifically explained elsewhere in this manual, do not attempt to service this product yourself. Opening or removing covers that are marked "Do Not Remove" may expose you to dangerous voltage points or other risks, and will void your warranty. Refer all service issues to qualified service personnel.



13. Unplug this product from the wall outlet and refer to qualified service personnel under the following conditions:
- a. When the power cord is damaged or frayed;
  - b. When liquid has spilled into the unit;
  - c. When the product has been exposed to rain or water;
  - d. When the product does not operate normally under normal operating conditions. Adjust only those controls that are covered by the operating instructions in this manual; improper adjustment of other controls may result in damage to the unit and may often require extensive work by a qualified technician to restore the unit to normal operation;
  - e. When the product has been dropped or the cabinet has been damaged;
  - f. When the product exhibits a distinct change in performance, indicating a need for service.

## Warranty

### ***Standard Warranty***

- Datavideo equipment are guaranteed against any manufacturing defects for one year from the date of purchase.
- The original purchase invoice or other documentary evidence should be supplied at the time of any request for repair under warranty.
- The product warranty period begins on the purchase date. If the purchase date is unknown, the product warranty period begins on the thirtieth day after shipment from a Datavideo office.
- All non-Datavideo manufactured products (product without Datavideo logo) have only one year warranty from the date of purchase.
- Damage caused by accident, misuse, unauthorized repairs, sand, grit or water is not covered under warranty.
- Viruses and malware infections on the computer systems are not covered under warranty.
- Any errors that are caused by unauthorized third-party software installations, which are not required by our computer systems, are not covered under warranty.
- All mail or transportation costs including insurance are at the expense of the owner.
- All other claims of any nature are not covered.
- All accessories including headphones, cables, and batteries are not covered under warranty.
- Warranty only valid in the country or region of purchase.
- Your statutory rights are not affected.

### ***Three Year Warranty***

- All Datavideo products purchased after July 1st, 2017 are qualified for a free two years extension to the standard warranty, providing the product is registered with Datavideo within 30 days of purchase.



- Certain parts with limited lifetime expectancy such as LCD panels, DVD drives, Hard Drive, Solid State Drive, SD Card, USB Thumb Drive, Lighting, Camera module, PCIe Card are covered for 1 year.
- The three-year warranty must be registered on Datavideo's official website or with your local Datavideo office or one of its authorized distributors within 30 days of purchase.

## Disposal

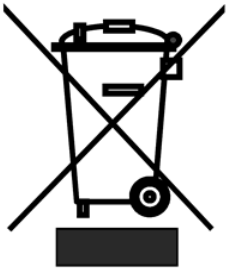

### **For EU Customers only - WEEE Marking**

This symbol on the product or on its packaging indicates that this product must not be disposed of with your other household waste. Instead, it is your responsibility to dispose of your waste equipment by handing it over to a designated collection point for the recycling of waste electrical and electronic equipment. The separate collection and recycling of your waste equipment at the time of disposal will help to conserve natural resources and ensure that it is

recycled in a manner that protects human health and the environment. For more information about where you can drop off your waste equipment for recycling, please contact your local city office, your household waste disposal service or the shop where you purchased the product.



**CE Marking** is the symbol as shown on the left of this page. The letters "CE" are the abbreviation of French phrase "Conformité Européene" which literally means "European Conformity". The term initially used was "EC Mark" and it was officially replaced by "CE Marking" in the Directive 93/68/EEC in 1993. "CE

Marking" is now used in all EU official documents.



# Chapter 1 Introduction

The SHOWCAST 100 is an all in one switcher featuring Video Switching, Streaming, Recording, Camera Control and Audio Mixing in one box. It is a UHD 4K 4-input switcher with an integrated 14-inch touch panel.

The built-in network streaming function allows you to stream videos to all major streaming platforms live. Moreover, the video stream can be recorded to the SD card for backup purpose.

The SHOWCAST 100 offers remote control of multiple cameras settings such as pan, tilt, zoom, iris, focus, gain and white balance. It connects up to 3 Datavideo cameras over a long distance via Ethernet cables.

The switcher is equipped with luma key for graphic overlays, split screen for podcast interviews, and PiP for PowerPoint presentations. It is also equipped with a built-in audio mixer allowing users to directly connect microphones and other audio sources.



## 1.1 Features

### Major Functions

- Support up to Ultra HD 4K/60 video formats.
- Large 14" LCD touch screen for switcher operation and video monitoring.
- Offers remote control of multiple camera settings such as pan, tilt, zoom, iris, focus, shutter, and white balance.
- The built-in H.264 encoder delivers your live video to any major live streaming platforms.

- Live streaming of vertically or horizontally oriented videos.
- A built-in H.264 recorder for video backup on SD cards.

### **Other Functions**

- Auto up/down scaling of the input resolution
- 4 HDMI 2.0 video inputs + 4 HDMI 2.0 video outputs
- Audio inputs (1 x stereo RCA, 2 x LINE Input)
- Audio outputs (1 x stereo RCA, 1 x stereo headphone mini jack)
- Four-channel audio mixer and embedded audio source
- Wipe, Mix & Simple Cut Transitions
- Lumakey for title overlay
- Picture-in-picture and split views
- RS-422, RS-232 and DVIP control
- Tally output

# 1.2 System Diagram

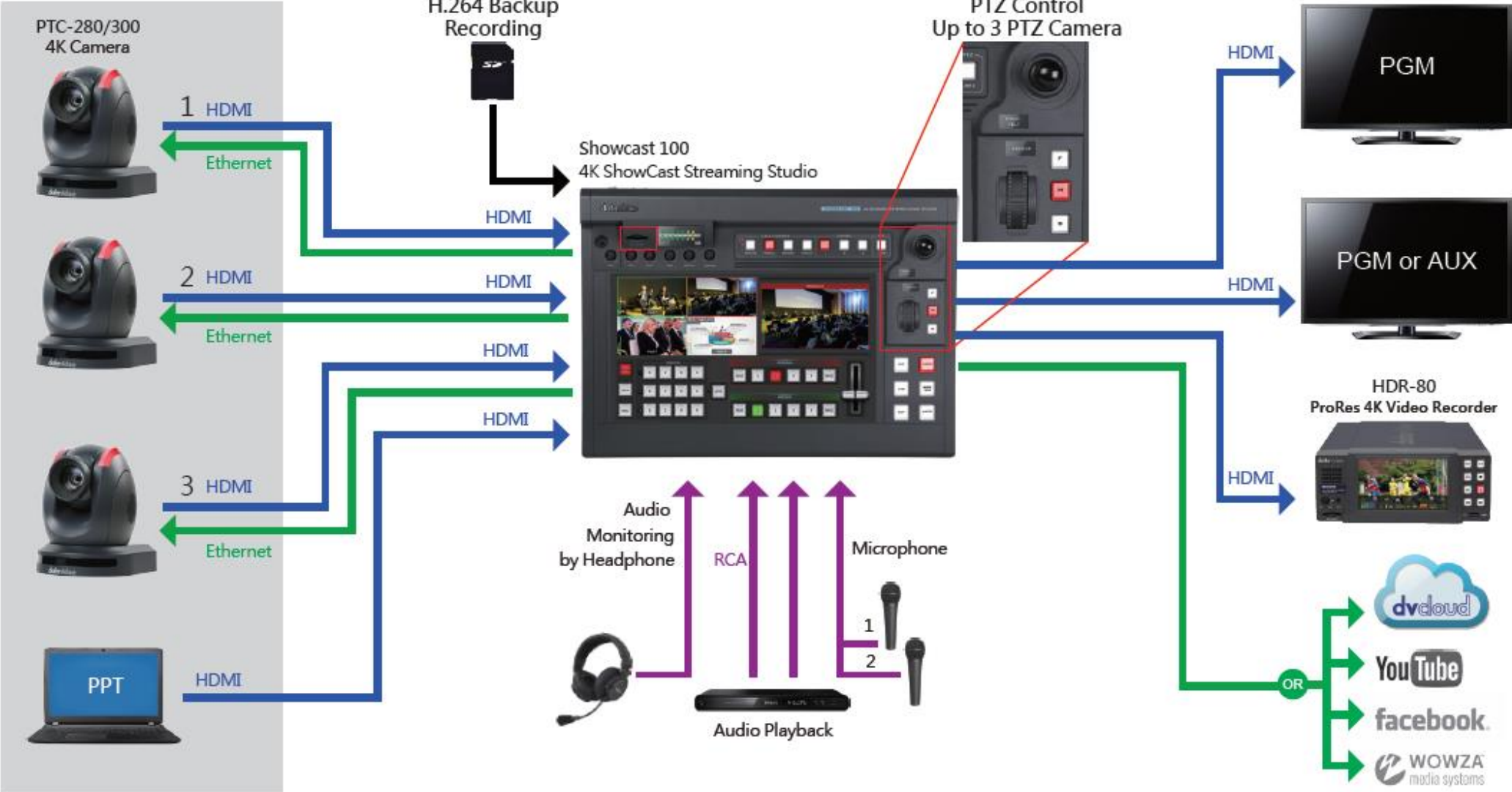

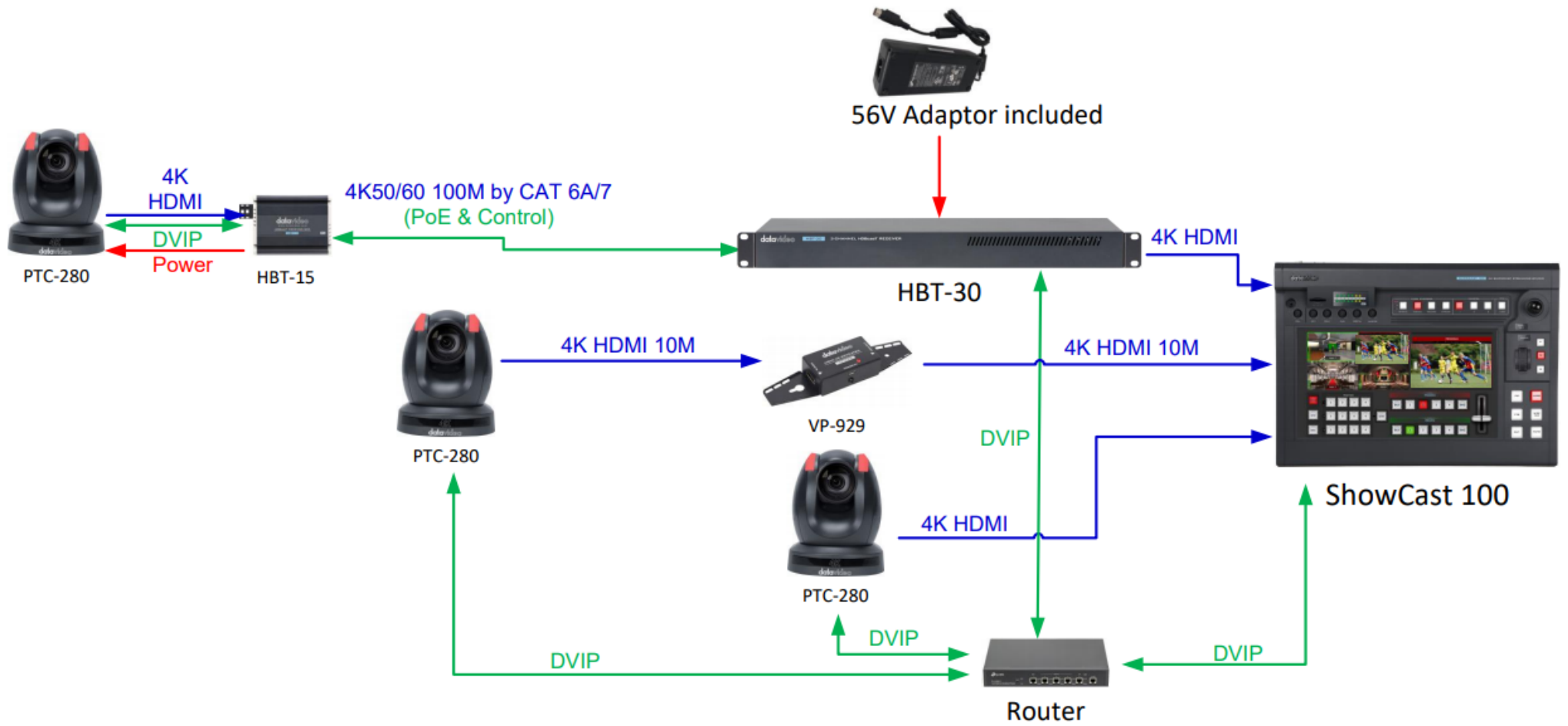

# Chapter 2 Connections and Controls

## 2.1 Rear Panel

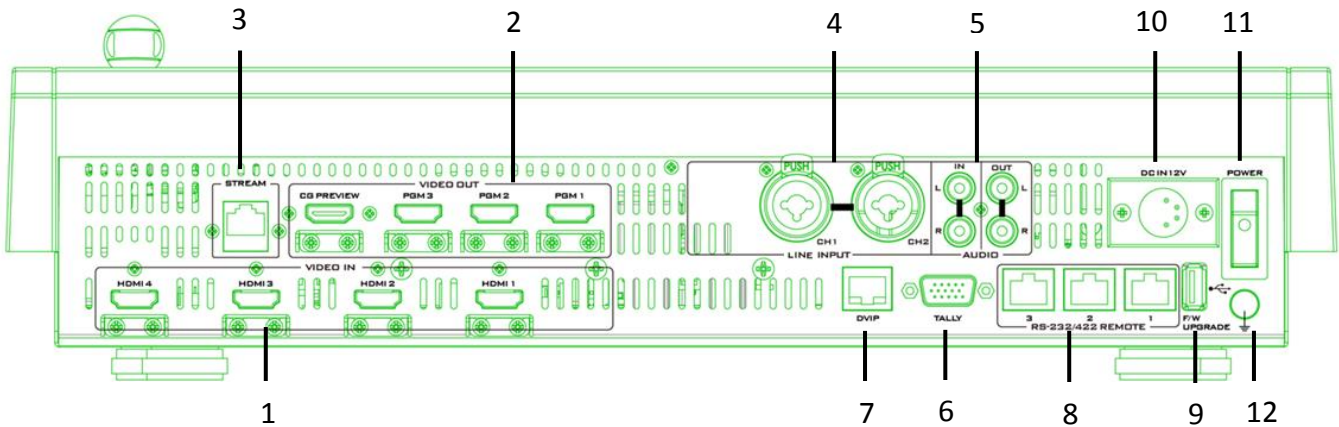

1	HDMI Video IN x 4	7	DVIP
2	HDMI Video OUT x 4 (3 PGM + 1 CG Preview)	8	RS-232/422 Remote x 3
3	Stream OUT	9	F/W Upgrade Port
4	LINE Input CH1/CH2	10	DC IN
5	Stereo RCA AUDIO IN/OUT	11	Power Switch
6	TALLY Output Port	12	Ground



### 1. HDMI Video IN

The **HDMI** Input ports allow connection of HDMI video sources with the images displayed in the respective four quadrants of the Multiview shown below. The Multiview is displayed on the touch screen interface. See [Section 2.3](#) for details.

### Multiview

HDMI 1 (CH1)	HDMI 2 (CH2)
HDMI 3 (CH3)	HDMI 4 (CH4)

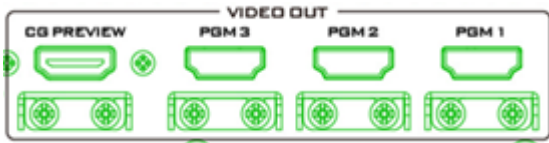

## 2. HDMI Video OUT ports

The HDMI Video Out ports 1 – 3 output Program video only. Connect these ports to any HDMI monitors or other HDMI destination devices.

The CG Preview output port allows you to preview the CG text or image on the monitor connected. See [CG](#) in [Section 6.2](#) for more information about setting up your CG text or image.

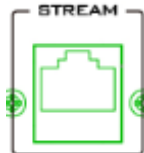

## 3. Stream Port

The stream port allows the user to establish direct connection between the notebook computer and the SHOWCAST 100 in order to access the built-in streaming encoder or connect the streaming encoder to any local area network.

**Note:** See [Chapter 6 Video Streaming and Recording](#) for device configuration and operations.

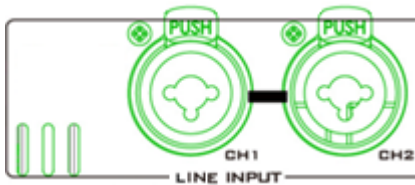

## 4. Audio Input – XLR Balanced (CH1/CH2)

Two channels of XLR Balanced Audio Input.

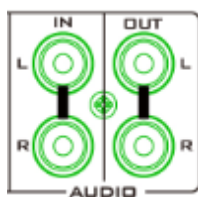

## 5. Audio Input/Output – Stereo RCA (Left/Right)

Audio IN connects an unbalanced analog audio source (stereo).

Audio OUT delivers unbalanced analog audio to an audio destination device.



## 6. TALLY Output Port

Sends **Red** and **Green** tally signals to each channel.

**Red** indicates On-Air, and **Green** indicates next camera source. Tally output port can connect other Datavideo peripheral devices such as ITC-100, ITC-200, AM-100 or other monitor models, allowing the peripheral device to communicate with the SHOWCAST 100 or send tally signal to be displayed on the monitor.

See [Appendix 1](#) for physical pin connections and [Section 3.5](#) for [Tally Mode](#) selection.



## 7. DVIP

DVIP port connects the SHOWCAST 100 to an Ethernet switcher or router for remote control of multiple PTZ cameras.

See [Chapter 4](#) for guidance on accessing the DVIP settings and connecting multiple Datavideo PTZ cameras via DVIP.



## 8. RS-232/422 REMOTE

The remote ports relay serial control signals between the camera in use and SHOWCAST 100 via RS-232 or RS-422 interface, which is selectable through the [Setup Menu](#).

You will need a custom Ethernet cable to establish connection. See [RS-232/422 Pinouts](#) for more information.



## 9. USB F/W Upgrade Port

USB port for firmware upgrade. Please refer to [Appendix 3 Firmware Upgrade](#) for details.



## 10. DC IN

DC in socket connects the supplied 12V PSU.



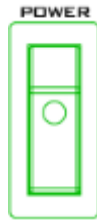

### 11. Power Switch

Power switch ON/OFF





### 12. Grounding Terminal



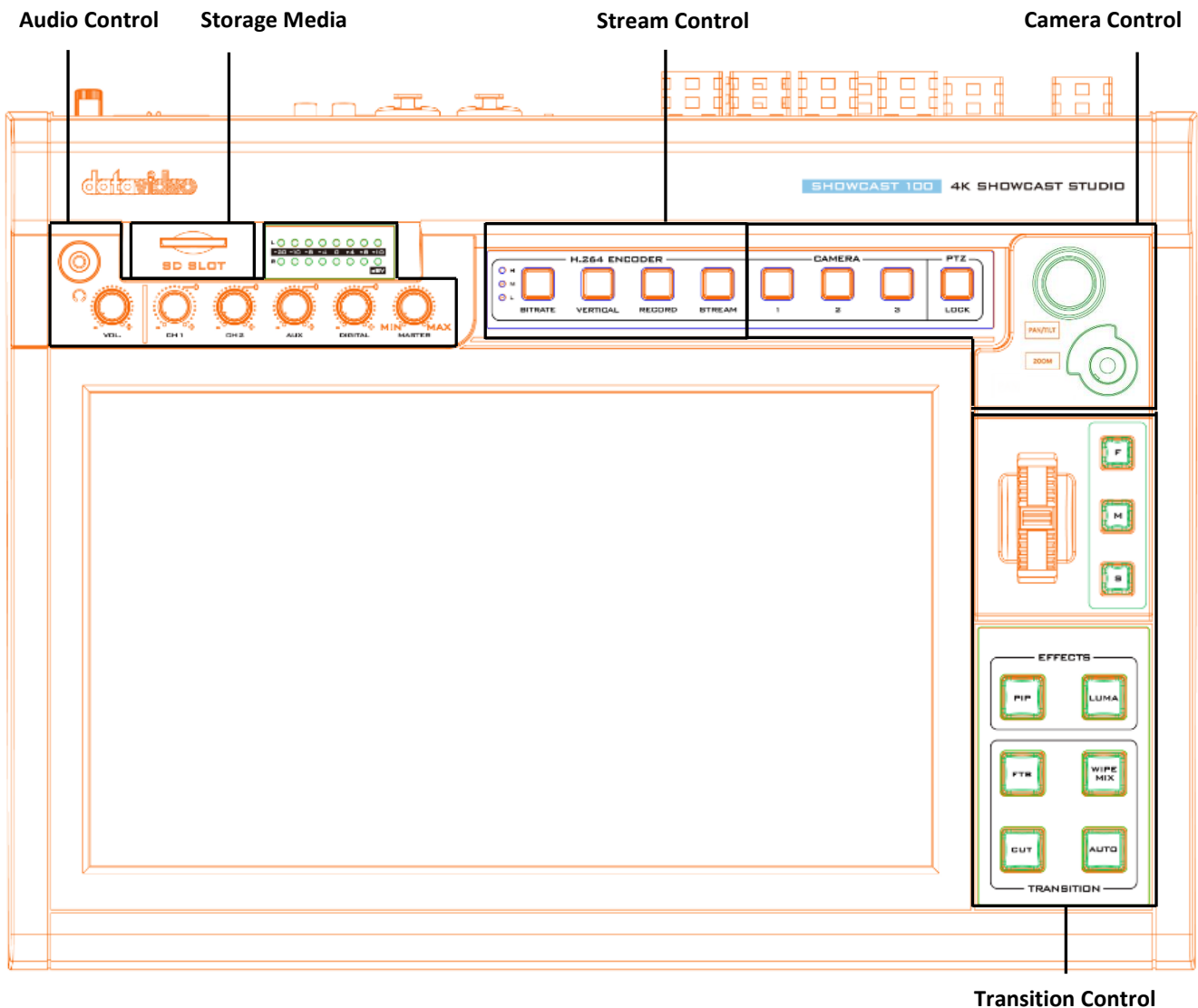

When connecting this unit to any other component, make sure that it is properly grounded by connecting this terminal to an appropriate point. When connecting, use the socket and be sure to use wire with a cross-sectional area of at least 1.0 mm<sup>2</sup>.

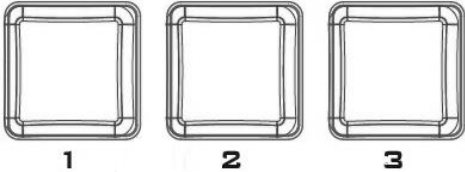
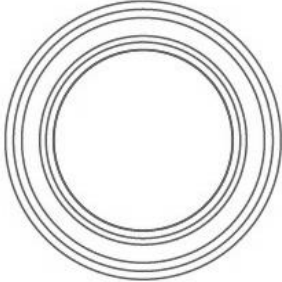

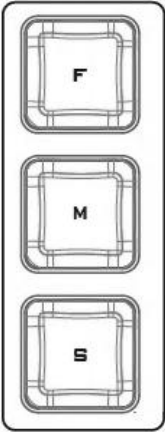

## 2.2 Switcher Keyboard Panel

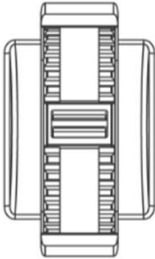



Camera Control	Audio Control
Camera channel selection buttons	Volume adjustment sliders (CH1/CH2/AUX/Digital/Master)
Joystick – PAN/TILT	Headphone jack
ZOOM Knob	Headphone volume control knob
Speed selection buttons (F/M/S)	Audio meter
PTZ LOCK button	
Transition Control	Stream Control
Scroll wheel	Bitrate button
PIP Keyer Enable/Disable button	H/M/L LED indicators
Luma Keyer Enable/Disable button	Record button
Fade-to-Black (FTB) Enable/Disable button	Stream button
WIPE/MIX Enable/Disable button	Vertical button
CUT Enable/Disable button	Storage Media
Auto Transition Enable/Disable button	SD card slot
Camera Control	
	<p><b>Camera Channel Selection Buttons</b> Press to select the camera that you would like to control. You can control up to three connected cameras on the SHOWCAST 100.</p>
	<p><b>Joystick – PAN / TILT</b> <b>PAN</b> – Move the joystick left or right to pan the selected PTZ camera head. <b>TILT</b> – Move the joystick up or down to tilt the selected PTZ camera head.</p> <p><b>Note:</b> Before attempting to use the joystick to PAN or TILT a selected camera, first make sure the <b>LOCK</b> button is not enabled. If the <b>LOCK</b> button LED is ON, the joystick is locked; press the <b>LOCK</b> button to unlock the joystick.</p>
	<p><b>ZOOM Knob</b> <b>ZOOM</b> – Turn the zoom knob clockwise or anti-clockwise to have the selected PTZ camera zoom in or out.</p> <p>Note: Make sure the <b>LOCK</b> button is not enabled. If the <b>LOCK</b> button LED is ON, the knob is locked; press the <b>LOCK</b> button to unlock the knob.</p>

	<p><b>Speed Selection Buttons</b> The speed at which the selected camera moves can be chosen by pressing one of the three speed buttons.</p>
	<p><b>PTZ Lock Button</b> When enabled, the joystick and the zoom knob will be in the lock state. To resume their functional status, simply press the button once to unlock.</p>
<b>Transition Control</b>	
	<p><b>Scroll Wheel</b> Roll the <b>scroll wheel</b> up or down to perform a manually controlled transition from the current program source to the selected preview source. The selected transition effect such as wipe or mix can be used. When the <b>scroll wheel</b> has travelled as far as it can go, the transition between sources is complete. Please note that the <b>scroll wheel</b> can be operated bi-directionally.</p>
	<p><b>CUT Button</b> Pressing the <b>Cut</b> button performs immediate manual switch between the PVW and PGM views without the transition effect.</p>
	<p><b>AUTO Button</b> Pressing the <b>Auto</b> button automatically transitions the <b>PVW</b> and <b>PGM</b> views according to the selected speed and the configured transition effect. Transition speed can be set in the <a href="#">Start</a> menu.</p>

	<p><b>FTB</b>          Fade To Black, this button fades the current program video to black. When pressed again it acts in reverse from complete black to the currently selected program video source. Transition speed can be set in the <a href="#">Start</a> menu.</p>
	<p><b>PIP</b>          Pressing the PIP button enables picture in picture view which puts the selected Sub Video Source in a window on the Main Program view, with control over window size and placement. For PIP configuration, please refer to the <a href="#">PIP</a> section.</p>
	<p><b>LUMA Keyer</b>          Pressing the <b>LUMA</b> button shows the luma key source on the PGM output and enables the luma key effect, however, the luma key effect cannot be previewed on the Multiview screen.</p>
	<p><b>WIPE/MIX</b>          A <b>MIX</b>, also known as a dissolve, is a transition wherein the Program video is replaced by the Preview video at a smooth rate, and at the same time.</p> <p>A <b>WIPE</b> transition moves from one video to another with a sliding animation, making it look like the video image is literally wiped away to reveal the next.</p> <p>First use the OSD menu to select the WIPE or MIX effect (see <a href="#">Section 3.1</a>) then press the <b>WIPE/MIX</b> button to start video transition with the enabled effect. Transition speed can be set in the <a href="#">Start</a> menu.</p>
<b>Audio Control</b>	
	<p><b>Volume Adjustment Knobs</b>          The five volume adjustment knobs control audio levels of the audio I/O.</p> <p>CH1: LINE CH1 input          CH2: LINE CH2 input          AUX: RCA IN          Digital: HDMI IN          Master: Main audio output</p>

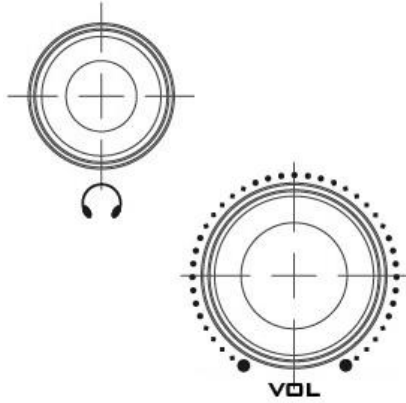

### Headphone Jack

Headphone jack accepts the mini jack plug of the stereo headphone type. The headphone volume is controlled by the Headphone volume adjustment slider.

The **Headphone Volume knob** adjusts the audio volume of the connected headphone.

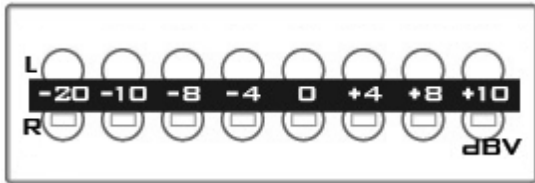

### MASTER OUT Meter

The LED style meters show the audio signal strength at the Main Program Audio Output. The signal strength is determined by the level set with the Master OUT slider. The LEDs turn red at +10 dBv to indicate clipping distortion.

Audio Volume (dBV)	-20		-10		-8		-4		0		+4		+8		+10	
LED Color	G		G		G		G		G		Y		Y		R	
Range (dBV)	-20	-12	-11	-9.5	-8.5	-6.5	-5.5	-3	-2	1	2	5.5	6.5	8	9+	

**G: Green Y: Yellow R: Red**

## Stream Control



### RECORD

Press the **RECORD** button to enable video record mode. See [Section 6.4](#) for details.



### STREAM



Press the **STREAM** button to enable video stream mode. See [Section 6.4](#) for details.



### Vertical Button

Press the **Vertical** button to switch stream video orientation between **Portrait** and **Landscape modes**. See [Section 6.4](#) for details.

**Note: You can also switch video orientation via web user interface; see descriptions of the [Vertical](#) page for details.**

	<p><b>BITRATE</b> Use the <b>BITRATE</b> button to switch between <b>high (H)</b>, <b>medium (M)</b> and <b>low (L)</b> bitrates for <b>RECORD</b> and <b>STREAM</b> functions. See <a href="#">Section 6.4</a> for details.</p>
	<p><b>SD Card Slot</b> Insert an SD card into the SD card slot for video recording.</p> <p><b>Note that you should only use Class 10 SD card or above. See the Appendix, <a href="#">Recommended SD Cards</a>, for a list of SD cards recommended by Datavideo.</b></p> <p><b>Note: Do not remove SD card while it is being written as doing so may result in corrupted video files.</b></p>

## 2.3 Touch Screen Interface

In this section, an overview of the touch screen interface will be provided.

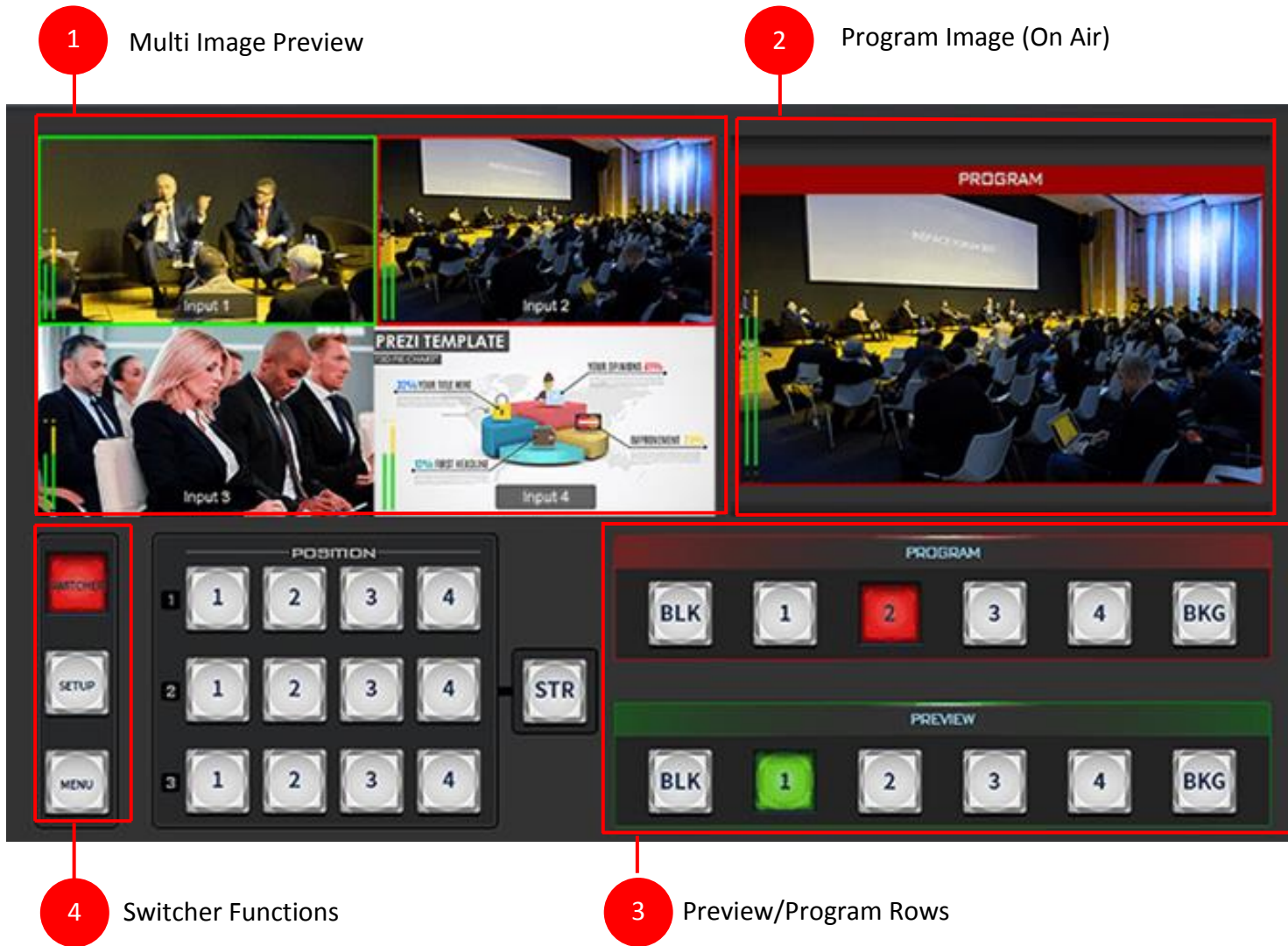



## Multi Image Preview (Multiview)

The Multi Image Preview or Multiview can be supplied from the four HDMI inputs. The Multiview will also display basic tally information on the respective screens by highlighting the live source image (program view image) with a red border, and the cued/next source image with a green border. You can change the program view image by simply tapping the input quadrants.

If PIP is enabled, the sub video source will always be highlighted with a red border.



## Program Image (On Air)

Next to the Multiview on the right is the Program view (HDMI OUT PGM 1 – 3) showing the video that is currently being streamed or recorded.



## Preview/Program Rows

The **Program row** of buttons is typically used to select the switcher's main Program output image. The selected source sent to the Program outputs will be **backlit Red** on this row. Simple cuts between sources can be performed on this row by pressing on the source number required for the next shot.

The **Preview row** of buttons is typically used to select the switcher's Preview or Next source output image. The selected source will be **backlit Green** on this row.



## Switcher Functions

The switcher functions are divided into three groups, namely switcher (camera presets), setup (camera setup) and menu (OSD menu).

### Switcher (Camera Presets)



The SHOWCAST 100 allows you to remotely control three cameras in use via RS-232/422 Remote ports. You can store up to four PTZ positions for each camera. Each preset button corresponds to one stored PTZ position. The button LED will be turned ON when selected.

To save a camera's PTZ position to a preset button, first press the STR button to enter the SHOWCAST 100 into the **STORE MODE**, which, when activated, allows the current PTZ position to be stored in a Channel Preset by pressing the corresponding preset button. Press the STR button again to exit the store mode.



### Setup (Camera Setup)

You can further access various other camera functions such as white balance, shutter, focus and iris via RS-232/422 interfaces.



#### White Balance

Certain light conditions can cause discoloration of your image. White balance allows you to adjust the color balance in order to produce the best image quality.

#### Auto (Automatic White Balance)

Push to enable automatic white balance adjustment.

#### One Push

The One Push White Balance mode is a fixed white balance mode that is automatically adjusted at the user's request. The One Push White Balance data is lost when the power is turned off, in other words, turning off the machine power resets the One Push White Balance setting.

The One Push White Balance mode can also be used for white balance calibration. Zoom in the camera lens on a white piece of paper which basically serves as a reference for what is white, then press the PUSH AUTO button to balance other colors accordingly.

**Note: If you are using the SHOWCAST 100 in conjunction with the PTC-140T, after the ONE PUSH key is pushed, wait for 5 to 6 seconds while the camera adjusts the white balance itself then proceed to the next action.**

#### Manual (Manual White Balance)

Push to enable manual white balance adjustment (R Gain/B Gain).



## Shutter

Press to open the shutter speed slider which allows you to adjust the shutter speed setting.



## Focus Adjustment

To manually control the **FOCUS** setting, first press the **MANUAL** button to enter the manual mode. The button LED will be turned ON to indicate that the manual mode is enabled.

Press the +/- buttons to set the focus.

If the **AUTO** button is enabled, the camera is in **AUTO FOCUS** mode.

## IRIS Adjustment

To manually control the **IRIS** setting, first press the **MANUAL** button to enter the manual mode. The button LED will be turned ON to indicate that the manual mode is enabled.

Press the +/- buttons to set the exposure.

If the **AUTO** button is enabled, the camera is in **AUTO IRIS** mode.

## Menu (OSD Menu)

Press the MENU button to access the switcher's OSD menu. See [Chapter 3 OSD Menu](#) for details.

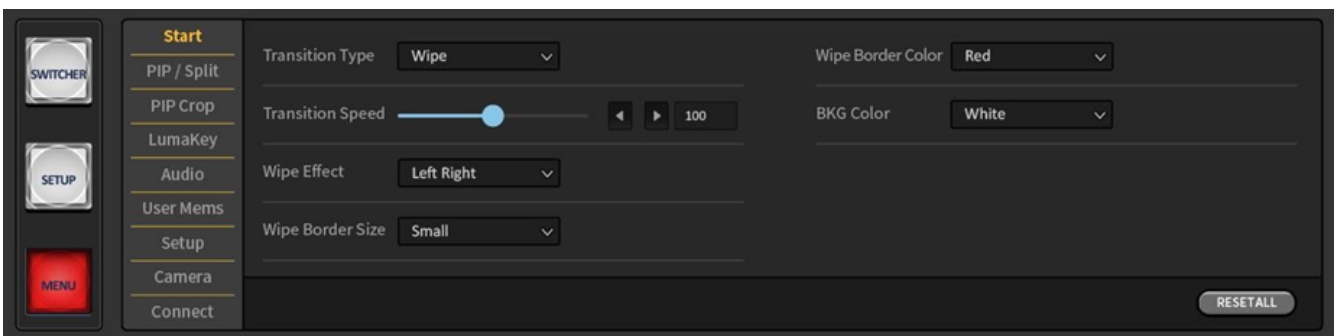

## Chapter 3 OSD Menu

The switcher's OSD menu allows the user to perform several configurations of video effects, such as picture-in-picture, luma key, etc. The user can also configure the audio settings in the Audio sub menu. The setup sub menu allows the user to set video output resolution, reset to factory default, and select the interface language.

### 3.1 Start

Main	Sub-Menu	Options or Values	Default Value
Start	Transition Type	MIX WIPE	Mix
	Transition Speed	1-200 frames	60 frames; the duration in second depends on the Program OUT resolution.
	WIPE Effect	Left Right Top Bottom Center	Left Right
	WIPE Border Size	OFF Small Middle Large	Small
	WIPE Border Color	White Yellow Cyan Green Magenta Red Blue Black	Red
	BKG Color	White Yellow Cyan Green Magenta Red Blue Black	White
	WIPE Rev.	Normal Rev	Normal

#### Transition Type

The SHOWCAST 100 provides two types of transition effect, which are cross dissolve (MIX) and WIPE. The default setting is **MIX**.

#### Transition Speed

The **Transition Speed** allows the user to set the **MIX** or **WIPE** effect duration, in frames. If the **Transition Speed** is set to a value of 60 then the transition will take effect over a period of 1 second if the

progressive video is chosen and 2 seconds if the interlaced video is chosen. When the **Scroll Bar** is pushed, the transition will take place at the current **Transition Speed** defined by the user.

### **Wipe Effect**

On the SHOWCAST 100, there are three wipe effects available for the user to choose. The three wipe directions are **left to right**, **top to bottom** and **center out**. The default is left to right.

### **WIPE Border Size**

The **WIPE Border Size** generally allows the user to select an appropriate border width. Setting the **WIPE Border Size** to OFF turns the border off. Setting the border size to small selects a thin border; middle will yield a medium size width; large is the maximum wipe border width.

### **WIPE Border Color**

Use this option to select a color for your wipe border. The available colors are listed as follows:

- White
- Yellow
- Cyan
- Green
- Magenta
- Red
- Blue
- Black

### **BKG Color**

Use this option to assign a color to the **BKG** button. The available colors are listed as follows:

- White
- Yellow
- Cyan
- Green
- Magenta
- Red
- Blue
- Black

### **WIPE Rev.**

Use this option to set the WIPE direction. You can select the normal direction or rev to reverse it. The default is normal direction.

## **3.2 PIP / Split**

Activating **PIP** mode (Picture-In-Picture) places a sub window on the **PGM** or **PVW** screen. The **Split** mode, once enabled, splits the PROGRAM output display into two windows with the PGM OUT shown on the left and the split source shown on the right.

The **PIP/Split** sub menu allows you to configure various settings of the PIP and Split windows.

**Note: When PIP and Lumakey features are enabled at the same time, the lumakey source will be on top of the PIP source. The layer order cannot be changed.**

Main	Sub-Menu	Options or Values	Default Value
PIP/Split	PIP Source	Black Input 1 Input 2 Input 3 Input 4 Background Color Bar	Input 2
	PIP Size	1-100%	30%
	Position X	-50% - +50%	20%
	Position Y	-50% - +50%	10%
	Split Source	Black Input 1 Input 2 Input 3 Input 4 Background Color Bar	Input 2
	Border Size	OFF Small Middle Large	Small
	Border Color	White Yellow Cyan Green Magenta Red Blue Black	Red
	PIP/SPLIT Mode	PIP Split	PIP
	PGM	ON/OFF	OFF
PVW	ON/OFF	OFF	

### PIP Source

Select a PIP source from the list below:

- Black
- Input 1
- Input 2
- Input 3
- Input 4
- Background
- Color Bar

### PIP Size (PIP Window Size)

The PIP window size ranges from 1 to 100 with 1% being the smallest and 100 being the largest. Therefore 50% would represent a PIP window which is half the size of the background image. 100% would see the PIP window totally cover the background image unless offset to one side.

## **Position X**

Adjusting **Position X** moves the PIP window horizontally. Decrementing **Position X** moves the PIP window left and incrementing **Position X** moves the PIP window right.

## **Position Y**

Adjusting **Position Y** moves the PIP window vertically. Decrementing **Position Y** moves the PIP window down and incrementing **Position Y** moves the PIP window up.

## **Split Source**

The **Split** mode, once enabled, splits the PROGRAM output display into two windows with the PGM OUT shown on the left and the split source shown on the right. The Split source, i.e. the program out view, can be selected from the list below:

- Black
- Input 1
- Input 2
- Input 3
- Input 4
- Background
- Color Bar

## **Border Size**

The **Border Size** generally allows the user to select an appropriate PIP border width. Setting the **Border Size** to OFF turns the PIP border off. Setting the border size to small selects a thin border; middle will yield a medium size width; large is the maximum PIP border width.

## **Border Color**

The user is allowed to assign a PIP border color. The available colors are listed as follows:

- White
- Yellow
- Cyan
- Green
- Magenta
- Red
- Blue
- Black

## **PIP/Split Mode**

Selecting **PIP** places a sub window on the **PGM** or **PVW** screen. The **Split** mode, once enabled, splits the PROGRAM output display into two windows with the PGM OUT shown on the left and the split source shown on the right.

## **PGM**

Turning ON PGM places the PIP window on the **PGM** screen.

## **PVW**

Turning ON PVW places the PIP window on the **PVW** screen.

### 3.3 PIP Crop

The PIP Crop basically adjusts the PIP window borders. You can adjust each side individually (Left / Right / Top / Bottom) or all four sides at the same time (Size).

Main	Sub-Menu	Options or Values	Default Value
PIP Crop	Size	0 – 100%	0
	Left	0 – 100%	0
	Right	0 – 100%	0
	Top	0 – 100%	0
	Bottom	0 – 100%	0

The PIP Crop sub-menu options are described below:

- **Left** – Adjusts the position of the left edge of the PIP window.
- **Right** – Adjusts the position of the right edge of the PIP window.
- **Size** – Adjusts the PIP image crop size.
- **Top** – Adjusts the position of the top edge of the PIP window.
- **Bot** – Adjusts the position of the bottom edge of the PIP window.

### 3.4 Lumakey

Keyer of the SHOWCAST 100 provides the user with the capability of luma keying.

**Note: When PIP and Lumakey features are enabled at the same time, the lumakey source will be on top of the PIP source. The layer order cannot be changed.**

Main	Sub-Menu	Options or Values	Default Value
Lumakey	Lumakey Source	Black Input 1 Input 2 Input 3 Input 4 Background Color Bar	Input 2
	Mode	Black White	Black
	Cleanup Level	0 – 100	20
	Transparency	0 – 64	64
	PGM	ON/OFF	OFF
	PVW	ON/OFF	OFF

#### Lumakey Source

Lumakey source is where you can select the image for luma keying. The available sources are listed as follows:

- Black
- Input 1
- Input 2
- Input 3
- Input 4
- Background

- Color Bar

## Mode

There are two modes available on the Luma Keyer. Select Black if the image is on a black background and white if the image is on a white background.

## Cleanup Level

The **Cleanup Level** allows the user to fine tune the effect of the luma key. The default value is 20.

## Transparency

Use this option to adjust the transparency of the overall foreground key image.

## PGM

Turning ON PGM applies lumakey to the **PGM** screen.

## PVW

Turning ON PVW applies lumakey to the **PVW** screen.

## 3.5 Audio

This option allows the user to configure various audio settings such as muting HDMI output audio, setting the audio type, selecting your tally type, etc.

Main	Sub-Menu	Options or Values	Default Value
Audio	Mute	OFF/ON	Off
	HDMI Input	Input 1-4 / Follow	Follow
	HDMI Group	Channel 1/2 Channel 3/4 Channel 5/6 Channel 7/8	Channel 1/2
	Level	Auto / SMPTE / EBU	Auto
	Tally Mode	Normal / Audio Mixer Mode	Normal
	Audio Delay (ms)	0 – 200	0

### Mute

The **Mute** allows you to turn ON/OFF the embedded audio component at the **HDMI-in**. The default is OFF.

### HDMI Input

Use this option to select the audio source. Selection of input 1-4 allows the SHOWCAST 100 to play the embedded audio source. If “**Follow**” is selected, the audio will enter Audio follow Video mode, i.e. playback of the audio of the output video.

### HDMI Group

The HDMI Group allows the user to assign the HDMI audio channel. The default audio channel pair is Channel 1/2. You can select any of the four audio channel pairs.

### Level

There are two different audio standards available for selection. The user can either select the EBU or SMPTE standard. By selecting AUTO allows the device to automatically detect the audio standard. When the image is 50 Hz, the audio follows EBU standard and when the image is 59.94/60 Hz, the audio follows SMPTE standard.



## Tally Mode

Tally output port generally sends two tally signals to each channel. In Datavideo products, **Red** indicates On-Air, and **Green** indicates next camera source.

The SHOWCAST 100 provides **two tally modes**:

**Normal:** With the normal mode enabled, tally lights of all camera sources displayed on the PGM monitor will be turned ON (Red). These sources include PGM, PIP and Key sources. As the next video starts to be seen on the PGM monitor while transition is in progress, tally light of the PVW source camera will also turn red.

**Audio Mixer:** If the Audio Mixer mode is selected, only tally light of the PGM source selected on the PGM row will be turned ON (Red). While transition is in progress, the tally light colors will remain unchanged. The tally light colors will only switch (red ↔ green) after transition of the PGM and PVW views is complete.

## Audio Delay

Use this option to adjust the audio delay which ranges from 0 – 200 milliseconds.

## 3.6 User Mems

In “**User Mems**”, the user is allowed to **load** previously saved switcher settings and **save** the currently configured switcher settings.

Main	Sub-Menu	Options or Values	Default Value
User Mems	Load Memory	Load User 1-6	
	Save Memory	Save User 1-6	

### Load Memory

Load the saved setting by selecting the desired memory location.

### Save Memory

Save the current setting by selecting the desired memory location.

## 3.7 Setup

In the “**Setup**” menu, the user can change the **output resolution**, reset the SHOWCAST 100 to its **Factory Default** values, choose the preferred OSD menu **language**, **upgrade firmware** and view the **current firmware versions**.

Main	Sub-Menu	Options or Values	Default Value
Setup	PGM Out Res.	3840x2160p/60	3840x2160p/59.94 Hz
		3840x2160p/59.94	
		3840x2160p/50	
		3840x2160p/30	
		3840x2160p/29.97	
		3840x2160p/25	
		3840x2160p/24	
		3840x2160p/23.98	
		1920x1080p/60	
		1920x1080p/59.94	
		1920x1080p/50	
		1920x1080p/30	

Main	Sub-Menu	Options or Values	Default Value
		1920x1080p/29.97 1920x1080p/25 1920x1080p/24 1920x1080p/23.98 1920x1080i/60 1920x1080i/59.94 1920x1080i/50 1280x720p/60 1280x720p/59.94 1280x720p/50	
	STREAM Out Res.	1920x1080p/60 1920x1080p/59.94 1920x1080p/50 1920x1080p/30 1920x1080p/29.97 1920x1080p/25 1920x1080p/24 1920x1080p/23.98 1280x720p/60 1280x720p/59.94 1280x720p/50	1920x1080p/59.94 Hz
	MV Mode	Quad View Mode Portrait Mode	Quad View Mode
	BLK Button Position	◀ BLK BLK ▶	◀ BLK
	9:16 Safety Marker	ON OFF	OFF
	Output Format	RGB YUV444 YUV422	YUV422
	Save Setup	[Save]	
	Factory Default	[Reset]	
	Language	English Simplified Chinese Traditional Chinese	
	Firmware Version	V 2.90 BL: 1.4 SP: 1.2 KB: 1.14	
	Firmware Upgrade	[Update]	

### PGM Out Res.

In **PGM Out RES.**, the user is allowed to select an appropriate **PROGRAM** output resolution. The available resolutions are listed as follows:

- 2160p/60
- 2160p/59.94
- 2160p/50

- 2160p/30
- 2160p/29.97
- 2160p/25
- 2160p/24
- 2160p/23.98
- 1080p/60
- 1080p/59.94
- 1080p/50
- 1080p/30
- 1080p/29.97
- 1080p/25
- 1080p/24
- 1080p/23.98
- 1080i/60
- 1080i/59.94
- 1080i/50
- 720p/60
- 720p/59.94
- 720p/50

Once done, simply go to “**Save Setup**” to confirm the selected output resolution.

**Note: Please make sure input and output resolutions are identical to avoid unexpected errors.**

### **Stream Out Res.**

In **Stream Out RES.**, the user is allowed to select an appropriate **MULTIVIEW** output resolution. The available resolutions are listed as follows:

- 1080p/60
- 1080p/59.94
- 1080p/50
- 1080p/30
- 1080p/29.97
- 1080p/25
- 1080p/24
- 1080p/23.98
- 720p/60
- 720p/59.94
- 720p/50

Once done, simply go to “**Save Setup**” to confirm the selected output resolution.

### **MV Mode**

Set the Multiview mode. Select Quad View to enable 2x2 Multiview. The Portrait mode enables a 4x1 Multiview layout.

## Quad View Mode

HDMI 1 (CH1)	HDMI 2 (CH2)
HDMI 3 (CH3)	HDMI 4 (CH4)

## Portrait Mode

HDMI 1 (CH1)	HDMI 2 (CH2)	HDMI 3 (CH3)	HDMI 4 (CH4)
--------------	--------------	--------------	--------------

## BLK Button Position

You can also change the BLK button position to either the rightmost or leftmost button of the Program/Preview rows.

- ◀ BLK: Sets the BLK button to the rightmost position.
- BLK ▶: Sets the BLK button to the leftmost position.

## 9:16 Safety Marker

Turning ON the safety marker sets the safety zone display, which is the standard viewing range of the recorded video.

## Output Format

Select a color encoding system for your video output. The available color formats are listed below:

- RGB
- YUV444
- YUV422

## Save Setup

Select “Save” to save the current configuration.

## Factory Default

Once selected, the factory default settings will be restored. The device will start the factory reset process in 2 to 3 seconds.

## Language

The available OSD menu languages are **English**, **Traditional Chinese** and **Simplified Chinese**.

## Firmware Version

This displays the device’s current firmware version.

## Firmware Upgrade

See [Appendix 3](#) for firmware upgrade procedure.

## 3.8 Camera

In the “Camera” menu, the user will be able to change the camera name, view camera information and perform some basic camera settings. The basic camera settings include the video format, mirror mode, PAN/TILT direction and etc.

Main	Sub-Menu	Options or Values	Default Value	
Camera	Scan	[Scan]		
	Camera	Camera 1 Camera 2 Camera 3	Camera 1	
	Tally Mapping	Input 1 Input 2 Input 3 Input 4	Input 1	
	Camera Control	DVIP RS-422 RS-232	DVIP	
	Baud Rate	9600 19200 38400 57600 115200	115200	
	IP		The linked camera’s IP address. Will show “NONE” if no camera is detected.	
	Camera Info	Vendor ID		These camera info will be displayed; will show “None to link!” if no camera is detected.
		MB Version		
FPGA Version				
Motor Version				
DVIP Version				

Main	Sub-Menu	Options or Values	Default Value
	Model		Shows the camera's model number.
	Video Format	2160p/60 2160p/59.94 2160p/50 2160p/30 2160p/29.97 2160p/25 2160p/24 2160p/23.98 1080p/60 1080p/59.94 1080p/50 1080p/30 1080p/29.97 1080p/25 1080p/24 1080p/23.98 1080i/60 1080i/59.94 1080i/50 720p/60 720p/59.94 720p/50	
	Mirror Mode	Off V H H+V	
	Joystick Pan	Normal Reverse	
	Joystick Tilt	Normal Reverse	
	R-Gain	0-255	
	B-Gain	0-255	
	Tally LED	Off Red Green	
	Menu		
	Enter		

### Scan

Select to scan for the connected cameras.

### Camera

This provides a list of the connected cameras. Select one to configure.

### Tally Mapping

Select and assign a tally channel to the selected camera from the list below:

- Input 1
- Input 2
- Input 3
- Input 4

## Camera Control

Select a camera control protocol from the list below for connecting the cameras.

- DVIP
- RS-422
- RS-232

## Baud Rate

If RS-422 or RS-232 is selected, select a baud rate from the list below:

- 9600
- 19200
- 38400
- 57600
- 115200

## IP

IPs of the cameras will be listed here if connected via DVIP.

## Camera Info

This field provides camera information display such as **Vendor ID**, **MB Version**, **FPGA Version**, **Motor Version** and **DVIP Version**.

## Model

This field shows the model number of the selected camera.

## Video Format

This sets the video format of the selected camera. The available resolutions are listed as follows:

- 2160p/60/59.94/50/30/29.97/25/24/23.98
- 1080p/60/59.94/50/30/29.97/25/24/23.98
- 1080i/60/59.94/50
- 720p/60/59.94/50

## Mirror Mode

There are three types of mirror modes available:

- V: Vertical mirroring
- H: Horizontal mirroring
- H+V: Horizontal and Vertical mirroring

## Joystick Pan

You can select the normal PAN direction or reverse it.

## Joystick Tilt

You can select the normal TILT direction or reverse it.

## R-Gain

Adjust R-Gain to add or reduce the intensity of the red color.

## B-Gain

Adjust R-Gain to add or reduce the intensity of the blue color.

## Tally LED

**Tally LED:** You can either turn the tally light off or enable the red or green tally light.

## Menu

Tap to open the selected camera's OSD menu.

## Enter

Tap to select an OSD menu option.

## 3.9 Network

The “**Network**” menu allows you to select and enter SHOWCAST 100's DVIP port settings for connecting up to three Datavideo's PTZ cameras such as PTC-150.

Main	Sub-Menu	Options or Values	Default Value
Network	Address Mode	DHCP	
		Fixed IP	
	IP Address		
	Network Mask		
	Gateway		
	Primary DNS		
	Secondary DNS		
	MAC Address		
	Network Def		
	IP Save	[IP Save]	
	[Reset All]		

### Address Mode

In DHCP mode, the router automatically assigns the IP address to the device. If you want to manually configure the network settings, disable this option.

If the Fixed IP is selected, the static IP field will be activated for the user to manually enter the IP address. The static IP address is 192.168.1.XXX by default.

### IP Address

Manually enter the device's IP address if Fixed IP mode is selected.

### Network Mask

Fixed IP mode requires the network mask, which is 255.255.255.0 by default.

### Gateway

Fixed IP mode requires the default gateway, which is 192.168.1.254 by default.

### Primary DNS

Primary DNS is required in Fixed IP mode only but is optional.



**Secondary DNS**

Secondary DNS is required in Fixed IP mode only but is optional.

**MAC Address**

This shows the MAC address of the device.

**Network Def**

This resets the device's network settings.

**IP Save**

Select to save the new network settings.

## Chapter 4 DVIP

DVIP is a Datavideo proprietary communication protocol that allows the SHOWCAST 100 to remotely connect and control multiple Datavideo PTZ cameras such as PTR-10 MARK II, PTC-150/150T, etc.

To use this feature, you will have to first configure DVIP settings of the SHOWCAST 100 and the connected cameras using the DVIP Configuration Tool which can be downloaded from the official product pages to the PC. The DVIP Configuration Tool allows you to access and modify the device's DVIP settings from your PC. Depending on your network environment, you can either connect directly to the DVIP port using a fixed IP or via a router (DHCP).

In this chapter we will show you various features that the tool offers.

### 4.1 Setup

When new from the factory, the DVIP port is DHCP by default so connect the SHOWCAST 100's DVIP port to the router via an Ethernet cable and connect the laptop to the same router as depicted in the diagram below.

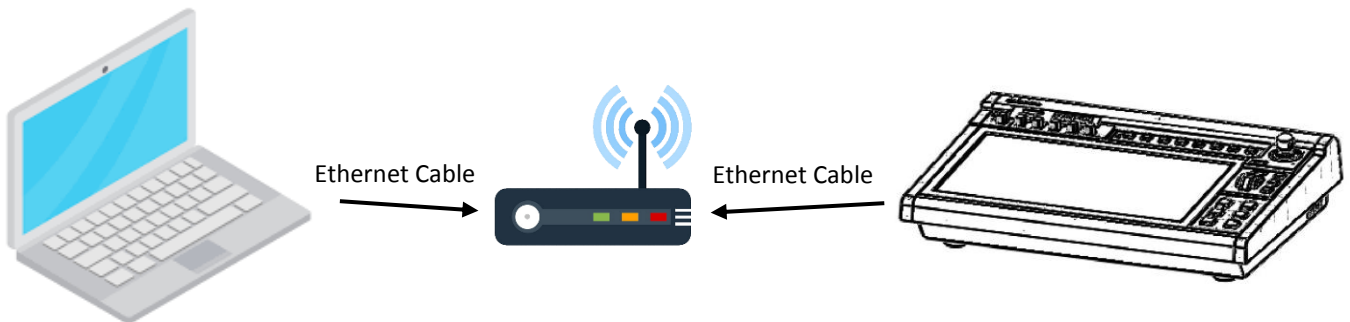

To access the SHOWCAST 100's DVIP settings, you will need to first download the DVIP Configuration Tool to the PC from the official product page then install it on the PC. Open the tool by double clicking the icon shown on the right.



In the next section, various features of the tool will be described.

### 4.2 Features

The DVIP Configuration Tool interface is shown below. You should see the number of DVIP devices connected as well as the name and MAC address of these devices as shown in the diagram below. Click any device to access and modify the network settings.

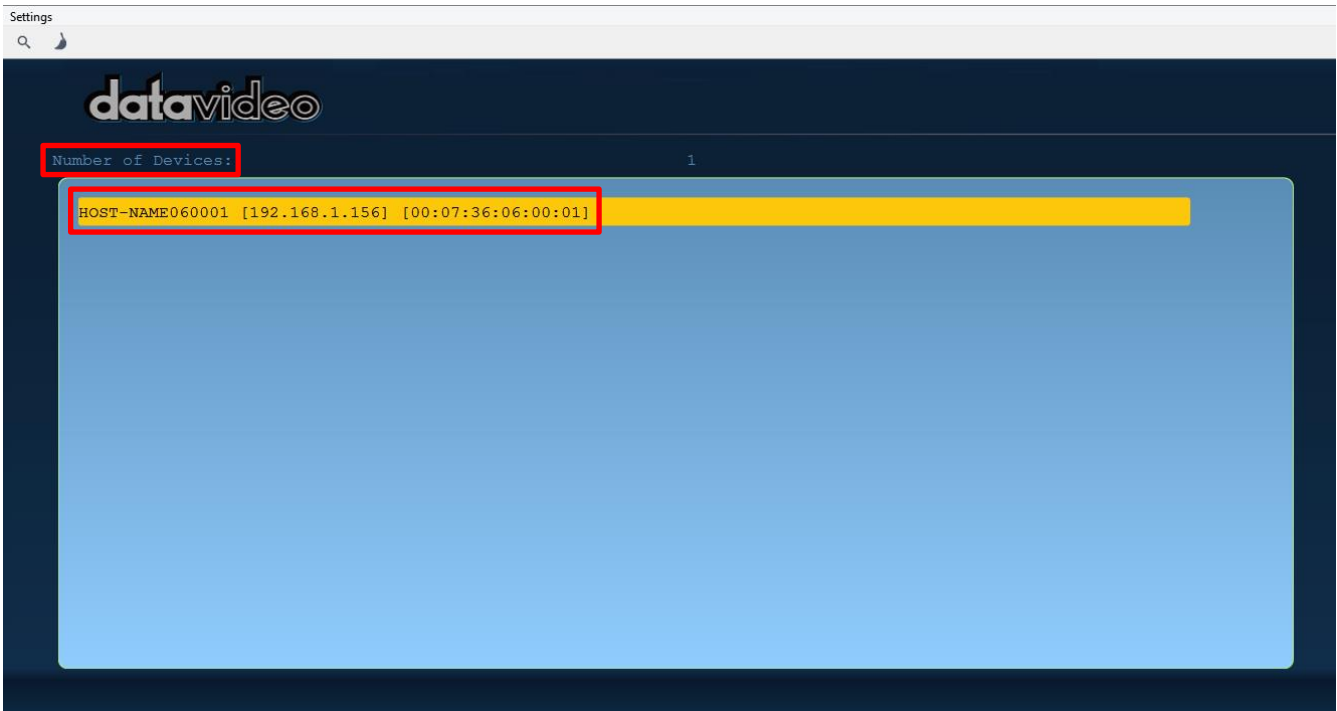

On the Network Setting page, you may change the device name by modifying the Host Name field. You will also be able to see the device model name, the MAC address and the IP address. You will not be allowed to modify the network settings if the device is in DHCP mode.

To manually assign an IP address to your device, simply select the “Using Fixed IP Mode” checkbox then enter a custom IP address, subnet mask, default gateway IP (optional), and primary and secondary DNS servers (optional).

The screenshot shows the Network Setting page. It has a light blue background. The fields are: Host Name (HOST-NAME060001), Model Name (PTC-150 (VID:0588, PID:3001)), MAC address (00:07:36:06:00:01), IP address (192.168.1.156). Below these is a checkbox for "Using Fixed IP Mode" which is unchecked. Below the checkbox are fields for Mask (255.255.255.0), Gateway (192.168.1.1), Primary DNS (192.168.1.1), and Secondary DNS (8.8.4.4). At the bottom are two buttons: "Default" (red) and "Save" (yellow).

Click the “**Save**” button to write the new information into the device. Right after the “**Save**” button is clicked, you will be able to see a prompt message at the top right corner to request for a device reboot. New settings will be applied after the reboot.

To reset, simply click the “**Default**” button.

## Device Search

Click the search icon to refresh the DVIP device list connected on the same network.



## Device Clear

Click the clear icon to clear the device list shown on the interface.



## Switch to Other Network Interfaces

To select other network interface cards, click Network → Network Card

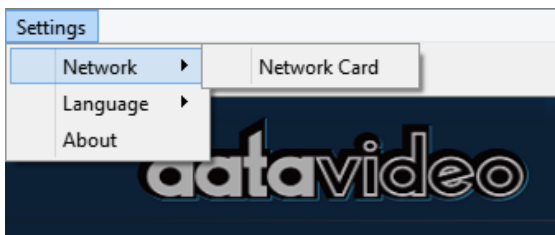

## Language Selection

The available interface languages are **Traditional Chinese**, **Simplified Chinese** or **English**

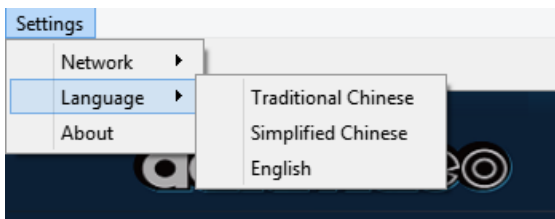

## About

Click “**About**” to see the tool information shown below.

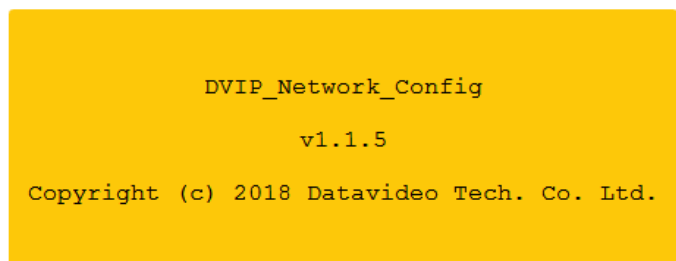

## 4.3 Example Setup

See the diagram below for an example system setup using DVIP.

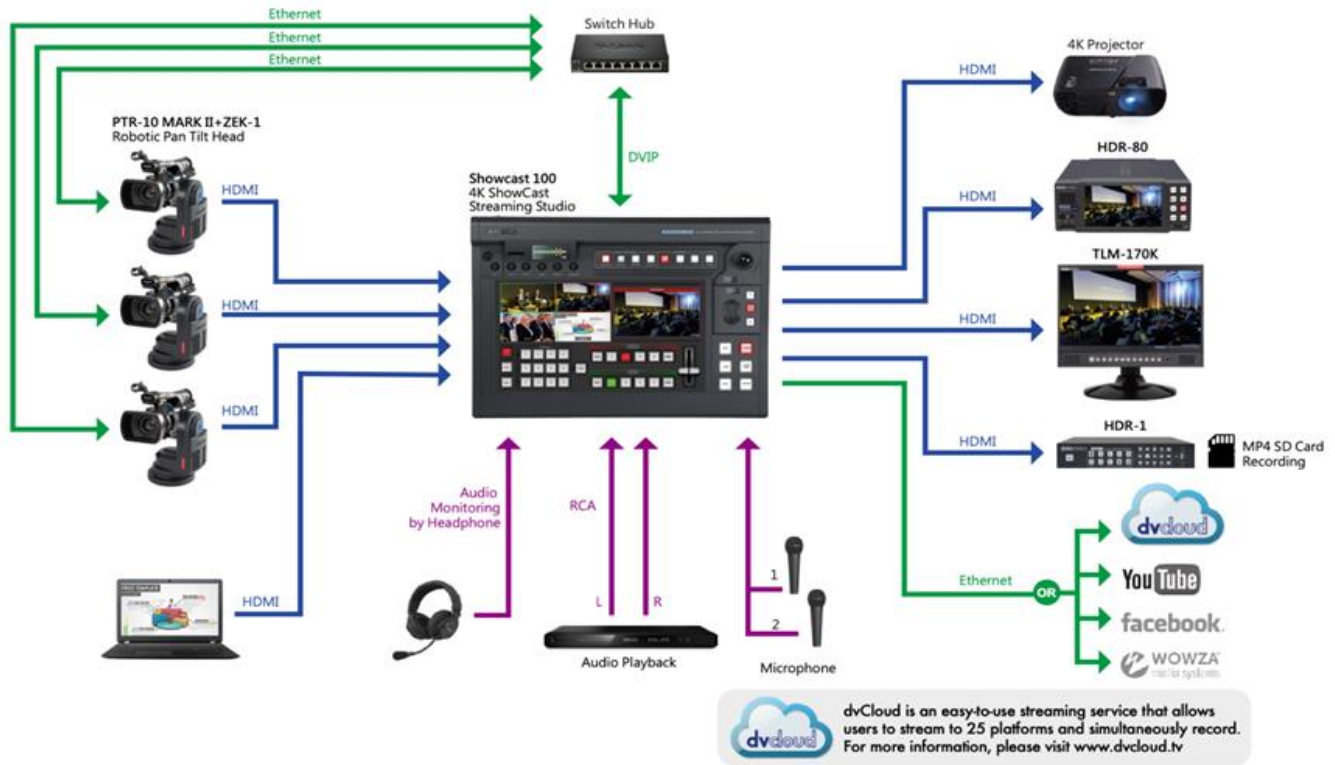

For illustrative purposes, we use PTR-10 MARK II in the above system setup. Follow the steps outlined below to initially configure the PTR-10 MARK II before moving it to an existing DHCP / LAN network.

1. First download the DVIP Configuration Tool from the product page to the PC and install it.
2. The PTR-10 MARK II usually has a default static IP address of 192.168.100.XXX. Using an RJ-45 Ethernet cable, connect the **DVIP port** of your PTR-10 MARK II to the PC assigned of an IP address with the same first three octets as the unit's default IP address.
3. Locate the DIP switch on your PTR-10 MARK II.

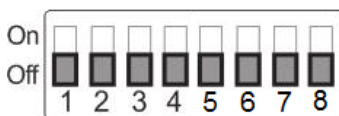

4. Set DIP Switch position 4 to ON.



5. On the PTR-10 MARK II, follow the OSD menu path Remote Control → Set DVIP → DVIP BAUD Rate and set **DVIP baud rate** to 115200.
6. Open the DVIP Configuration Tool on the PC.
7. At the startup screen, select your network interface card and click **“OK”**.

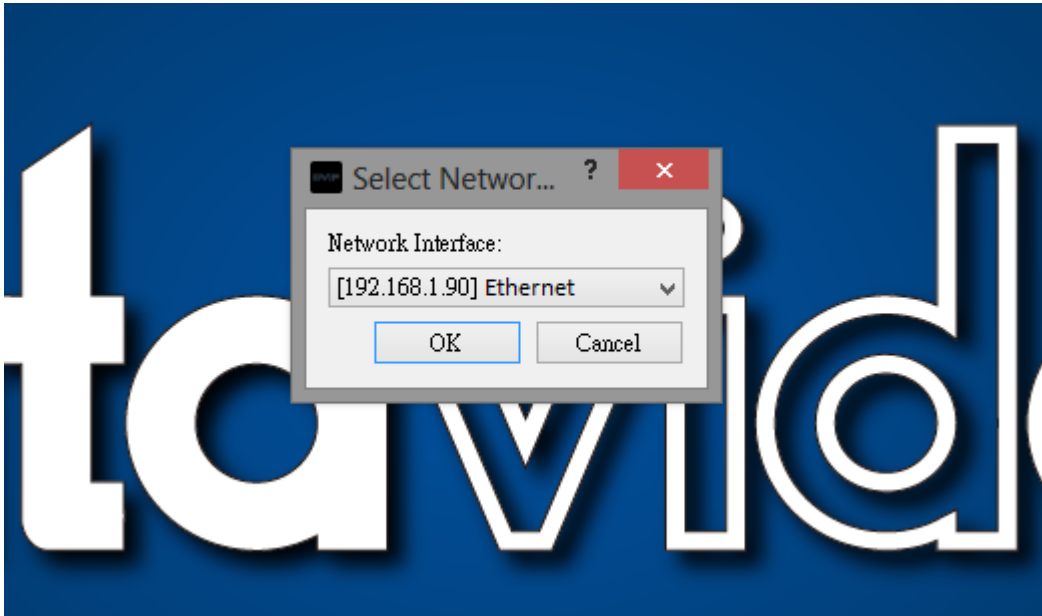

8. In the DVIP Device List, click the device name to view the Device Name, MAC address and IP address.

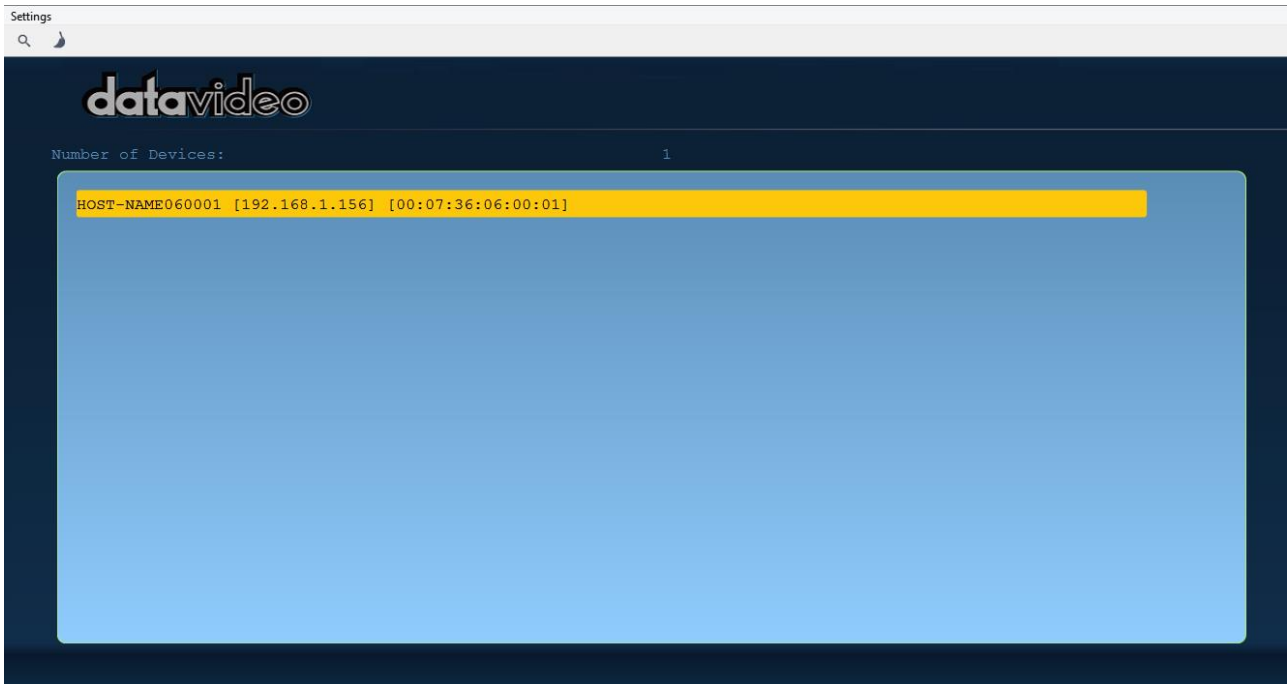

9. Set the network to DHCP by clearing the **“Fixed IP Mode”** checkbox then click the **“Save”** button to write the new settings into the device.

Host Name	HOST-NAME060001
Model Name	PTC-150 (VID:0588, PID:3001)
MAC address	00:07:36:06:00:01
IP address	192.168.1.156
<input type="checkbox"/> Using Fixed IP Mode	
Mask	255.255.255.0
Gateway	192.168.1.1
Primary DNS	192.168.1.1
Secondary DNS	8.8.4.4
	<input type="button" value="Default"/> <input type="button" value="Save"/>

10. Right after the “**Save**” button is clicked, you will be able to see a prompt message at the top right corner to request for a device reboot for the new settings to become effective.

11. Reboot the device to apply the new settings. Your device should connect in DHCP mode after it is successfully rebooted.

You can repeat the above steps or follow the alternative procedure outlined below to configure the SHOWCAST 100’s DVIP port.

1. On the touch screen interface, press the **MENU** button to open the OSD menu.
2. Tap the **Network** sub menu.
3. In **Address Mode**, select **DHCP** (In DHCP mode, the DVIP port will be automatically assigned an IP address upon connecting to a router).
4. Tap **IP Save** to save the new settings.

Lastly connect up to three PTR-10 MARK II and the SHOWCAST 100 to the same router after which you should be able to control and configure the cameras remotely on the SHOWCAST 100.

## Chapter 5 Applications

### 5.1 Placing a logo on the video using the lumakey

The SHOWCAST 100 allows the user to place a logo on the video using the lumakey. First, create a 1920x1080 (16:9) logo against a black or white background on a laptop. Once the logo is created, simply follow the steps outlined below to insert the logo layer.

**Note: If your logo consists mainly of dark colors, choose a white background; if the logo consists mainly of bright colors, choose a black background.**

1. Connect the laptop to the switcher's one of the **HDMI input ports (Inputs 1 to 4)**.
2. Then on the touch screen interface, press the **MENU** button to open the OSD menu.
3. Tap the **Lumakey** sub menu and set the "**Lumakey Source**" to the input that the laptop is connected to.
4. If the logo is against a black background, choose **Black Mode** (choose white if the background is white).
5. Set the "**Cleanup Level**" to 10 if the background is in total black.
6. "**Transparency**" is set to 64 if an opaque logo is used. The **Opaque** logo can be created by setting the "**Transparency**" to 64. **Semi-transparency** effect can be generated by setting the "**Transparency**" to a value between 0 and 64.
7. After the Logo is properly configured, turn on PGM to enable the logo on the Program screen or PVW to enable the logo on the Preview screen.
8. Exit the menu.



## Chapter 6 Video Streaming and Recording

The **SHOWCAST 100** allows the user to stream and record your program at the same time. From any SDI/HDMI input sources, the built-in video streaming server generates an H.264/265 encoded stream that is compliant with various protocols such as RTSP or RTMP. While encoding the video at bit rates appropriate for live streaming, the video streaming server concurrently records a high-quality MP4 file to an SD card.

**Note:** *The built-in video streaming server will be referred to as NVS-31 MARK IV in this manual.*

### 6.1 Network Connection and Device Search

To use the NVS-31 MARK IV's web user interface, you will have to first connect the SHOWCAST 100 to a network via the STREAM port. This section shows you how to connect to the network with or without a DHCP server, and describes ways to acquire the NVS-31 MARK IV's IP address.

#### **Default Fixed IP**

When new from the factory, the NVS-31 MARK IV is supplied with a default fixed IP address (**192.168.1.200**) which allows you to establish point-to-point connection with your laptop/PC. The following setup should allow you to log in to the web user interface and initially configure the device's various settings.

#### **System Requirements:**

- An RJ-45 Ethernet cable
- Windows 7/8/10 laptop or PC
- SHOWCAST 100
- IP Finder utility program (downloaded from the product page to the laptop)

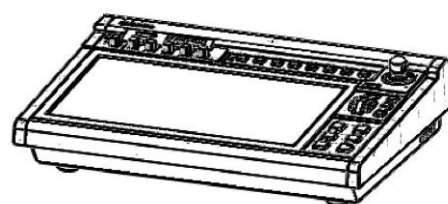
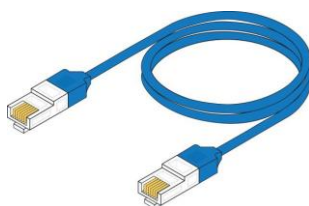

#### **Follow the procedure below to log in to the web user interface:**

1. Physically connect the Windows laptop's Ethernet port to the **STREAM** port via an Ethernet cable.
2. Turn on the laptop and set it to **static IP setup** within the **Windows Network and Sharing Centre**. In our example, the computer is given the following IP settings so that the computer matches the same IP range as the switcher.

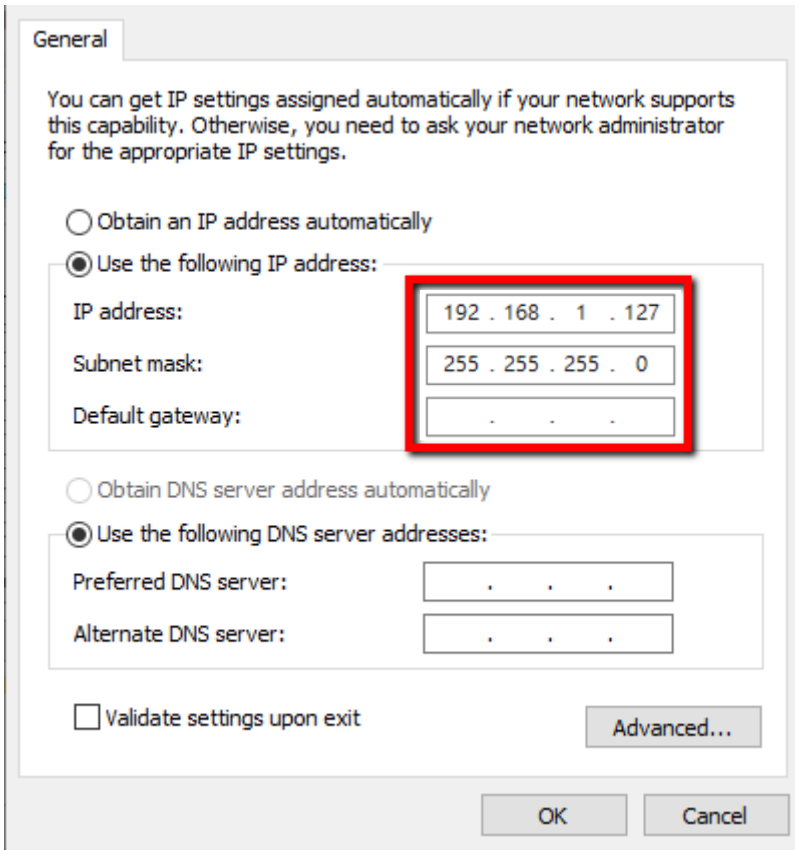

3. Turn on the SHOWCAST 100's power and the device should be turned ON in Static IP mode by default (**192.168.1.200**).
4. On the laptop, double click the IP Finder utility program icon to open the IP Finder interface. 
5. Click the **SCAN** button to search for NVS-31 MARK IV.

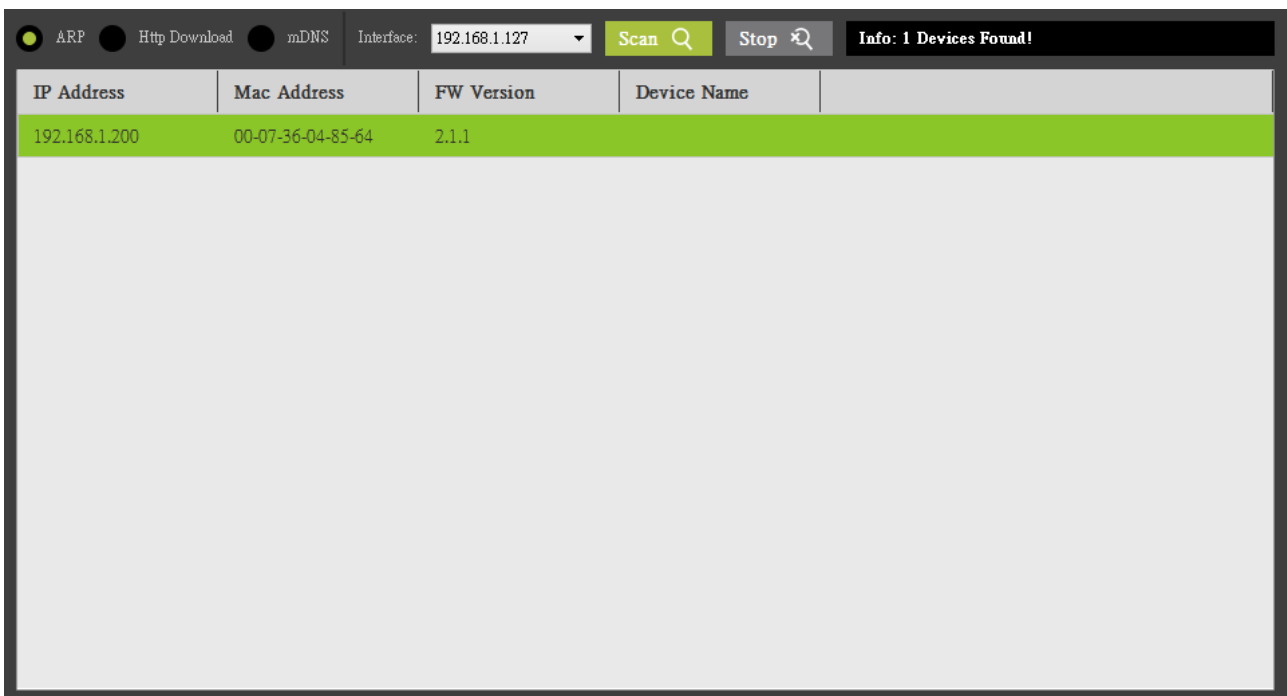

6. Double click the NVS-31 MARK IV's IP address, and your browser should open up with a login screen shown below. You can also manually enter the device IP address into the address bar of a browser on your laptop then hit the **ENTER** button.



7. Enter the login credentials (Username: admin/Password: 000000) to log in to the web UI shown below.

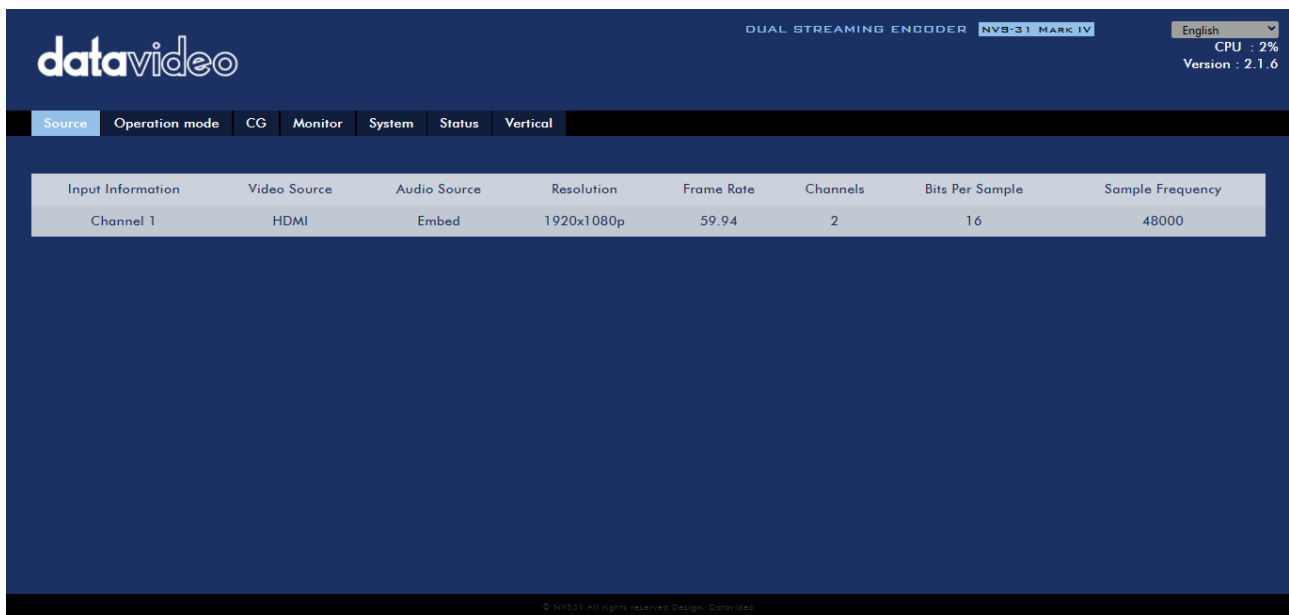

Brief descriptions of the tabs are provided as follows:

**Source:** View and configure various video sources.

**Operation Mode:**

- **Record:** Configure the two built-in recorders.
- **Streaming:** Configure the two built-in stream servers.

**CG:** Create textual or graphic layers ([Text](#), [News](#), [Graphic](#), [Logo](#) and [Animation](#)) on the videos.

**Monitor:** Set the HDMI output frame rate and volume of the embedded audio.

**System:** System settings include [network setting](#), [login credentials](#), [time setting](#), [firmware update](#), [disk formatting](#), [device name](#), [timeout duration](#), [reset](#) and [reboot](#).

**Note:** In **Networking Setting**, you will be allowed to enable/disable DHCP; see the following sections for details on connecting in the respective modes.

**Status:** View input, record, stream and disk status.

**Vertical:** Set the video display orientation.

### **Connecting to a DHCP Network (DHCP Mode)**

In DHCP mode, the NVS-31 MARK IV will be automatically assigned an IP address upon connection to the DHCP network.

Follow the procedure below to scan your DHCP network for NVS-31 MARK IV.

1. Connect the SHOWCAST 100's STREAM port to the network via an Ethernet cable.
2. Turn on the SHOWCAST 100's power and the NVS-31 MARK IV should be turned ON in DHCP.
3. Connect the laptop to the same network that the NVS-31 MARK IV is connected to and download the free IP Finder utility program.
4. Double click the IP Finder utility program icon to open the IP Finder interface.
5. Click the **SCAN** button to start searching for NVS-31 MARK IV.

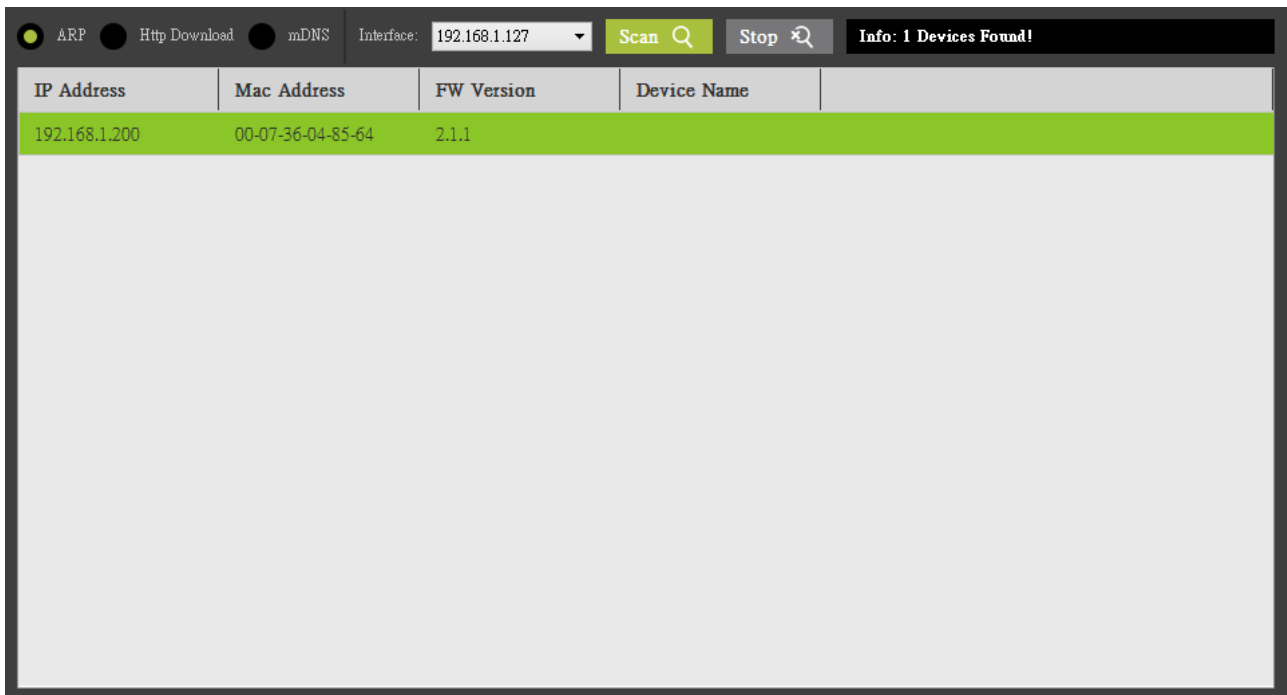

6. Double click the NVS-31 MARK IV's IP address, and your browser should open up with a login screen shown below. You can also manually enter the device IP address into the address bar of a browser on your PC then hit the **ENTER** button.



7. Enter the login credentials (Username: admin/Password: 000000) to log in to the web UI.

### **Connecting to a NON-DHCP Network (Static IP)**

Upon connection to a non-DHCP network, the NVS-31 MARK IV will not be assigned of any IP address. As such it is recommended that you manually assign a fixed IP address to the device or use the default IP address (**192.168.1.200**).

To configure the NVS-31 MARK IV from DHCP to a **static IP**, please follow the steps outlined below:

1. Connect the NVS-31 MARK IV's **STREAM** port to the network via an Ethernet cable.
2. Turn on the SHOWCAST 100's power and the device should be turned ON in DHCP.
3. Search for the NVS-31 MARK IV according to the method as detailed in the previous DHCP section. Once found, log in to the user interface on the web browser.
4. Open the system page by clicking the "**System**" tab on the home of the user interface.
5. In the "Network Setting" pane, disable the DHCP mode.
6. You will be allowed to manually enter the static IP address after the DHCP mode is disabled. Please note that the static IP is 192.168.1.200 by default.
  - Static IP: X.X.X.Y; the first three octets must be the same as your network. The least significant octet Y must be a number not used by any devices connected to the network.
  - Subnet Mask: 255.255.255.0
  - Default Gateway: Z.Z.Z.Z; same as the gateway IP of your router or switch.

**Note: Some router may require special gateway IP setting instead of the standard 192.168.1.1. Therefore, you should check the network properties on the PC before switching to the fixed IP mode. For example, some routers have a gateway IP of 192.168.1.254 and as a result, the default gateway and primary DNS fields must also be configured to 192.168.1.254.**

  - Primary DNS: Same as the default gateway IP, which, if causing issues, can be changed to 8.8.8.8 or 8.8.8.4 (Public DNS provided by Google).
7. After you've set the static IP, you can either establish point-to-point connection between NVS-31 MARK IV and your computer or connect to a network with the same IP range.

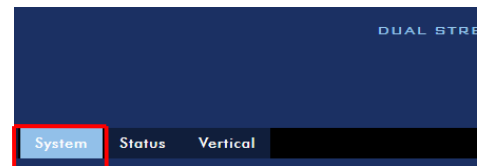

**Tip: If you forget or lose the IP address, do the following to reset the network settings.**

- Turn off SHOWCAST 100.
- Push the **RECORD** and **STREAM** buttons at the same time then turn ON the device power.

- Wait for about five seconds then release the buttons as soon as you see the **RECORD** and **STREAM** button LEDs light up.
- The IP address should be the default IP which is **192.168.1.200**.

### ***Troubleshooting the Network Connection***

Connect the **STREAM** port to the network then use the IP Finder utility program to scan for NVS-31 MARK IV. If not found, it is possible that your network is not assigning IP addresses. Reasons of this are outlined as follows:

- The Router or the DHCP server is not connected to the network.
  - New devices are blocked by the network administrator.
  - Anti-virus software or the firewall blocks the communication.
1. Solve the problem by trying the following:
    - Turn off the router, wait for 10 seconds then turn on the router again.
    - Reset the NVS-31 MARK IV's network setting to the factory default:
      - Turn off SHOWCAST 100.
      - Push the **Record and Stream** buttons simultaneously while turning on the SHOWCAST 100's power.
      - Wait for about five seconds and release the buttons as soon as you see the **RECORD** and **STREAM** button LEDs turned ON.
    - Reboot the PC.
  2. If the problem still persists, try the following ways:
    - Temporarily shut down the anti-virus software or firewall.
    - Make sure no other devices are connected to the LAN (wired or wireless) because this may result in IP conflicts.
  3. After trying all methods and if the problem is still not solved, the NVS-31 MARK IV offers the fixed IP feature that allows you to establish point-to-point connection to gain access to the device without a DHCP server. Please note that the NVS-31 MARK IV's default IP address is 192.168.1.200. Follow the steps outlined below.
    - Restore the NVS-31 MARK IV's default network settings.
      - Turn off the SHOWCAST 100.
      - Push the **Record and Stream** buttons simultaneously while turning on the device's power.
      - Wait for about five seconds then release the buttons as soon as you see the **RECORD** and **STREAM** button LEDs turned ON.
    - Connect your PC to NVS-31 MARK IV directly using an Ethernet cable (not necessarily a crossover cable).
    - Click START located at the bottom left corner of your PC screen.
    - On the text bar, enter Network Connections then click the icon that appears.
    - Double click the network adapter that connects your PC or laptop to the SHOWCAST 100.
    - Click the "**Properties**" button.
    - Select "**Internet Protocol Version 4 (TCP/IPv4)**" and click the "**Properties**" button.

- Check “**Obtain an IP address automatically**”.
- Enter IPv4 settings:
  - IP Address: 192.168.1.2
  - Subnet Mask: 255.255.255.0 (System default is 255.255.255.0)
  - Default Gateway: Not required for point-to-point connection.

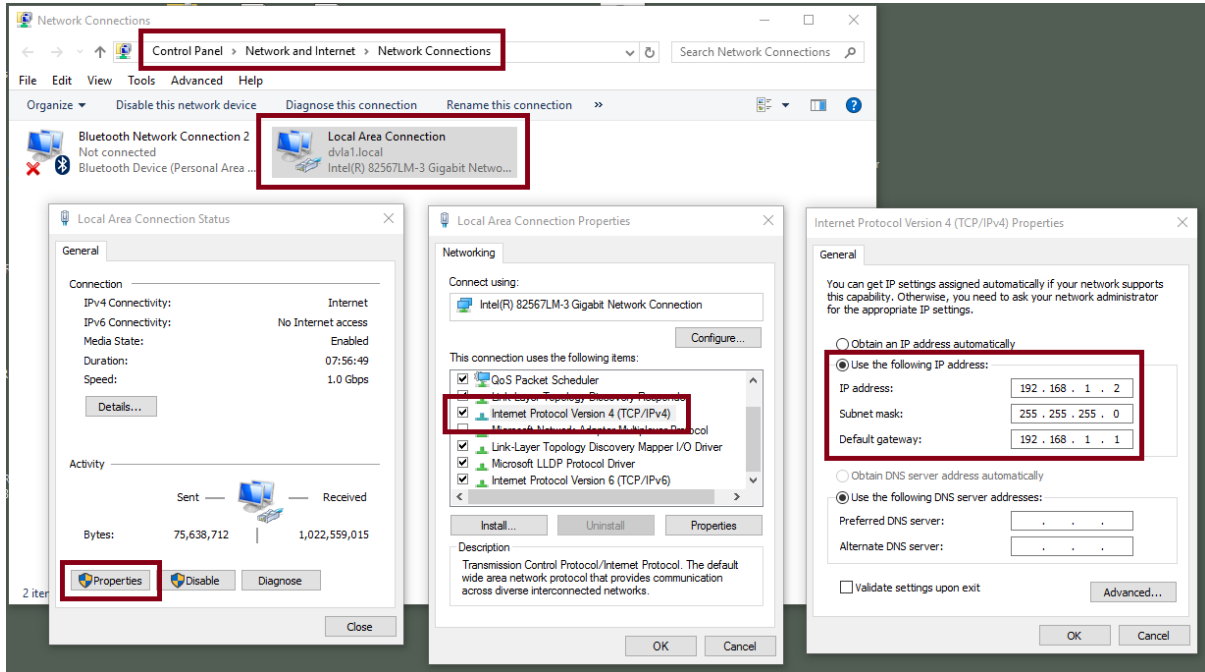

- You should be able to access the NVS-31 MARK IV via its default IP address (192.168.1.200).

### **Advanced Troubleshooting**

Try the following if you still are unable to connect:

- Use the ARP table to search for NVS-31 MARK IV’s MAC address; the MAC address can be found on the print label at the bottom of your device.
- MAC address is **00:07:36:04:85:64**.
- On the command prompt (terminal on MAC OS), enter "**arp -a**" then press enter key to display an ARP list. See if the NVS-31 MARK IV is successfully connected to the network.
- Execute **services.msc**, and on the right column of the “**Services**” window, locate “**DHCP Client**” then click “**Restart**”.
- On the command prompt, enter **ipconfig/flushdns** followed by **ipconfig/release** or **ipconfig/renew**.

## **6.2 Web User Interface**

By now, we have obtained the IP address of the NVS-31 MARK IV. Enter the NVS-31 MARK IV’s IP address into the address bar of a browser then hit the **ENTER** button. Login by entering the user name as well as the password into a pop-up dialogue box as shown below.



**Username: admin**

**Password: 000000**

Click the **Sign in** button to log in. Once logged in, the first page that appears will be the **Source** page.

## Source

You will see the **Source** page immediately after logging in to the NVS-31 MARK IV web UI. On the Source page, you will see **Input Information, Video Source, Audio Source, Resolution, Frame Rate, Channels, Bits Per Sample** and **Sample Frequency**.

Input Information	Video Source	Audio Source	Resolution	Frame Rate	Channels	Bits Per Sample	Sample Frequency
Channel 1	HDMI	Embed	1920x1080p	59.94	2	16	48000

**Note: The NVS-31 MARK IV web UI does not update automatically so to learn the latest device status, please refresh the page manually.**

While monitoring streaming and recording, please update the page periodically regardless of how you operate the device (using the device's physical buttons only or using the device's physical buttons along with the web UI). This ensures the page is always displaying the most up-to-date information.

## Operation Mode

Click the **Operation Mode** tab on the tool bar to open the operation mode configuration page on which the user will be allowed to customize various stream and record settings.

The NVS-31 MARK IV offers the following operation modes:

- **Stream**
- **Record**

which will be discussed in detail in this section.



## Stream Mode

The NVS-31 MARK IV has two stream engines allowing you to stream to two different destinations over multiple protocols. The configurable stream settings are **Encoder Source**, **Stream Type**, **Resolution**, **Frame Rate**, **Profile**, **Entropy**, **GOP**, **Encoder Mode**, **Video Bitrate (bps)** and **Audio Bitrate (bps)** which will be described later in this section.

The screenshot displays the 'Stream Mode' configuration interface for the NVS-31 MARK IV. The interface is organized into two columns, 'Streaming one' and 'Streaming two', each with a set of configuration options. The 'Encoder Source' is set to 'Enable' for both streams. The 'Stream Type' is 'RTSP'. Resolution is '1920 x 1080' and Frame Rate is '59.94'. Profile is 'Main', Entropy is 'CABAC', and GOP is '30'. Encoder Mode is 'Medium', Video Bitrate is '4 M', and Audio Bitrate is '384 K'. RTSP Port is '555' and RTSP HTTP Port is '8555'. Account is 'root' and Password is 'root'. Session Name is 'session0.mpg'. At the bottom of each column are buttons for 'Apply', 'Default', and 'Start Stream'. The top right corner shows system information: 'English', 'CPU : 2%', and 'Version : 2.1.6'.

Seven streaming protocols available on the NVS-31 MARK IV are **RTSP**, **RTMP**, **TS**, **HLS**, **SRT**, **KUAISHOU** and **DV Cloud**. See [Section 6.3](#) for instructions on each individual stream setup.

Note that once your video streams are set up, click **“Apply”** button to apply the new stream settings. Click **“Start Stream”** to open the stream and **“Stop Stream”** to end the stream. To reset, simply click the default button.

Next, we will discuss the stream setting options in greater detail.

### Encoder Source

This option allows you to enable the stream encoder for configurations of various parameters. If the stream encoder is not needed, disable this option.

## Stream Type

The NVS-31 MARK IV offers the user seven stream types which are **RTSP**, **RTMP**, **TS**, **HLS**, **SRT**, **KUAISHOU** and **DV Cloud**. Parameters of each individual protocol will be briefly described below.

### RTSP (Real Time Streaming Protocol)

- RTSP Port: The RTSP port number ranges from 554 to 562 and is 554 by default.
- RTSP HTTP Port: The RTSP HTTP port number ranges from 8553 to 8563 and is 8554 by default.
- Account / Password: The RTSP streaming account credentials which are root/root by default.
- Session Name: The default RTSP session name is session0.mgp.

See [RTSP/TS/HLS](#) for details.

### RTMP (Real-Time Messaging Protocol)

- RTMP URL: Enter an RTMP URL obtained from any live streaming platform such as Ustream.  
**Note: The NVS-31 MARK IV supports RTMP Publish only and not RTMP Local.**
- Stream Name: Enter a stream name or key from any live streaming platform such as Ustream.
- Account / Password: Enter the account name and the password of your RTMP platform account.

See [RTMP](#) for details.

### TS (Transport Stream)

- TS URL: Enter a URL for your transport stream.

See [RTSP/TS/HLS](#) for details.

### SRT (Secure Reliable Transport)

- Stream Type: Set the device as the caller or listener.
- SRT Port: Enter the port number designated for SRT traffic.
- Caller IP Address: Enter the IP address of the destined device.
- Latency (20 – 8000): Enter the amount of latency in ms to apply to the SRT stream. This field is optional and the default latency is 1000 ms.

See [SRT](#) for details.

### Kuaishou

This is specific for a streaming platform in China.

Please note that when streaming, the NVS-31 MARK IV converts video into data, which are sent across an IP network. High bitrates consume more bandwidth across the IP network. In a gigabit office LAN, high bitrate may not be a concern and Speed/Bandwidth is therefore not a limitation in an NVS-31 MARK IV application environment.

If your available bandwidth is limited, you should reduce both your resolution and your bitrate accordingly. A good rule of thumb is for the bitrate of your stream to use no more than 50% of your available upload bandwidth capacity on a dedicated line. For example, if the result you get from a speed test shows that you have 2Mbps of upload speed available, your combined audio and video bitrate should not exceed 1Mbps.

### Resolution

The first step of encoder setup is to adjust the image size. It is best to either match your original video source or scale it down. For example, capture at HD 720 and stream at HD 720. Or capture at HD 720 and stream at 540 (high).

You should never be scaling up and streaming at a higher resolution than your original video source. For example, it does not make sense to capture at 720 and stream at 1080. Note that you will also have no gain in quality and you are using more bandwidth than is necessary for your viewers.

You should also be aware that higher resolutions require greater processing power to encode the stream. Attempting too high of a resolution on too little processing power can result in degraded image quality and corrupted or interrupted streams or recordings.

Resolutions available for your stream encoder are listed as follows:

- 1080x1920
- 720x1280
- 576x720
- 480x720
- 480x640
- 240x320

### Frame Rate

Select a frame rate from the drop-down menu for video streaming. Note that frame rates should always match the frame rate of the video source.

- 60.00
- 59.94
- 50.00
- 30.00
- 29.97
- 25.00
- 20.00
- 15.00

### Profile

**Profile** sets the H.264 encoding profile for your stream. The available options are **Baseline**, **Main**, and **High**. Typically, **High** profile provides the best image quality and is suitable in most instances. However, depending on the decoder used when viewing the stream, such as with mobile devices, a Main or Baseline profile may be required.

- High

- Main
- Baseline

## Entropy

There are two coding options available for generating H.264 content:

- CAVLC (Context-Adaptive Variable Length Coding)
- CABAC (Context-based Adaptive Binary Arithmetic Coding)

CABAC encoding provides a 7-10% quality improvement over CAVLC but requires an extra 10-15% CPU. CABAC encoding is only available in H.264 Profiles Main & High. When targeting at low-powered devices, such as older cell phones and tablets, we recommend the Baseline Profile that uses CAVLC which requires less computing power.

## GOP

GOP pattern with longer GOP length encodes video very efficiently. Shorter GOP lengths usually work better with video that has quick movements, but they do not compress the data rate as much.

Depending on your applications, you can select 16 GOP sizes ranging from 1 to 255.

- 255
- 240
- 200
- 120
- 100
- 60
- 50
- 30
- 25
- 20
- 15
- 10
- 5
- 3
- 2
- 1

## Encoder Mode

The Encoder Mode sets the video bitrate mode for your video stream. The available modes are listed as follows:

- High (8M)
- Medium (4M)
- Low (2M)

**Tip:** You can also switch between different bitrate modes by pressing the **BITRATE** button in the **H.264 Encoder** button group. See [Section 6.4](#) for details.

### **Video Bitrate (bps)**

The bitrate of the video specifies the amount of information stored in the video. The higher the bitrate is, the clearer the video is. However, when choosing your encoder settings for streaming, you should first check your available upload bandwidth. A good rule of thumb is for the bitrate of your stream to use no more than 50% of your available upload bandwidth capacity on a **DEDICATED** line. For example, if the result you get from a speed test shows that you have 2Mbps of upload speed available, your combined audio and video bitrate should not exceed 1Mbps.

Usually high bitrate means good image quality; however, there are also exceptions. For example, SD video may appear acceptable at 1000 Kbps (1M) but HD video is unacceptable at 1000 Kbps.

Available video bitrates are listed as follows:

- 10M
- 8M
- 6M
- 4M
- 2M
- 1M
- 512K
- 256K

### **Audio Bitrate (bps)**

The NVS-31 MARK IV offers the user the following audio bitrates at which you may want to stream the audio. It is recommended to select 128Kbps or higher.

- 384 K
- 256 K
- 128 K
- 64 K
- 32 K

### ***Record Mode***

The NVS-31 MARK IV's record engine allows you to record your program on the SD card. See [Appendix 4](#) for a list of recommended SD cards. The record parameters shown in the diagram below will be discussed in detail in this section.

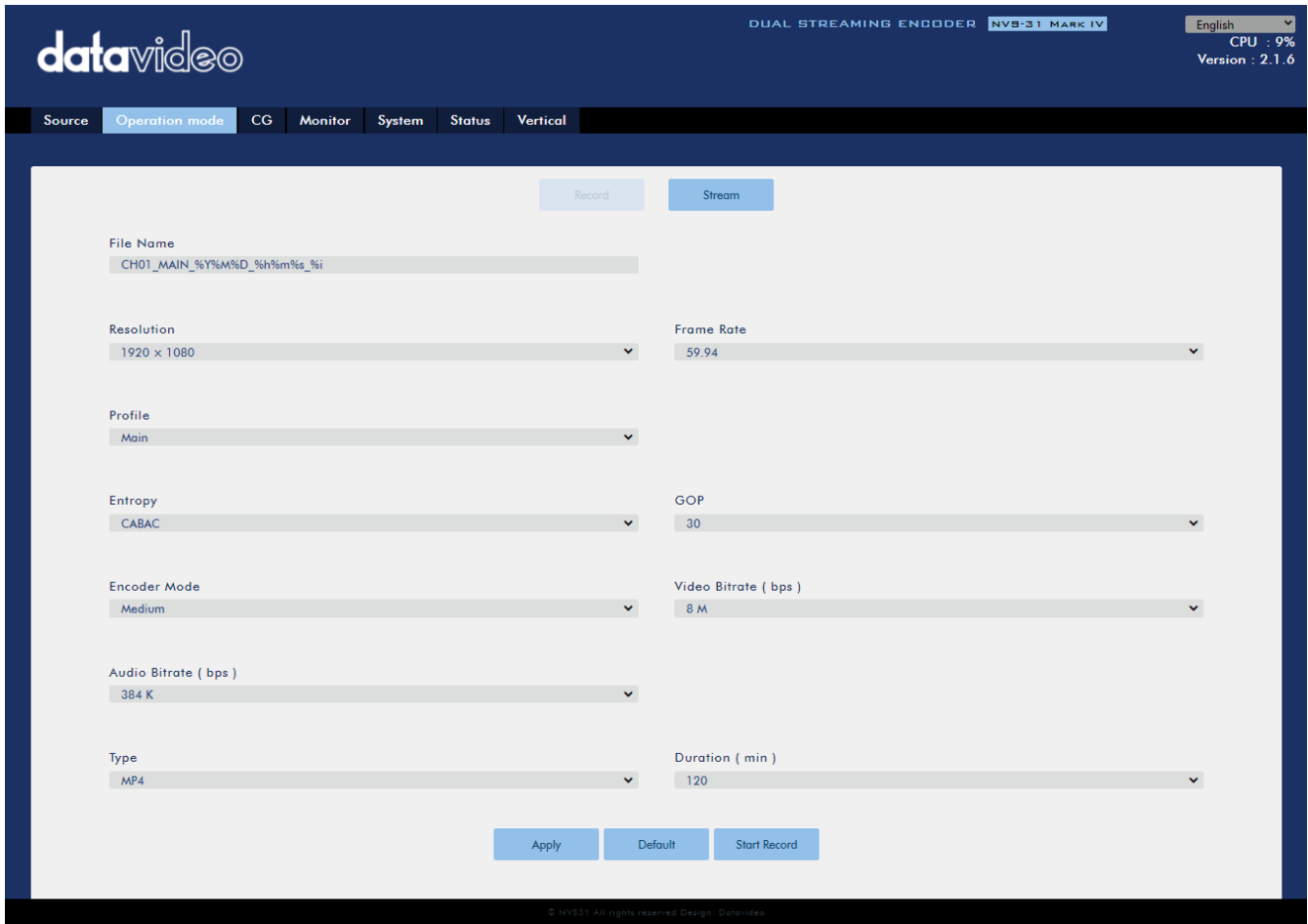

Note that after you've configured the record settings, click **“Apply”** to apply the new record settings. Click **“Start Record”** to start recording and **“Stop Record”** to end recording. To reset, simply click the default button.

### File Name

Enter the name of your record file.

### Resolution

Recording resolution is the number of pixels (dots) used to create an image. Higher resolutions use more pixels to create an image. This means that greater amounts of detail can be expressed in the image, but larger files sizes and a greater amount of storage (i.e. hard drive space) are required to save the images or video.

Resolutions available for your recorder are listed as follows:

- 1080x1920
- 720x1280
- 576x720
- 480x720
- 480x640
- 240x320

### Frame Rate

Select a frame rate from the drop-down menu for video recording.

- 60.00
- 50.00
- 30.00
- 29.97
- 25.00
- 20.00
- 15.00

Frame rate greatly impacts the style and viewing experience of a video. Different frame rates yield different viewing experiences, and choosing a frame rate often means choosing between things such as how realistic you want your video to look, or whether or not you plan to use techniques such as slow motion or motion blur effects.

Below is a list of common options for different applications:

- **24fps** – This is the standard for movies and TV shows, and it was determined to be the minimum speed needed to capture video while still maintaining realistic motion.
- **30fps** – Videos with a lot of motion, such as sports, will often benefit from the extra frames per second.
- **60+fps** – Anything higher than 30fps is mainly used to create slow motion video or to record video game footage.

### Profile

**Profile** sets the H.264 encoding profile for your recorder. The available options are **Baseline**, **Main**, and **High**. Typically, **High** profile provides the best image quality and is suitable in most instances. However, depending on the decoder used when viewing the recording, a Main or Baseline profile may be required.

- High
- Main
- Baseline

### Entropy

There are two coding options available for generating H.264 content:

- CAVLC (Context-Adaptive Variable Length Coding)
- CABAC (Context-based Adaptive Binary Arithmetic Coding)

CABAC encoding provides a 7-10% quality improvement over CAVLC but requires an extra 10-15% CPU. CABAC encoding is only available in H.264 Profiles Main & High. When targeting at low-powered devices, such as older cell phones and tablets, we recommend the Baseline Profile that uses CAVLC which requires less computing power.

### GOP

GOP pattern with longer GOP length encodes video very efficiently. Shorter GOP lengths usually work better with video that has quick movements, but they do not compress the data rate as much. Depending on your applications, you can select 16 GOP sizes ranging from 1 to 255.

- 255
- 240
- 200
- 120
- 100
- 60
- 50
- 30
- 25
- 20
- 15
- 10
- 5
- 3
- 2
- 1

### Encoder Mode

The Encoder Mode sets the video bitrate mode for your recording. The available modes are listed as follows:

- High (8M)
- Medium (4M)
- Low (2M)

**Tip: You can also switch between different bitrate modes by pressing the BITRATE button in the H.264 Encoder button group. See [Section 6.4](#) for details.**

### Video Bitrate (bps)

The bitrate of the video specifies the amount of information stored in the video. The higher the bitrate is, the clearer the video is.

Available video bitrates are listed as follows:

- 16M
- 12M
- 8M
- 6M
- 4M
- 2M
- 1M
- 512K
- 256K

Recommended video bitrates

- **720P or lower** – 8 – 10 mbps



- **1080P or higher** – 15 mbps or higher

### Audio Bitrate (bps)

The NVS-31 MARK IV offers the user the following audio bitrates at which you may want to record the audio. It is recommended to select 128Kbps or higher.

- 384 K
- 256 K
- 128 K
- 64 K
- 32 K

### Type

Select the record file format from the list below:

- MP4
- TS

### Duration (min)

Select the length of the record file from the list below:

- Unlimitation (No file limit)
- 120
- 60
- 30
- 5
- 1

### CG

The CG function allows the user to place multiple texts, scrolling texts (News), a picture (Graphic), a logo and an animated image above the video layer. Various CG layers will be discussed in this section.

#### Text

You are allowed to insert up to 30 text objects in your video in a customized order. First enter the text that you want to place on the video in the **Text** field then customize the following text properties.

The screenshot shows a user interface for customizing text. It features several input fields and dropdown menus:

- Text:** A text input field.
- Size:** A dropdown menu with 'Large' selected.
- Font:** A dropdown menu with 'NotoSerifCJKtc' selected.
- Text Color:** A dropdown menu with 'Black' selected.
- Border Line:** A dropdown menu with 'Off' selected.
- Border Color:** A dropdown menu with 'Black' selected.
- Effect:** A dropdown menu with 'Cut in' selected.

**Size:** Set the font size to large, medium or small.

**Font:** NotoSerifCJKtc and Open are the two available font types.

**Text Color:** You can set the text color to Black, Blue, Green, Orange, Red, White or Yellow.

**Border Line:** Select ON to enable the border line of the text entered.

**Border Color:** The border line color can be set to Black, White or Yellow.

**Effect:** This sets how the text enters the video. Select “**Cut in**” if you want the text to appear with no effect. If you want the text to enter from either side of the screen, select “**Left to Right**” or “**Right to Left**”.

**Location:** Set the coordinates of the text object. The position of the text on the screen will be shown in the location box and previewed on the Monitor connected to the CG-Preview port or HDMI OUT 4.

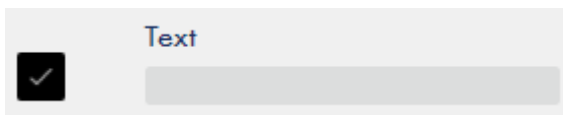

Lastly, set the order in which each individual text should appear on the video by checking the box next to the Text field on the left.

Text

News

Graphic

Logo

Animation

Select All Inedx



1



Text  Size **Large** Font **NotoSerifCJKIt**

Text Color **Black** Border Line **Off** Border Color **Black** Effect **Cut in**

2



Text  Size **Large** Font **NotoSerifCJKIt**

Text Color **Black** Border Line **Off** Border Color **Black** Effect **Cut in**

3



Text  Size **Large** Font **NotoSerifCJKIt**

Text Color **Black** Border Line **Off** Border Color **Black** Effect **Cut in**

28



Text  Size **Large** Font **NotoSerifCJKIt**

Text Color **Black** Border Line **Off** Border Color **Black** Effect **Cut in**

29



Text  Size **Large** Font **NotoSerifCJKIt**

Text Color **Black** Border Line **Off** Border Color **Black** Effect **Cut in**

30



Text  Size **Large** Font **NotoSerifCJKIt**

Text Color **Black** Border Line **Off** Border Color **Black** Effect **Cut in**

Location ( For reference only )

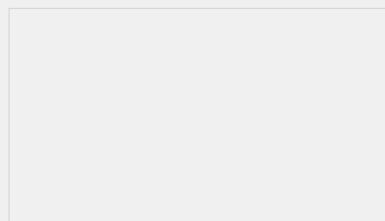

Y  
▲  
0  
▼

X  
◀ 0 ▶

Auto

Start Playloop

Stop Playloop

Start Playlist

Stop Playlist

Start Preview

Stop Preview

Start CG

Stop CG

After you've entered and configured the texts, and set the order in which they should appear, you may enable them on the video using one of the four ways described below:

Click **“Start Playloop”** to repeat the playlist.

Click **“Start Playlist”** to play the list once.

Click **“Start Preview”** to preview how the texts will appear on the video.

Click **“Start CG”** to show all texts at once.

### **News**

News allows you to enter the text in multiple lines and put the scrolling text in the video. First enter the content of the scrolling text in the text box then customize the following text properties.

**Size:** Set the font size to large, medium or small.

**Font:** NotoSerifCJKtc and Open are the two available font types.

**Text Color:** You can set the text color to Black, Blue, Green, Orange, Red, White or Yellow.

**Border Line:** Select ON to enable the border line of the text entered.

**Border Color:** The border line color can be set to Black, White or Yellow.

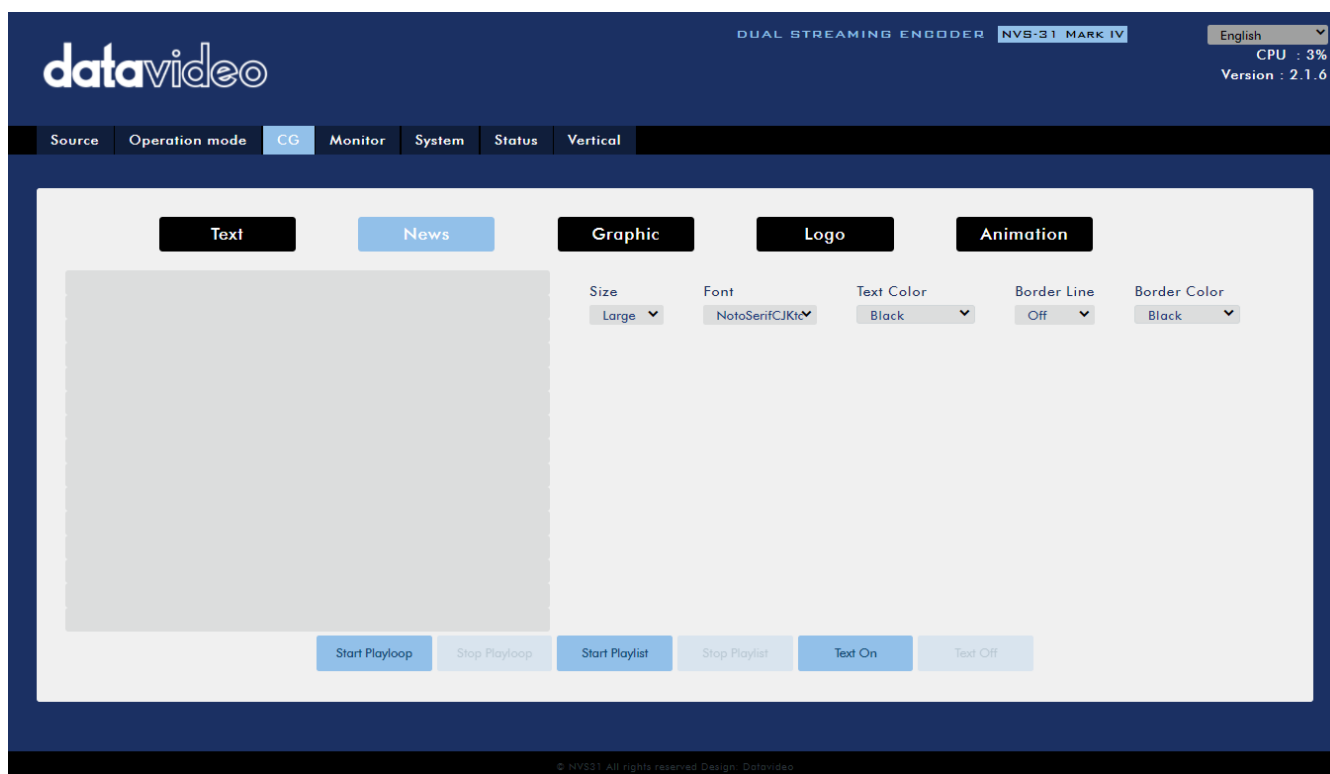

After you’ve entered and configured the scrolling text, you may enable them on the video using one of the three ways described below:

Click **“Start Playloop”** to repeat the scrolling text.

Click **“Start Playlist”** to play the scrolling text once.

Click **“Text On”** to show the scrolling text at once.

**Please note that the news text can be previewed on the Monitor connected to the CG-Preview port or HDMI OUT 4.**

## Graphic

You can also add a picture to the video. You will be required to select a png file from your local hard disk. Click **Select** to browse the hard drive for your graphic file then click **Update** to start the upload.

After the graphic file has been successfully uploaded, you can adjust the size by entering appropriate values in the **Width** and **Height** fields.

The **Effect** drop-down list sets how the image enters the video. Select “**Cut in**” if you want the image to appear with no effect. If you want the image to enter from either side of the screen, select “**Left to Right**” or “**Right to Left**”.

Lastly, set the coordinates of the image. The position of the image on the screen will be shown in the location box and previewed on the Monitor connected to the CG-Preview port or HDMI OUT 4.

To turn on the graphic image, simply click the **ON** button which can be found at the bottom of the page.

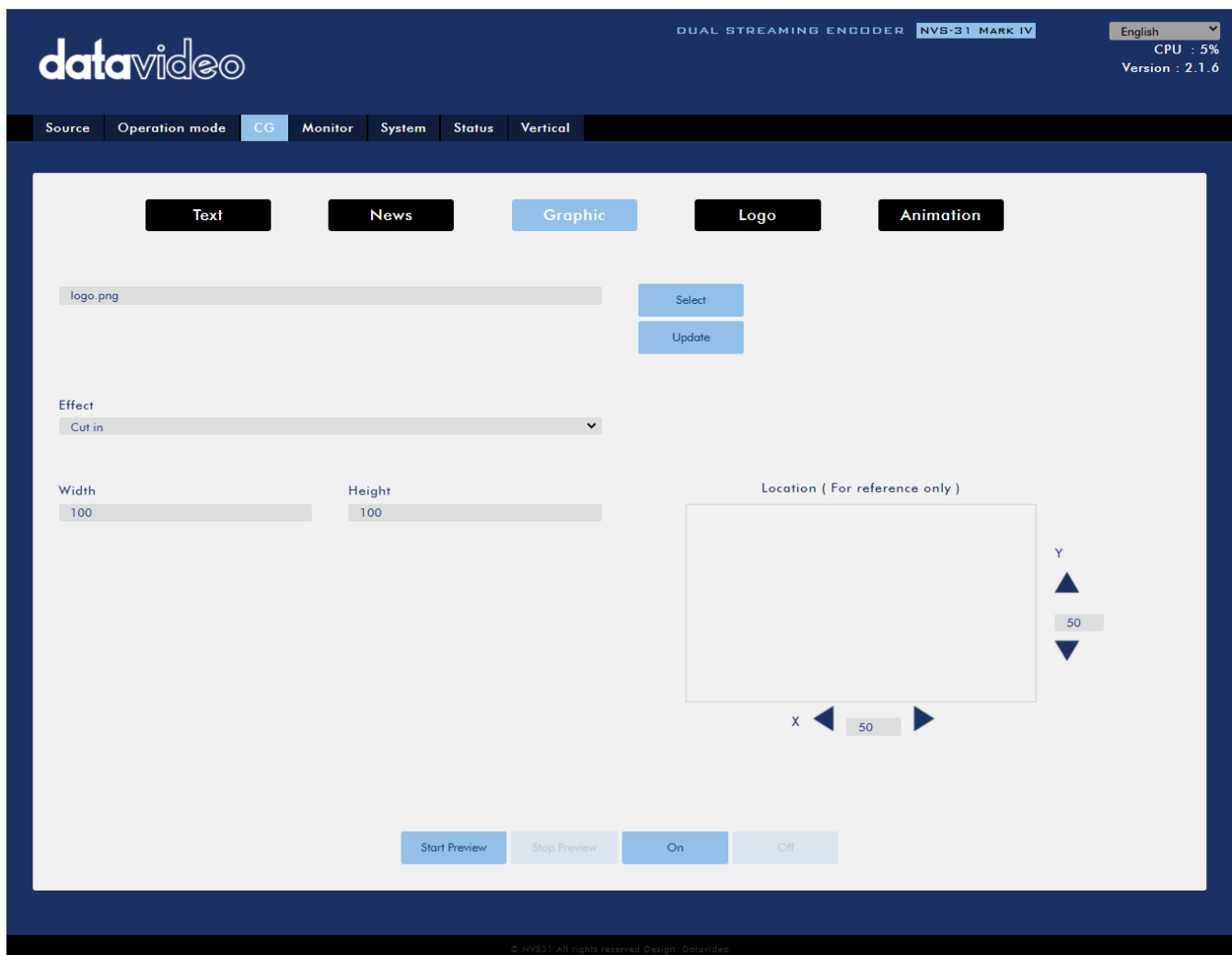

## Logo

You can also add a logo to the video. You will be required to select a jpg, jpeg, bmp, png or gif file from your local hard disk. Click **Select** to browse the hard drive for your logo file then click **Update** to start the upload.

After the logo file has been successfully uploaded, you can adjust the size by entering appropriate values in the **Width** and **Height** fields.

The **Effect** drop-down list sets how the logo enters the video. Select “**Cut in**” if you want the logo to appear with no effect. If you want the logo to enter from either side of the screen, select “**Left to Right**” or “**Right to Left**”.

Lastly, set the coordinates of the logo. The position of the logo on the screen will be shown in the location box and previewed on the Monitor connected to the CG-Preview port or HDMI OUT 4.

To enable the logo, simply click the **ON** button which can be found at the bottom of the page.

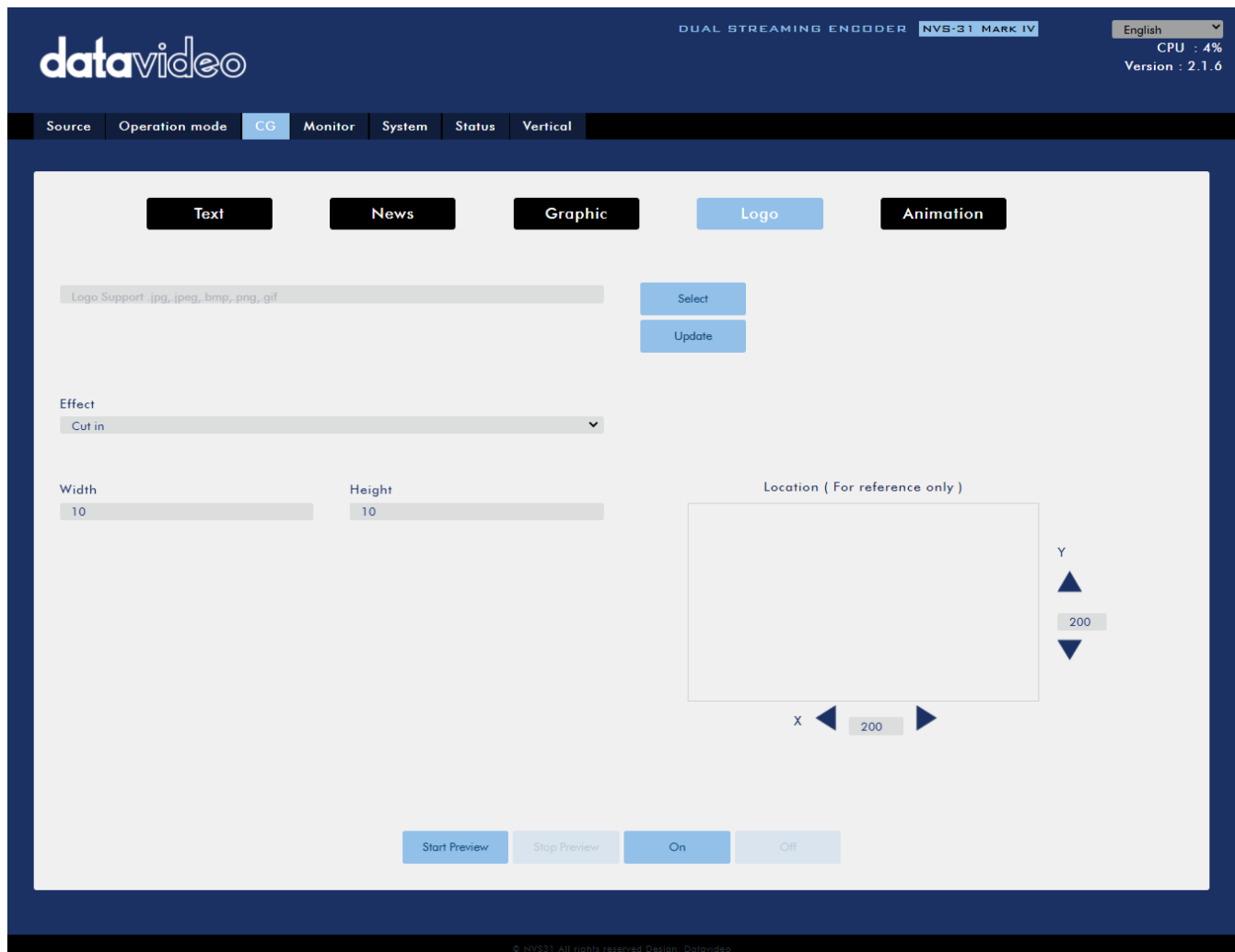

### **Animation**

You can also add an animation to the video. You will be required to select a jpg, jpeg, bmp, png or gif file from your local hard disk. Click **Select** to browse the hard drive for your animation file then click **Update** to start the upload.

After the animation file has been successfully uploaded, you can adjust the size by entering appropriate values in the **Width** and **Height** fields.

The **Effect** drop-down list sets how the animation enters the video. Select “**Cut in**” if you want the animation to appear with no effect. If you want the animation to enter from either side of the screen, select “**Left to Right**” or “**Right to Left**”.

Lastly, set the coordinates of the animation. The position of the animation on the screen will be shown in the location box and previewed on the Monitor connected to the CG-Preview port or HDMI OUT 4.

To enable the animation, simply click the **ON** button which can be found at the bottom of the page.

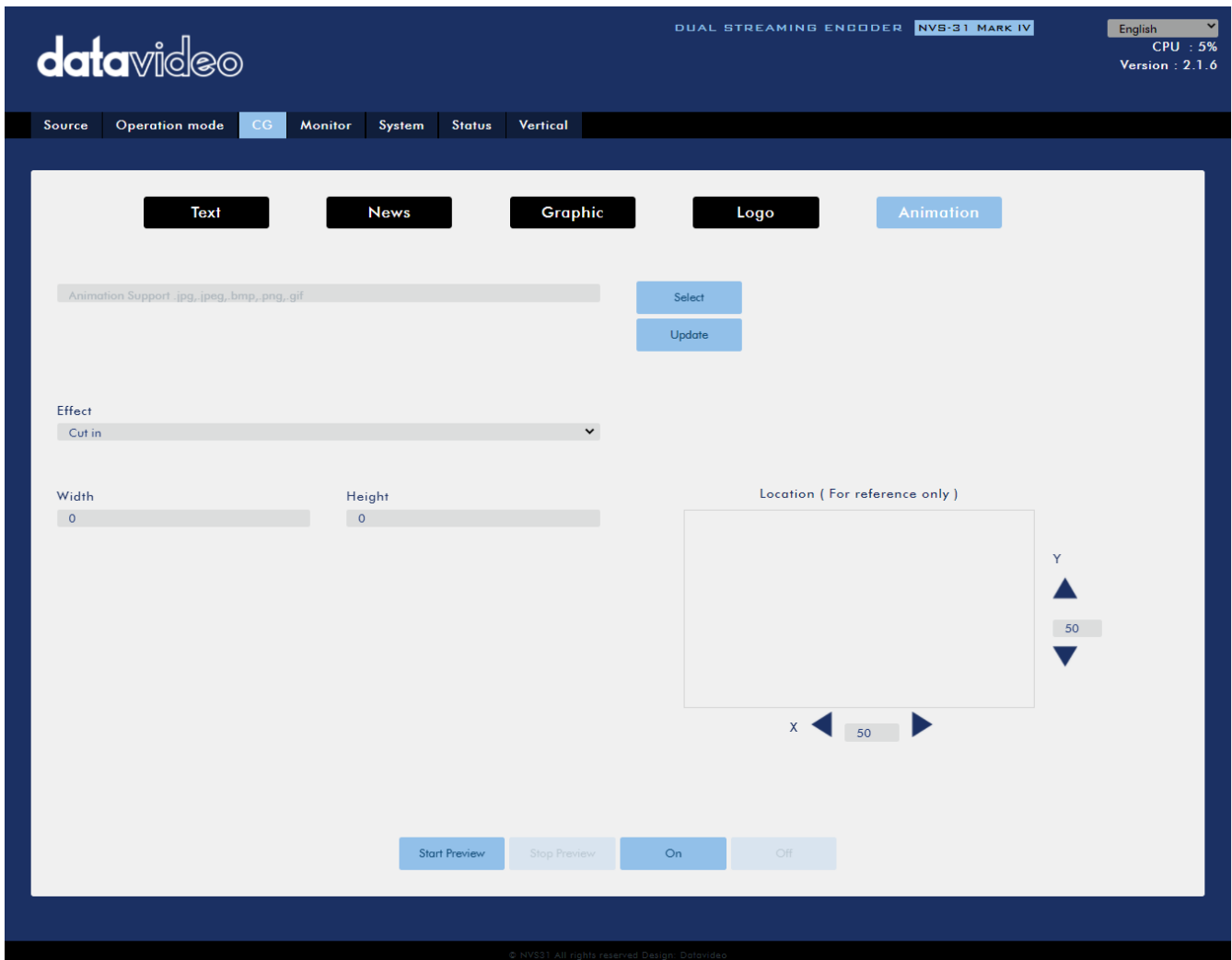

## Monitor

This sets the frame rate of the HDMI outputs. You can also adjust the audio delay.

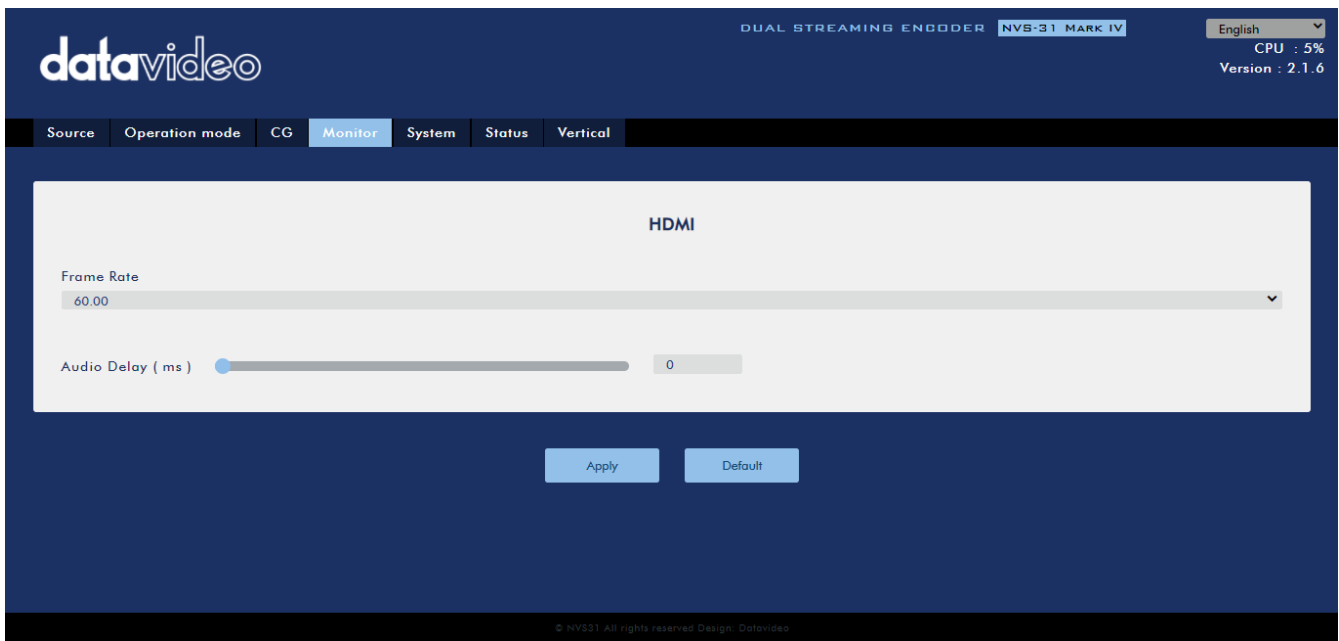

## System

The system page allows the user to configure several network and system related settings.

The network settings are **DHCP enable/disable**, **static IP address**, **subnet mask**, **default gateway**, **primary and secondary DNS**, and etc.

The system settings are **account credentials**, **time setting**, **firmware update**, **disk format**, **device name** and **timeout period**.

The system page is shown in the diagram below.



### Network Setting

DHCP	Static IP
Enable	192.168.1.200
Subnet Mask	Default Gateway
255.255.255.0	192.168.1.1
Primary DNS	Secondary DNS
192.168.1.100	0.0.0.0

Apply Default

### Account and Password

New Account	New Password	Apply
-------------	--------------	-------

### Time Setting

Type	Timezone	Apply
Automatically from the internet	UTC+8	
NTP Server		
time.google.com		

### Firmware Update

File Path	Browse
	Update

### Disk Information

Device	Apply
Device0:	
Format Type	Format
FAT-32	

### Device Name Setting

Device Name	Apply
-------------	-------

### Other Option

Timeout Period	Apply
20 Min	

### System Control

Restore to Default Reboot

## ***Network Setting***

In network settings, you can either manually enter the IP address or set the device to DHCP mode which allows the router to automatically assign the IP address to the NVS-31 MARK IV.

### **DHCP**

In DHCP mode, the router automatically assigns the IP address to the device. If you want to manually configure the network settings, disable this option.

### **Static IP Address**

If the DHCP is disabled, the static IP field will be activated for the user to manually enter the IP address. The static IP address is 192.168.1.200 by default.

**Tip: If you do not know the device's IP address, you can always use the following method to reset the network settings.**

- Shut down the machine
- Turn on the machine while holding down **RECORD** and **STREAM** buttons simultaneously.
- Approximately after 5 seconds, release the **RECORD** and **STREAM** buttons as soon as the button LEDs are turned **ON**.
- The default IP address should be 192.168.1.200.

### **Subnet Mask**

Static IP address mode requires the **subnet mask**, which is 255.255.255.0 by default.

### **Default Gateway**

Static IP address mode requires the **default gateway**, which is 192.168.1.254 by default.

### **Primary DNS (Optional)**

Primary DNS is required in static IP mode only but is optional.

### **Secondary DNS (Optional)**

Secondary DNS is required in static IP mode only but is optional.

### ***Account and Password***

Set the Web UI's login account name and password here. Click **Apply** to save the new login credentials.

### ***Time Setting***

In time setting, you are allowed to select the reference time source for the NVS-31 MARK IV.

### **Type**

In this drop-down menu, you can either select to allow the device to retrieve the time automatically from the Network Time Protocol (NTP) server by selecting "**Automatically from the Internet**" or locally by selecting "**Manual**".

### ***NTP Server***

If you've selected "**Automatically from the Internet**," you will need to enter the NTP server address here. An example of the NTP server address is time.google.com.

### **Manual**

If you've selected "**Manual**", the **Date** and **Time** fields will appear showing the device's system date and time values. A calendar will appear after the **Date** field is clicked. Simply click a day to set the date. Set the time in the **Time** field.

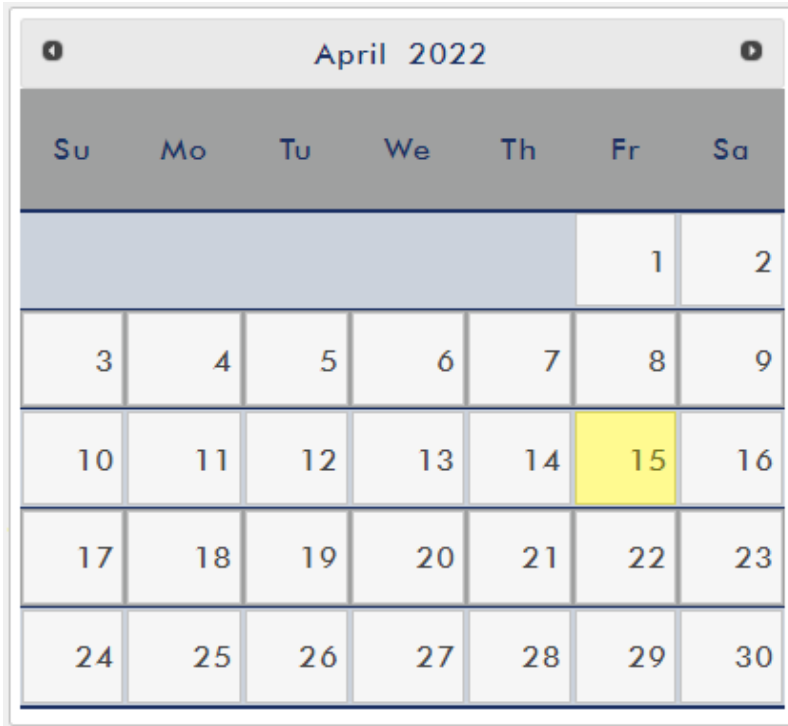

### **Time Zone**

Click the drop-down menu to select a time zone for your device.

After you've configured the time settings, click **Apply** to save the new settings.

### **Firmware Update**

Click **Browse** to search for the latest firmware file saved on the PC's hard disk. After the latest firmware file is uploaded, click **Update** to start the firmware update.

### **Disk Format**

In this pane, you will be allowed to view the SD card information and format the SD card to one of the format types listed as follows:

- FAT-32
- NTFS
- EXFAT

Click **Format** to start formatting.

### **Device Name Setting**

Enter a name for this device and click **Apply** to save the name.

### **Other Option**

#### **Timeout Period**

This sets the timeout period for the current login. See below for available options.

- 20 Min
- 120 Min
- 1 Day
- 7 Day
- Never

### System Control

#### Restore to Default

Click to restore the system’s default settings.

#### System Reboot

Click to reboot the NVS-31 MARK IV.

### Status

The status page shows **Record**, **Stream** and **Disk** information as depicted in the diagram below.

**Note: The NVS-31 MARK IV web UI does not update automatically so to learn the latest device status, please refresh the page manually.**

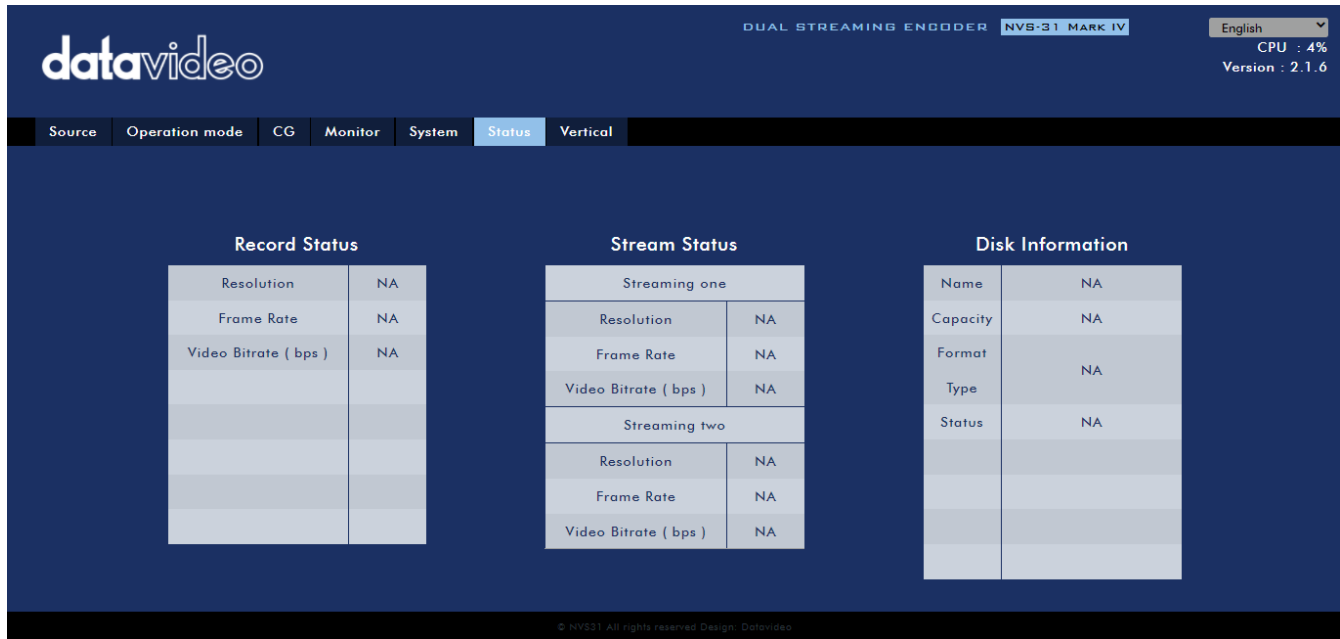

While monitoring streaming and recording, please update the page periodically regardless of how you operate the device (using the device’s physical buttons only or using the device’s physical buttons along with the web UI). This ensures the page is always displaying the most up-to-date information.

### Vertical

On this page, you will be able to change your stream video orientation.

- Crop: Designed for allowing 16:9 video output and left/right image crop.
- Rotate: Designed for video production; if the camera is placed upside down, this mode will reverse it.

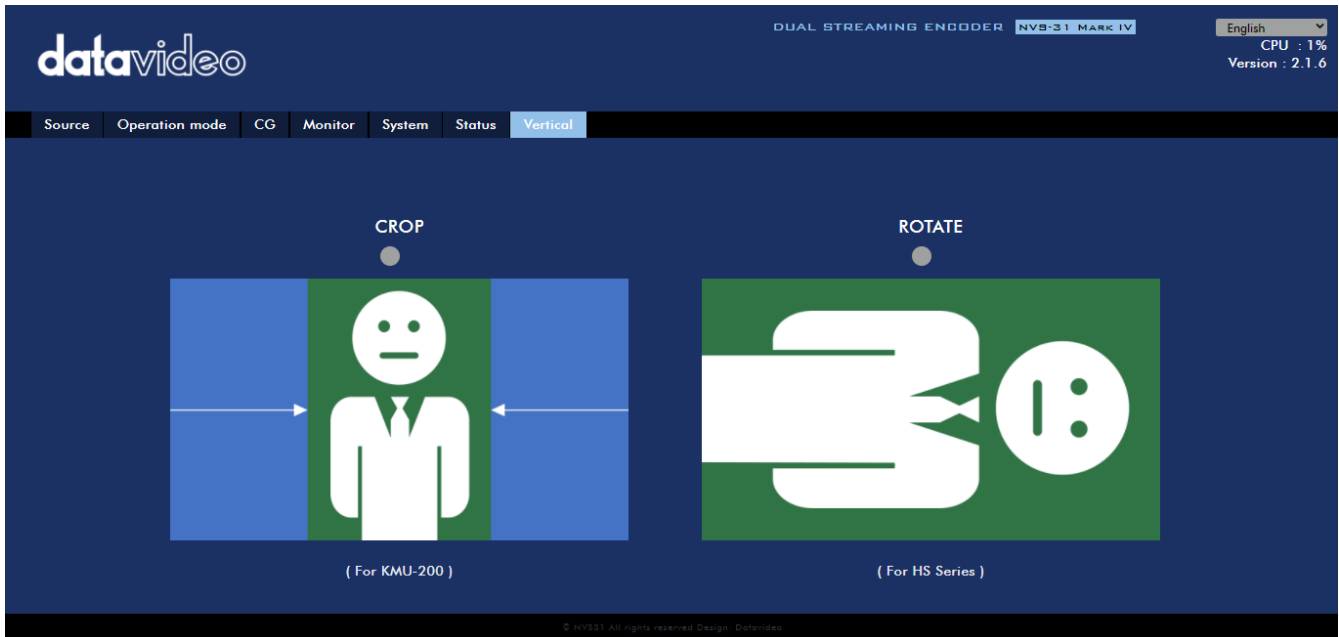

## 6.3 Operations

In this section, we will discuss how you can play the video using different streaming protocols.

### Video Streaming

The NVS-31 MARK IV provides the user with different video streaming options such as RTSP, TS, RTMP, and HLS.

This section discusses settings of these options and how to stream your video using these methods.

### RTSP/TS/HLS

In the **RTSP/TS/HLS** modes, the **NVS-31 MARK IV** is a stream server which allows any client device to connect and playback your video stream.



The following operation procedure uses VLC media player to playback video stream. If your PC or laptop does not have VLC media player installed, please visit VideoLAN's official homepage (<https://www.videolan.org/>) and download the installation file then install the program.

**Follow the steps below to obtain the RTSP URL:**

1. On the web UI, click **"Operation Mode"** → **"Stream"** to open the stream settings page.
2. Select **RTSP** from **Stream Type** drop-down menu.

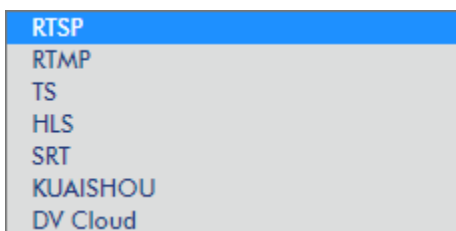

3. Click the **Start Stream** button to generate the RTSP URL.

Start Stream

- Based on your settings, the device will automatically generate the RTSP URL **rtsp://root:root@192.168.1.200:556/session0.mpg**.

Play URL

rtsp://root:root@192.168.1

- To view the RTSP video stream, enter the RTSP URL into the client device.
- Open VLC then click **Open Network Stream** (shown in the diagram below).

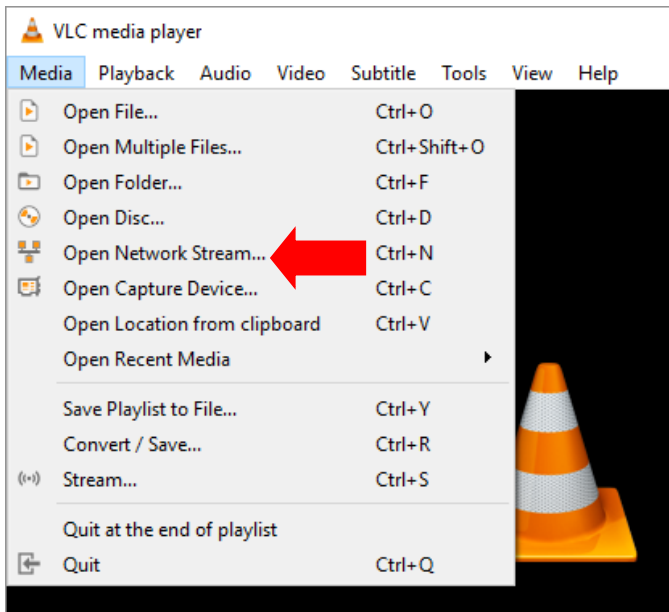

- As shown in the diagram below, enter the stream URL then click **Play** to start streaming.

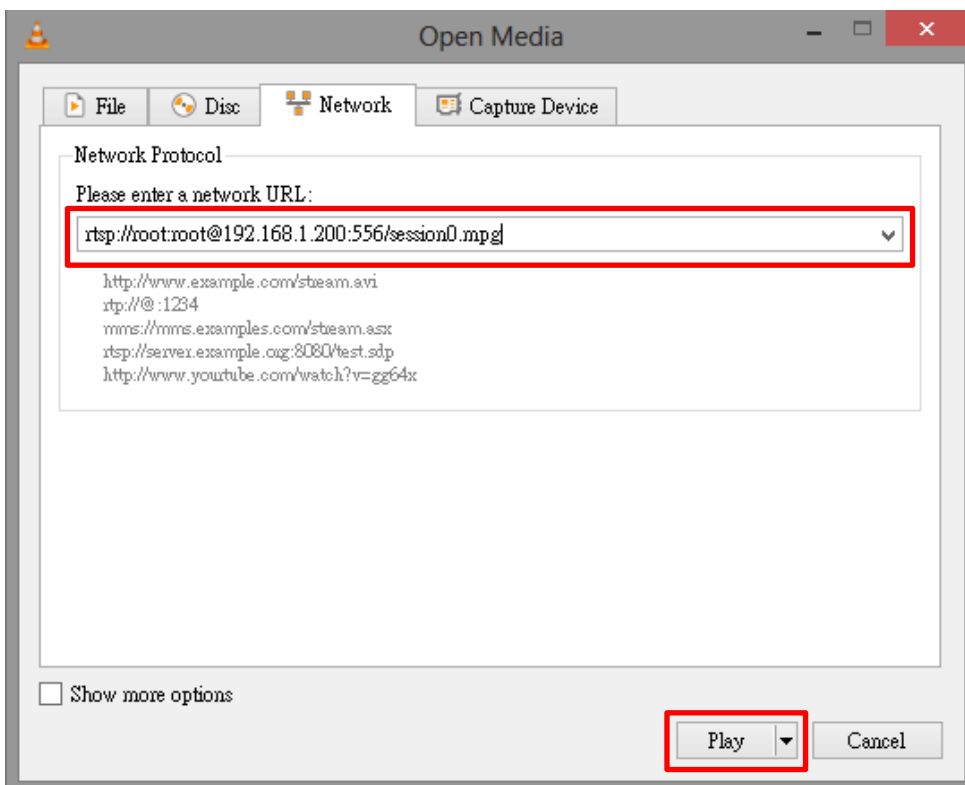

**Follow the steps below to obtain the TS URL:**

1. On the web UI, click “**Operation Mode**” → “**Stream**” to open the stream settings page.
2. Select **TS** from **Stream Type** drop-down menu.

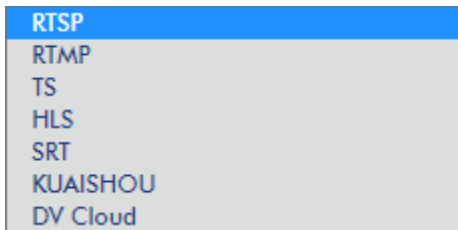

3. Enter the TS URL. Note that the TS URL shown below is only for illustration purpose.

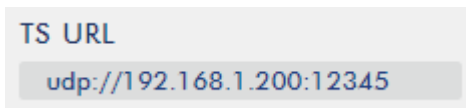

4. Click the **Start Stream** button to start the stream.

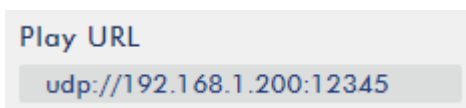

5. Enter the TS play URL into the client device to which the video stream is delivered over TS protocol.
6. On the computer, open VLC then click **Open Network Stream** (shown in the diagram below).

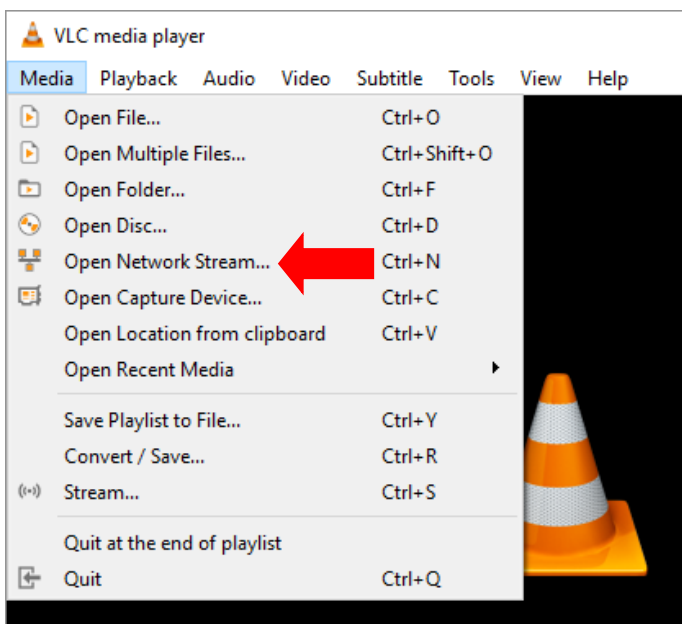

7. As shown in the diagram below, enter the stream URL then click **Play** to start streaming.

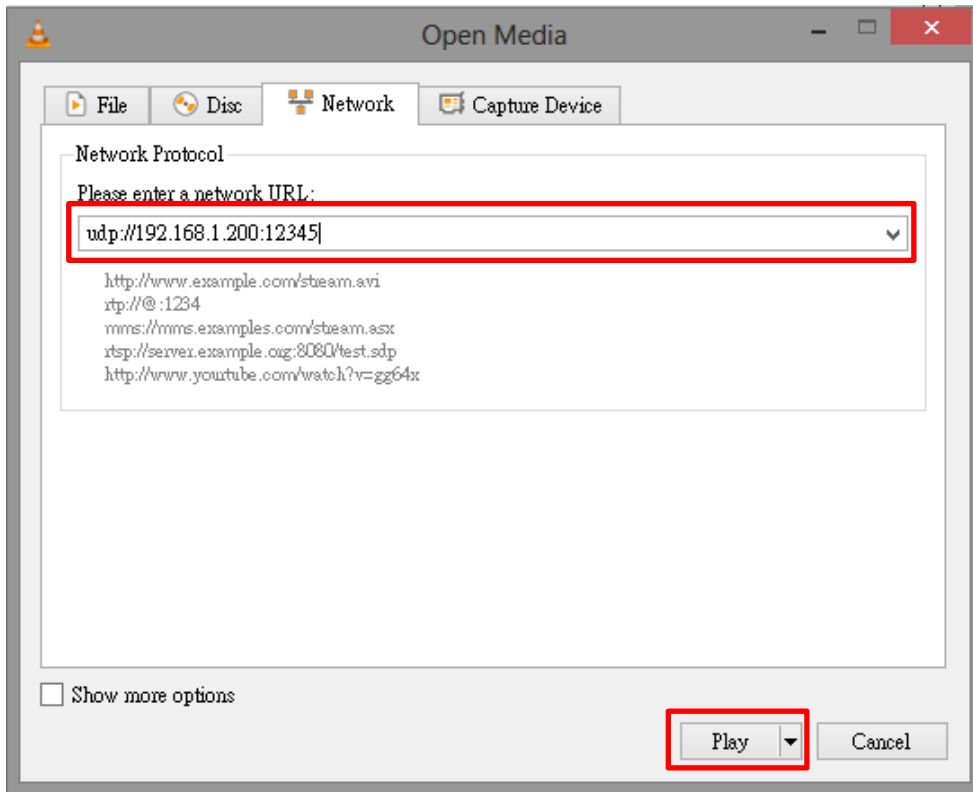

**Follow the steps below to obtain the HLS URL:**

1. On the web UI, click “**Operation Mode**” → “**Stream**” to open the stream settings page.
2. Select **HLS** from **Stream Type** drop-down menu.

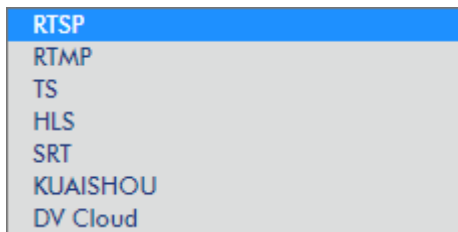

3. Click the **Start Stream** button to start the stream.



4. Based on your settings, the device will automatically generate a .m3u8 stream URL:  
http://192.168.1.200/hls/2/session0.m3u8
5. Enter the **HLS** URL into the client device.
6. Open VLC then click **Open Network Stream** (shown in the diagram below).



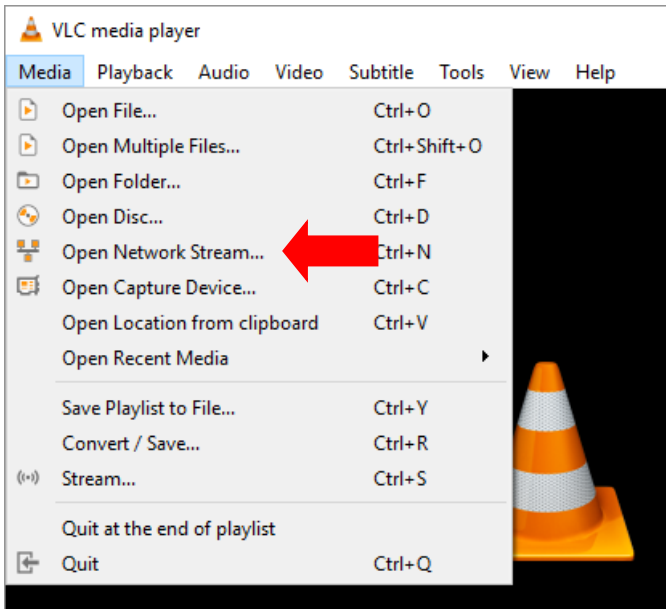

7. As shown in the diagram below, enter the stream URL then click **Play** to start streaming.

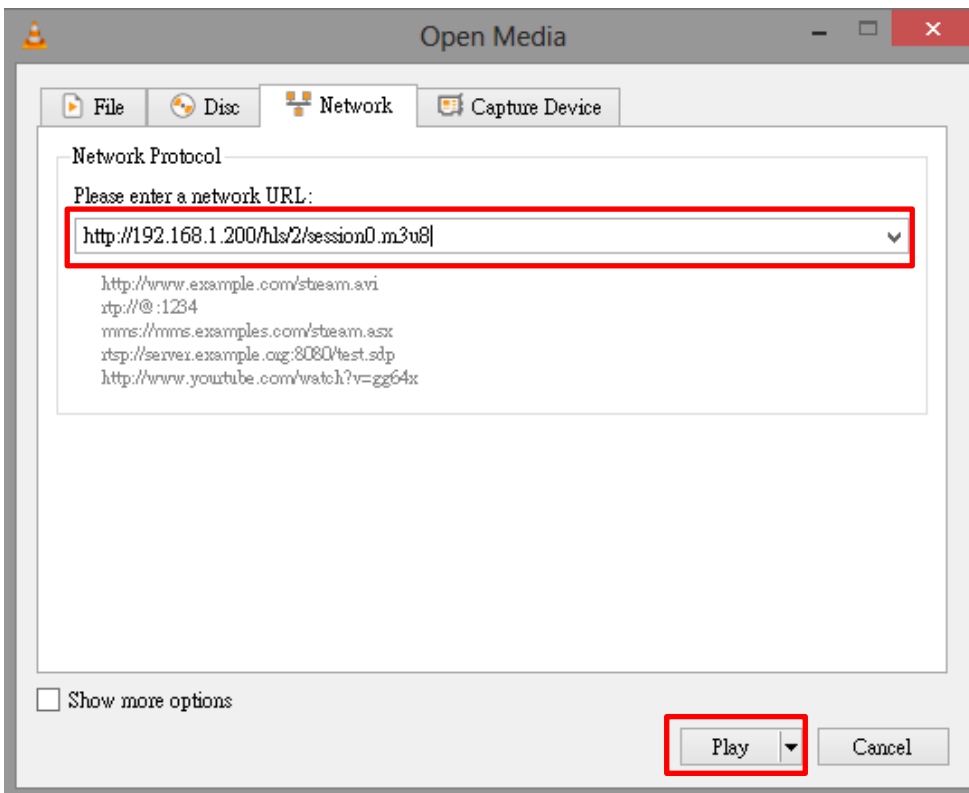

8. You can also play .m3u8 stream URL using the devices listed as follows:

- iPhone, iPad and MacBook: Use Safari to open the .m3u8 stream URL.
- Windows 10: Use Microsoft Edge to open the .m3u8 stream URL.

### **RTMP**

In the **RTMP** mode, the NVS-31 MARK IV can send up to two data streams to multiple CDNs or media servers that support the **Real-Time Messaging Protocol**. Examples of the **RTMP** media server are **USTREAM** and **Youtube**.

**Note: The NVS-31 MARK IV does not support RTMP local.**

In the following section, we will show you how to set up an **RTMP** stream to **Youtube**. The step-by-step account setup is outlined as follows:

1. First, obtain the Server URL and Stream name/key from Youtube.
2. Open the Youtube Live Dashboard [https://www.youtube.com/live\\_dashboard](https://www.youtube.com/live_dashboard)
3. On the left column, locate and click “**Stream now.**”

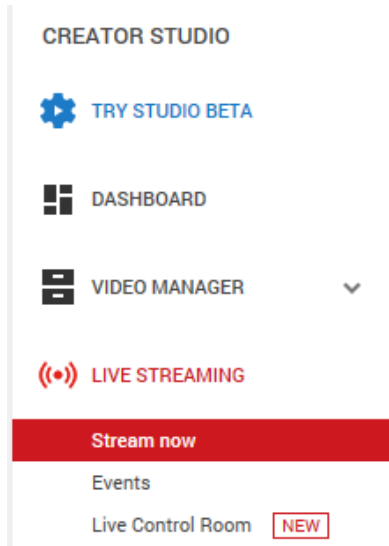

4. On the right, scroll down to the bottom where you will be able to find **Server URL** and **Stream name/key**.

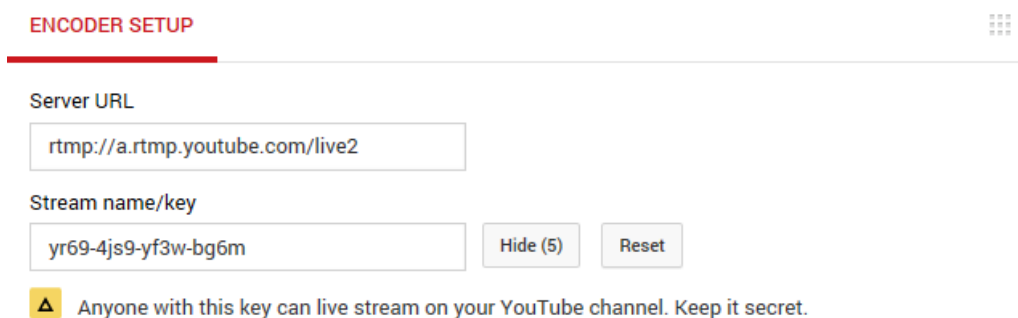

5. On the NVS-31 MARK IV, open the **Stream** operation mode page.
6. Select **RTMP** from the Stream Type drop-down menu.

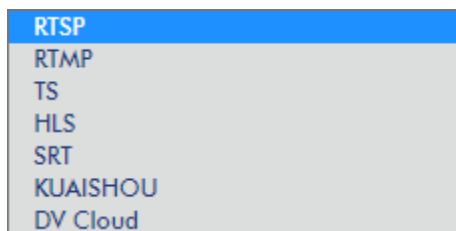

7. Enter the **Server URL (rtmp://a.rtmp.youtube.com/live2)** obtained from the **Youtube Live Streaming** page into the **RTMP URL** field.

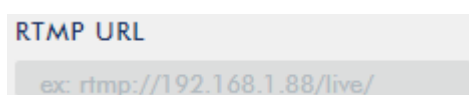

8. Enter the **Stream name/key (yr69-4js9-yf3w-bg6m)** obtained from the **Youtube Live Streaming** page into the **StreamName** field.

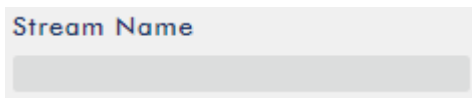

A screenshot of a web form showing a text input field labeled "Stream Name". The field is empty and has a light gray border.

9. As required by the live streaming channel, enter your Youtube account name and password into the **Account** and **Password** fields.



A screenshot of a web form showing two text input fields side-by-side. The left field is labeled "Account" and the right field is labeled "Password". Both fields are empty and have a light gray border.

10. Click the **Start Stream** button to start streaming the live video to the **Youtube Live**. You should also see an **RTMP URL** generated.

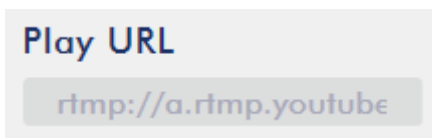

A screenshot of a web form showing a text input field labeled "Play URL". The field contains the text "rtmp://a.rtmp.youtube".

11. At this point, you should be able to view your stream video on Youtube.
12. To stop live streaming, simply click the **Stop Stream** button.

### **SRT**

When setting up an SRT stream on NVS-31 MARK IV, you can configure it as an SRT source encoder (caller mode) or an SRT destination decoder (listener mode).

To establish an SRT link between the source and destination devices, ensure that one device is a Listener and the other is a Caller. The device you set as the caller or listener is entirely arbitrary.

To access the device's SRT settings, log in to the web UI, select the **"Operation Mode"** tab, then click the **"Stream"** button to open the stream settings page.

**Now, follow the steps below to set up the SRT traffic:**

1. Select **SRT** from **Stream Type** drop-down menu.



A screenshot of a web form showing a dropdown menu labeled "Stream Type". The dropdown is open, and "SRT" is selected. A small downward arrow is visible to the right of the text.

2. Scroll down to the bottom and locate a second **Stream Type** drop-down menu in which you will be able to set the device to the Caller (source) or Listener (destination) mode.



A screenshot of a web form showing a dropdown menu labeled "Stream Type". The dropdown is open, and "Caller" is selected. A small downward arrow is visible to the right of the text.

- a. If Caller is selected, do the following:
  - In the **IP Address and SRT Port** fields, enter the IP address and the port number of the destination device (decoder) respectively. If your SRT stream destination is a CDN or media server, the IP address and the port number should be provided by the service provider.

- In the **Latency** field, enter the amount of latency to apply to the stream. The default value is 1000 ms.
- b. If Listener is selected, simply enter a port number that you intend to use on this device for the SRT stream.
3. Click the **Start Stream** button to start the SRT stream.

## 6.4 Record/Stream Panel

The **RECORD**, **STREAM**, **VERTICAL** and **BITRATE** buttons on the front panel of the SHOWCAST 100 give the user certain controls of the record and stream functions. In this section, we will cover operations of these four buttons in detail.



The table below summarizes the **RECORD** and **STREAM** Button LED behaviors:

	RECORD Button	STREAM Button
<b>Solid White</b>	Record function in idle state	Stream function in idle state
<b>Blinking Red</b>	Record function is activating or resetting	Stream function is activating or resetting
<b>Solid Red</b>	Record function activated	Stream function activated

### Record Button

Press the **RECORD** button to start/stop recording.

#### Start recording

- When idle, the **RECORD** button is solid white.
- Press and hold the **RECORD** button for approximately 2 seconds.
- When the record function is activating, the **RECORD** button turns from solid white, then blinking red and finally to solid red.
- When the **RECORD** button is solid red, this indicates that the record function has been successfully activated.

#### Stop recording

- While recording, the **RECORD** button is solid red.
- Press and hold the **RECORD** button for approximately 2 seconds.
- When the record function is terminating, the **RECORD** button turns from solid red, then blinking red and finally to solid white.
- When the **RECORD** button is solid white, this indicates that the record function has been successfully terminated.

## ***Stream Button***

Press the **STREAM** button to start/stop streaming.

### **Start streaming**

- When idle, the **STREAM** button is solid white.
- Press and hold the **STREAM** button for approximately 2 seconds.
- When the stream function is activating, the **STREAM** button turns from solid white, then blinking red and finally to solid red.
- When the **STREAM** button is solid red, this indicates that the record function has been successfully activated.

### **Stop streaming**

- While streaming, the **STREAM** button is solid red.
- Press and hold the **STREAM** button for approximately 2 seconds.
- When the stream function is terminating, the **STREAM** button turns from solid red, then blinking red and finally to solid white.
- When the **STREAM** button is solid white, this indicates that the stream function has been successfully terminated.

## ***Bitrate Button***

Follow the steps below to switch the stream bitrate mode using the **BITRATE** button:

- Press and hold one of the **RECORD** button and **STREAM** button until the pressed button starts blinking red.
- Continue holding down one of the **RECORD** button and the **STREAM** button while pressing the **BITRATE** button to switch stream bitrate mode (H, M or L).

**Note: The system will return to original settings if the BITRATE button push is not sensed. The default bitrate is M.**

## ***Vertical Button***

Press the **Vertical** button to switch the input video orientation between **Portrait** and **Landscape** modes.

## **6.5 Restoring Factory Defaults**

On the system page, scroll down to **System Control** in which you should be able to find the **Restore to Default** button. Click to restore the system's factory defaults. Alternately, you can follow the steps below to restore the NVS-31 MARK IV's factory defaults.

- The **RECORD** and **STREAM** buttons are either solid white and solid red, which means the factory defaults can be restored regardless of the state of the device.
- Press and hold the **RECORD** and **STREAM** buttons simultaneously for more than 10 seconds.
- While the NVS-31 MARK IV's factory defaults are being restored, the **RECORD**, **STREAM**, **VERTICAL** and **BITRATE** buttons turn from solid red, then blinking red and finally to solid white.

- When the **RECORD**, **STREAM**, **VERTICAL** and **BITRATE** buttons turn solid white, it indicates that the NVS-31 MARK IV's factory defaults have been successfully restored.

## 6.6 Firmware Update

Datavideo usually releases new firmware containing new features or reported bug fixes from time to time. See the sections [System](#) → [Firmware Update](#) or [Appendix 3](#) for instructions on updating the NVS-31 MARK IV's firmware.

# Chapter 7 Appendices

## Appendix 1 Tally Outputs

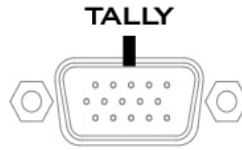

The SHOWCAST 100 has a D-sub 15 pin female tally output port. These connections provide bi-colour tally information to a number of other Datavideo products, such as the ITC-100 eight channel talkback system and the TLM range of LCD Monitors. The ports are open collector ports and as such do not provide power to tally light circuits.

The pin outputs are defined as follows:

PIN No.	Signal Name	Input/Output	Description of Signal
1	Program 1	Open collector output	Tally output of input video Program 1
2	--	--	No Function
3	Preview 1	Open collector output	Tally output of input video Preview 1
4	RCOM (GND)	Ground	Ground
5	Program 4	Open collector output	Tally output of input video Program 4
6	Program 2	Open collector output	Tally output of input video Program 2
7	--	--	No Function
8	Preview 2	Open collector output	Tally output of input video Preview 2
9	GND	Ground	Ground
10	--	--	No Function
11	Program 3	Open collector output	Tally output of input video Program 3
12	--	--	No Function
13	Preview 3	Open collector output	Tally output of input video Preview 3
14	YCOM (GND)	Ground	Ground
15	Preview 4	Open collector output	Tally output of input video Preview 4

## Appendix 2 RS-232/RS-422 Pinouts

The cameras can be connected to the SHOWCAST 100 4K ShowCast Studio through the RS-232 or RS-422 interface using a custom Ethernet cable. The corresponding connection wiring schemes are shown below.

### RS-232

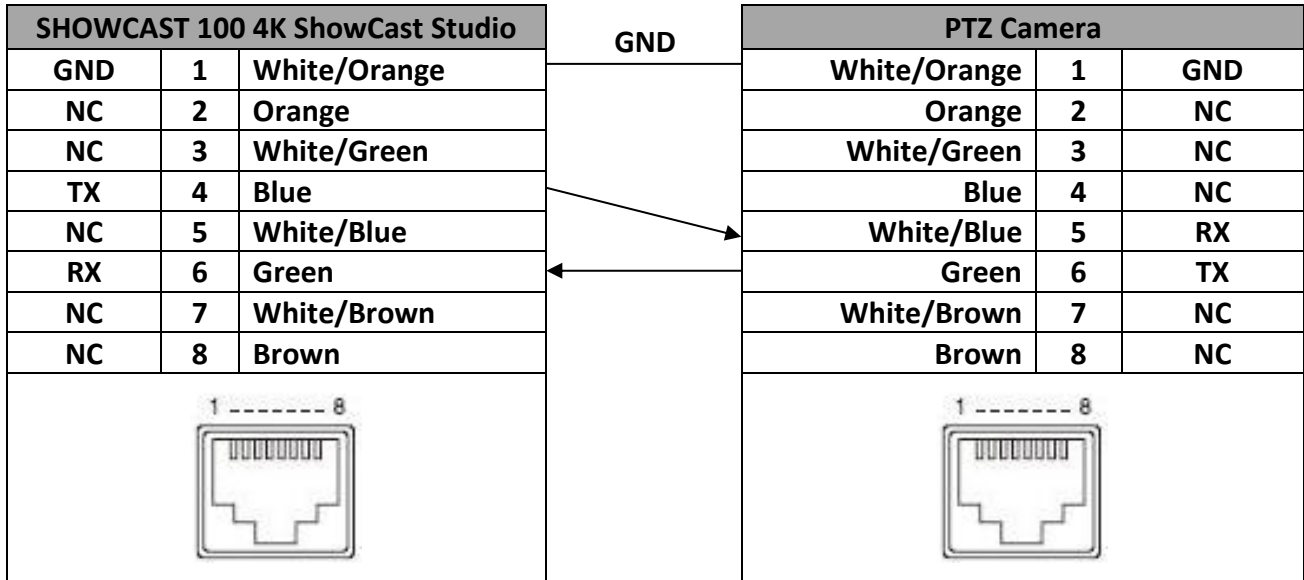

### RS-422

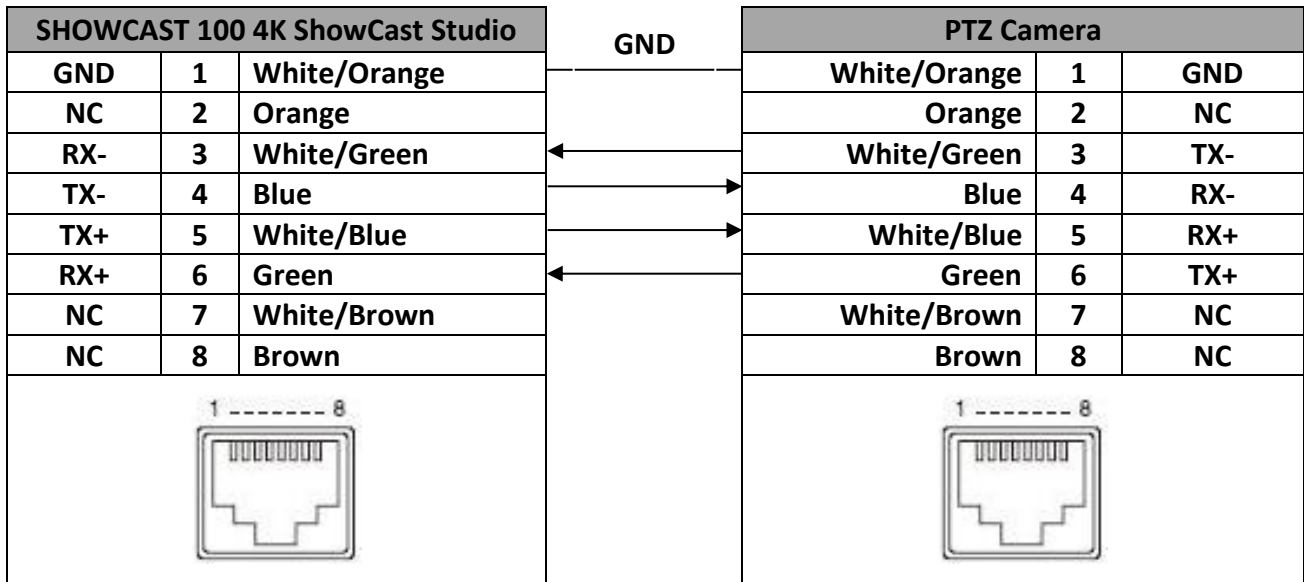



## Appendix 3      Firmware Upgrade

Datavideo usually releases new firmware containing new features or reported bug fixes from time to time. Customers can either download the SHOWCAST 100 firmware as they wish or contact their local dealer or reseller for assistance.

This section outlines the firmware upgrade process which should take ***approximately 10 minutes to complete***. The existing SHOWCAST 100 settings should persist through the ***firmware upgrade process, which should not be interrupted once started*** as this could result in a non-responsive unit.

### ***Keyboard / Mainboard***

**Successful firmware upgrade on SHOWCAST 100 requires:**

- SHOWCAST 100 x 1
- 12V Power adapter x 1
- USB thumb drive x 1
- Latest firmware files

### **Update Procedure**

1. Download the latest firmware files from the official product page.
2. Save the files on the USB thumb drive.
3. Insert the thumb drive into the F/W Upgrade port.
4. Open OSD menu then select Setup → Firmware Upgrade → Update
5. The SHOWCAST 100 will perform a firmware upgrade automatically and restart as soon as the upgrade is complete.

### ***Video Streaming Server***

**To update the video streaming server, you will need:**

- The latest firmware for the video streaming server.  
This firmware file can be obtained from your local Datavideo office or dealer or product page.
- SHOWCAST 100 x 1
- 12V Power adapter x 1

### **Update Procedure**

1. Visit the official product page <https://www.datavideo.com/tw/product/showcast100> to download the latest firmware file.
2. Login the streaming encoder's web interface, then click the **System** tab to open the system configuration page.
3. Scroll down to **Firmware Update** then click the **Browse** button to search for the latest firmware file on the PC's hard disk.

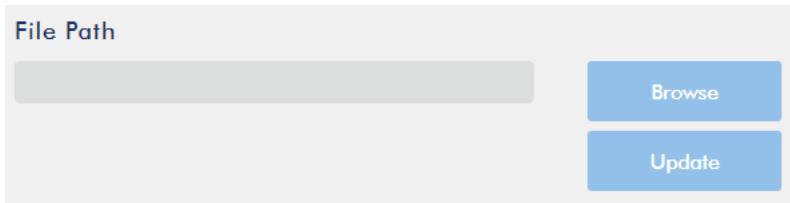

4. After double clicking the firmware file, you will see the loading prompt as shown below, indicating that the file is being uploaded to the streaming encoder.

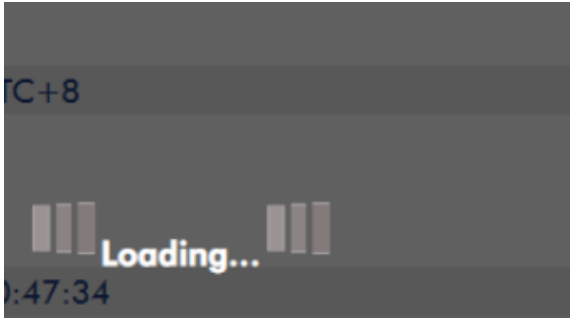

5. After the file has been successfully uploaded, you will see a file upload success message. Click the **Update** button to start the firmware update process.



6. The device will reboot itself after it is updated successfully.

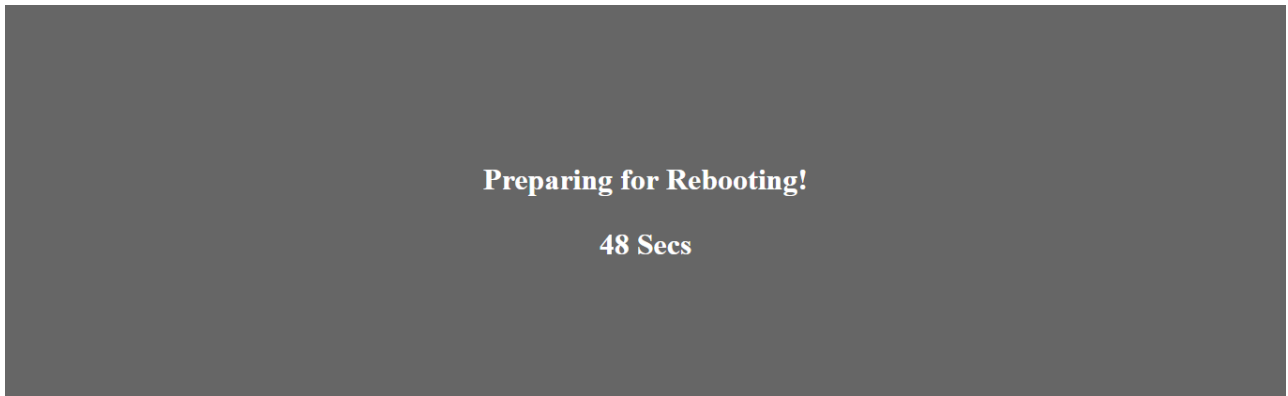







**Note: If the device is recording or streaming, you must turn them off before initiating the firmware update.**

## Appendix 4 Recommended SD Cards

You should only use Class 10 SD card or above. In this appendix, you will find a list of SD cards recommended by Datavideo.

Recommended SD Cards			
No.	Brand	Model	Pictures
1	Kingston	SDHC   C10 16GB	
2	SANDISK Extreme	SDXC   C10 U3 V30 64GB	
3	SONY	SDXC   C10 U1 64GB	
4	SANDISK Extreme PRO	SDXC   C10 U3 128GB/64GB	 
5	SONY	SDXC   C10 U3 64GB	
6	TOSHIBA	SDHC C10 16GB	

Recommended SD Cards			
No.	Brand	Model	Pictures
7	SANDISK Extreme	SDHC C10 16GB	
8	ADATA Premier Pro	microSDXC I UHS-I U3 Class 10 with SD adapter 64GB/16GB	 
9	SANDISK ULTRA®	SDHC™/SDXC™ UHS-I 128GB	
10	Transcend	300S UHS-I SDHC 64GB/32GB	 

## Appendix 5      Frequently-Asked Questions

This section describes problems that you may encounter while using SHOWCAST 100. If you have any questions, please refer to related sections and follow all suggested solutions. If problem still exists, please contact your distributor or the service center.

No.	Problems	Solutions
1.		
2.		
3.		

## Appendix 6 Dimensions

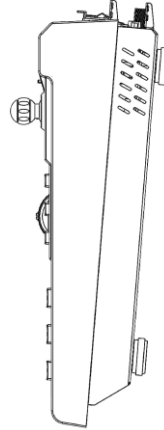
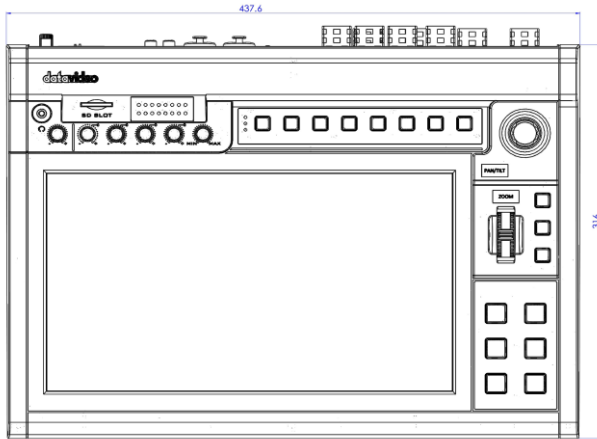
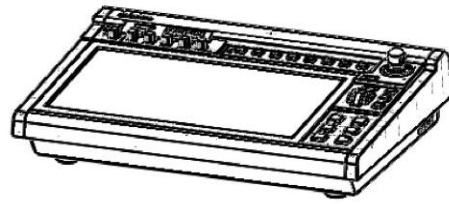
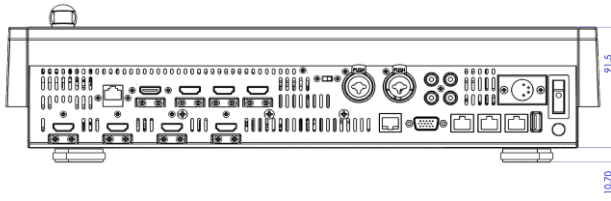

All measurements in millimeters (mm)

## Appendix 7 Specifications

<b>Model Name</b>	<b>SHOWCAST 100</b>
<b>Product Name</b>	<b>4K SHOWCAST STUDIO</b>
<b>Video Standard</b>	4K & HD
<b>Video Format</b>	<p>Input:            3840x2160p: 60/59.94/50/30/29.97/25/24/23.98            1080p: 60/59.94/50/30/29.97/25/24/23.98            1080i: 60/59.94/50, 720p: 60/59.94/50            480p, 576p, 480i, 576i            VGA, XGA (1024 x 768), SXGA (1280 x 1024),            UXGA (1600 x 1200), WUXGA (1920 x 1200)</p> <p>Output:            3840x2160p: 60/59.94/50/30/29.97/25/24/23.98            1080p: 60/59.94/50/30/29.97/25/24/23.98            1080i: 60/59.94/50, 720p: 60/59.94/50</p>
<b>Video Processing</b>	<p>4K60            YUV4:4:4 8bit, YUV 4:2:2 8/10bit, YUV 4:2:0 8bit, RGB 4:4:4 8bit            4K30            YUV4:4:4 8/10/12bit, YUV 4:2:2 8/10/12bit, YUV 4:2:0 8bit,            RGB 4:4:4 8/10/12bit            HD            YUV4:4:4 8/10/12bit, YUV 4:2:2 8/10/12bit, RGB 4:4:4 8/10/12bit</p>
<b>Input Routable / Crosspoint</b>	N/A
<b>Video Input</b>	4 x HDMI 2.0
<b>Mix HD &amp; SD Source</b>	N/A
<b>Computer Graphical Interface</b>	4 via HDMI
<b>Video Output</b>	<p>3 x HDMI 2.0 for PGM            1 x HDMI for CG Preview</p>
<b>Down-Converted Output</b>	Yes
<b>Built-in Multi-View Monitoring Out</b>	On 14" Touch Panel
<b>Analogue Audio Input</b>	<p>2 x 3pin XLR / 1/4" (6.3 mm) Combo Socket            1 x Stereo RCA set (L/R)</p>
<b>Analogue Audio Output</b>	<p>1 x Stereo RCA set (L/R)            1 x Stereo Headphone (Mini Jack with volume control)</p>
<b>Digital Embedded Audio Support</b>	<p>Input: 2 Channels            Output: 2 Channels</p>
<b>Audio Delay Calibration</b>	up to 200 ms
<b>A+V Switching</b>	Yes

<b>Chromakey</b>	N/A
<b>Title Creator</b>	Web GUI
<b>USK</b>	Luma Key
<b>DSK</b>	N/A
<b>Picture in Picture</b>	1
<b>Logo Insertion</b>	N/A
<b>Still Store</b>	N/A
<b>Effects</b>	Seamless Cut, WIPE, Mix
<b>Transition Preview</b>	N/A
<b>Sync / Reference In / Out</b>	Built-in Genlock (internal)
<b>Tally Output</b>	D-sub 15pin Male Connector
<b>PC Remote Control</b>	Web browser UI for configuration and control Socket commands
<b>Camera Control</b>	DVIP / RS-422 / RS-232
<b>Built-in Audio Mixer</b>	Yes
<b>Storage</b>	1 x SD Card Slot Supports SD, SDHC and SDXC card (UHS-I) (Class 10 above)
<b>Recording File System</b>	FAT, NTFS, exFAT
<b>Recording File Format</b>	MP4
<b>Video Encode</b>	H.264 / AVC, Main / High Profile Record Only: Up to 16 Mbps (1080p50/60) Stream Only: Up to 10 Mbps (1080p50/60) Rec and Stream: Up to 10 Mbps (1080p25/30) Rec and Stream: Up to 36 Mbps (1080p50/60) Dual Stream
<b>Audio Encode</b>	AAC-LC Configurable bit rate ranging from 32 Kbps to 384 Kbps Sample Rate: 48 kHz, 16 bit
<b>Streaming Protocol</b>	TS over TCP/UDP (unicast & multicast) RTSP over HTTP/TCP/UDP (RTSP Elementary Streaming RTMP (Publish)
<b>Firmware Update</b>	Ethernet, USB
<b>Special Features</b>	14.0" Touchscreen Display
<b>Chassis</b>	Unibody
<b>Dimensions (LxWxH)</b>	437.6 x 330.5 x 96.5 mm
<b>Weight</b>	5.4 kg
<b>Power</b>	DC 12V 82W
<b>Operating Temperature</b>	0°C - 40°C [32°F - 104°F]



## Notes

---

## Notes

---

## Notes

---

## Service & Support

It is our goal to make owning and using Datavideo products a satisfying experience. Our support staff is available to assist you to set up and operate your system. Contact your local office for specific support requests. Plus, please visit [www.datavideo.com](http://www.datavideo.com) to access our FAQ section.

Please visit our website for latest manual update.

[www.datavideo.com/product/SHOWCAST\\_100](http://www.datavideo.com/product/SHOWCAST_100)

**datavideo**  
[www.datavideo.com](http://www.datavideo.com)



@DatavideoUSA @DatavideoIndia2016  
@DatavideoEMEA @Datavideojapan  
@DatavideoTaiwan @DatavideoLatam  
@DatavideoAsia @DatavideoBrasil



@Datavideo  
@Datavideo\_EMEA  
@Datavideo\_Taiwan



@DatavideoUSA  
@DVTWDCN



@DatavideoUSA  
@DatavideoEurope

All the trademarks are the properties of their respective owners.  
Datavideo Technologies Co., Ltd. All rights reserved 2020

Jul-05.2022  
Version E1