

datavideo

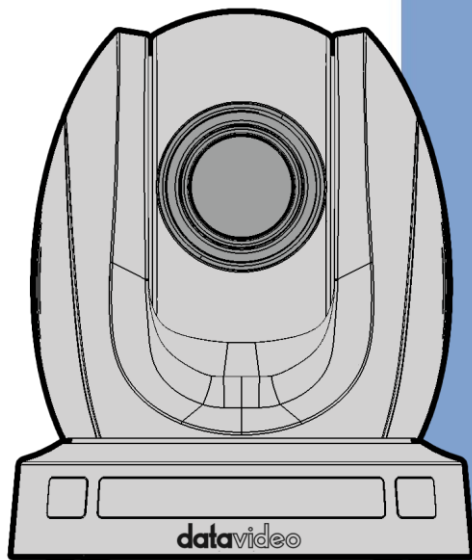

NDI PTZ CAMERA

PTC-140NDI

Instruction Manual

www.datavideo.com

Table of Contents

TABLE OF CONTENTS	2
FCC COMPLIANCE STATEMENT	4
WARNINGS AND PRECAUTIONS	4
WARRANTY	5
<i>STANDARD WARRANTY</i>	5
<i>THREE YEAR WARRANTY</i>	6
DISPOSAL	7
1. PRODUCT OVERVIEW	8
<i>FEATURES</i>	8
2. LOCATION AND FUNCTION OF PARTS	9
3. BASIC SETUP	13
3.1 POWER-ON INITIALIZATION.....	13
3.2 VIDEO OUTPUT.....	13
<i>NDI® HX/DVIP Port</i>	13
<i>HDMI Video Output</i>	15
<i>3G-SDI Video Output</i>	15
4. HOW TO USE THE NDI STUDIO MONITOR SOFTWARE	16
4.1 NDI INTRODUCTION	16
4.2 HOW TO USE THE NDI STUDIO SOFTWARE (TAKE WINDOWS 10 FOR EXAMPLE) .	16
5. REMOTE CONTROL AND ON-SCREEN MENU	20
5.1 REMOTE CONTROL FUNCTIONS.....	20
5.2 ON-SCREEN MENU	25
5.3 PROFESSIONAL JARGON EXPLANATIONS OF THE OSD MENU	34
6. INSTALLATION INSTRUCTIONS	35
7. NETWORK CONNECTION	39
7.1 DHCP MODE.....	40
7.2 STATIC IP	42
7.3 DVIP.....	42

8.	WEB USER INTERFACE	46
8.1	PREVIEW	46
	<i>Control Functions</i>	46
	<i>Preset</i>	48
8.2	CONFIGURATION	49
	<i>Audio Configure</i>	49
	<i>Video Configure</i>	51
	<i>Network Configure</i>	77
	<i>System Configure</i>	79
9.	REMOTE CONTROL PORT PINOUTS	83
10.	FIRMWARE UPDATE	85
	REQUIREMENTS	85
	PROCEDURE	85
11.	FREQUENTLY-ASKED QUESTIONS.....	86
12.	DIMENSIONS.....	87
13.	SPECIFICATIONS	88
	SERVICE & SUPPORT	91

Disclaimer of Product and Services

The information offered in this instruction manual is intended as a guide only. At all times, Datavideo Technologies will try to give correct, complete and suitable information. However, Datavideo Technologies cannot exclude that some information in this manual, from time to time, may not be correct or may be incomplete. This manual may contain typing errors, omissions or incorrect information. Datavideo Technologies always recommend that you double check the information in this document for accuracy before making any purchase decision or using the product. Datavideo Technologies is not responsible for any omissions or errors, or for any subsequent loss or damage caused by using the information contained within this manual. Further advice on the content of this manual or on the product can be obtained by contacting your local Datavideo Office or dealer.

FCC Compliance Statement

This device complies with part 15 of the FCC rules. Operation is subject to the following two conditions:

- (1) This device may not cause harmful interference, and
- (2) This device must accept any interference received, including interference that may cause undesired operation.

Warnings and Precautions

1. Read all of these warnings and save them for later reference.
2. Follow all warnings and instructions marked on this unit.
3. Unplug this unit from the wall outlet before cleaning. Do not use liquid or aerosol cleaners. Use a damp cloth for cleaning.
4. Do not use this unit in or near water.
5. Do not place this unit on an unstable cart, stand, or table. The unit may fall, causing serious damage.
6. Slots and openings on the cabinet top, back, and bottom are provided for ventilation. To ensure safe and reliable operation of this unit, and to protect it from overheating, do not block or cover these openings. Do not place this unit on a bed, sofa, rug, or similar surface, as the ventilation openings on the bottom of the cabinet will be blocked. This unit should never be placed near or over a heat register or radiator. This unit should not be placed in a built-in installation unless proper ventilation is provided.
7. This product should only be operated from the type of power source indicated on the marking label of the AC adapter. If you are not sure of the type of power available, consult your Datavideo dealer or your local power company.
8. Do not allow anything to rest on the power cord. Do not locate this unit where the power cord will be walked on, rolled over, or otherwise stressed.
9. If an extension cord must be used with this unit, make sure that the total of the ampere ratings on the products plugged into the extension cord do not exceed the extension cord's rating.

10. Make sure that the total amperes of all the units that are plugged into a single wall outlet do not exceed 15 amperes.
11. Never push objects of any kind into this unit through the cabinet ventilation slots, as they may touch dangerous voltage points or short out parts that could result in risk of fire or electric shock. Never spill liquid of any kind onto or into this unit.
12. Except as specifically explained elsewhere in this manual, do not attempt to service this product yourself. Opening or removing covers that are marked “Do Not Remove” may expose you to dangerous voltage points or other risks, and will void your warranty. Refer all service issues to qualified service personnel.
13. Unplug this product from the wall outlet and refer to qualified service personnel under the following conditions:
 - a. When the power cord is damaged or frayed;
 - b. When liquid has spilled into the unit;
 - c. When the product has been exposed to rain or water;
 - d. When the product does not operate normally under normal operating conditions. Adjust only those controls that are covered by the operating instructions in this manual; improper adjustment of other controls may result in damage to the unit and may often require extensive work by a qualified technician to restore the unit to normal operation;
 - e. When the product has been dropped or the cabinet has been damaged;
 - f. When the product exhibits a distinct change in performance, indicating a need for service.

Warranty

Standard Warranty

- Datavideo equipment are guaranteed against any manufacturing defects for one year from the date of purchase.
- The original purchase invoice or other documentary evidence should be supplied at the time of any request for repair under warranty.
- The product warranty period begins on the purchase date. If the purchase date is unknown, the product warranty period begins on the thirtieth day after shipment from a Datavideo office.

- All non-Datavideo manufactured products (product without Datavideo logo) have only one year warranty from the date of purchase.
- Damage caused by accident, misuse, unauthorized repairs, sand, grit or water is not covered under warranty.
- Viruses and malware infections on the computer systems are not covered under warranty.
- Any errors that are caused by unauthorized third-party software installations, which are not required by our computer systems, are not covered under warranty.
- All mail or transportation costs including insurance are at the expense of the owner.
- All other claims of any nature are not covered.
- All accessories including headphones, cables, and batteries are not covered under warranty.
- Warranty only valid in the country or region of purchase.
- Your statutory rights are not affected.

Three Year Warranty

- All Datavideo products purchased after July 1st, 2017 are qualified for a free two years extension to the standard warranty, providing the product is registered with Datavideo within 30 days of purchase.
- Certain parts with limited lifetime expectancy such as LCD panels, DVD drives, Hard Drive, Solid State Drive, SD Card, USB Thumb Drive, Lighting, Camera module, PCIe Card are covered for 1 year.
- The three-year warranty must be registered on Datavideo's official website or with your local Datavideo office or one of its authorized distributors within 30 days of purchase.



Disposal



For EU Customers only - WEEE Marking

This symbol on the product or on its packaging indicates that this product must not be disposed of with your other household waste. Instead, it is your responsibility to dispose of your waste equipment by handing it over to a designated collection point for the recycling of waste electrical and electronic equipment. The separate collection and recycling of your waste equipment at the time of disposal will help to conserve natural resources and ensure that it is recycled in a manner that protects human health and the environment. For more information about where you can drop off your waste equipment for recycling, please contact your local city office, your household waste disposal service or the shop where you purchased the product.



CE Marking is the symbol as shown on the left of this page. The letters "CE" are the abbreviation of French phrase "Conformité Européene" which literally means "European Conformity". The term initially used was "EC Mark" and it was officially replaced by "CE Marking" in the Directive 93/68/EEC in 1993. "CE Marking" is now used in all EU official documents.

1. Product Overview

The PTC-140NDI is a low-cost SDI/HDMI PTZ camera, which features 20x optical zoom and 10x digital zoom. The PTC-140NDI is an IP camera as well for supporting H.264 /H.265 video compression and dual stream output. It features NDI® | HX, which is the first NDI camera launched by Datavideo.

Features

- 1/2.8 inch CMOS sensor. Resolution is up to 1920x1080 with frame rate up to 60fps.
- Low Noise CMOS effectively ensures high SNR of camera video. Advanced 2D/3D noise reduction technology is also used to further reduce the noise, while ensuring image sharpness.
- Audio Input Interface
- Supports AAC, MP3 and G.711A audio coding with sampling frequencies of 16000, 32000, 44100 and 48000.
- Supports H.264/H.265 video compressions of resolution up to 1920x1080 with frame rate up to 60fps, AAC, MP3 and G.711A audio compressions and 2-channel 1920x1080p with 30fps video compression.
- Supports multiple network protocols such as RTSP and RTMP allowing you to easily link to any streaming media servers.
- Supports Simultaneous Video Outputs by NDI® | HX, 3G SDI and HDMI interfaces for up to 1080p60 resolution.

2. Location and Function of Parts

Front of Camera	
	
1	Lens Built-in 1/2.8" 2.07M Pixel CMOS HD color camera with white balance control, backlight compensation, automatic gain and etc.
2	Tally LED Tally lamp will be turned ON upon receiving the ON signal.
3	Sensor for Remote Control Remote control IR receiver

Rear of Camera



1	Power Input DC in socket connects the supplied 12V PSU. The connection can be secured by screwing the outer fastening ring of the DC In plug to the socket.
2	NDI® HX & DVIP Interface NDI® HX interface allows users to connect the PTC-140NDI and a PC to the RJ-45 Ethernet interfaces of the same router by using an RJ-45 Ethernet cable. Moreover, users can set the PC and the PTC-140NDI camera in the same local area network for controlling some functions of the PTC-140NDI camera by NewTek's "NDI Studio Monitor" software. The most important benefit that the NDI brings to users is that it allows

	<p>the output screen of the PTC-140NDI camera to be auto-recognized by the NDI compatible receiving devices (e.g. Notebook PC) which are set in the same local area network.</p> <p>The DVIP interface allows users to control the PTC-140NDI camera by the proprietary DVIP protocol which is developed by Datavideo.</p>
3	<p>HDMI OUT</p> <p>The HDMI OUT allows you to connect an external HDMI monitor via an HDMI cable.</p>
4	<p>3G-SDI OUT</p> <p>The 3G-SDI OUT allows you to connect an external monitor via an SDI cable.</p>
5	<p>Audio IN</p> <p>The 3.5mm audio input receives external audio.</p>
6	<p>RS-422/RS-485 Interface (RJ-45)</p> <p>The RS-485 interface serves to connect external RS-422/RS-485 devices. Use an Ethernet cable to connect external RS-422/RS-485 controllers. See "Section 9 Remote Control Port Pinouts" for making the cable for the RS-422/RS-485 interface.</p> <p>Note: To switch between RS-422 and RS-485 communication protocols, open OSD menu, then go to Setup → RS-485/422 in which you will be allowed to select the appropriate protocol.</p>
7	<p>RS-232 Interface (RJ-45)</p> <p>The RS-232 interface connects PTC-140NDI to a remote controller or PC for control purpose. Use an Ethernet cable to connect external RS-232 controllers. See "Section 9 Remote Control Port Pinouts" for making the cable for the RS-232 interface.</p>

Bottom of Camera

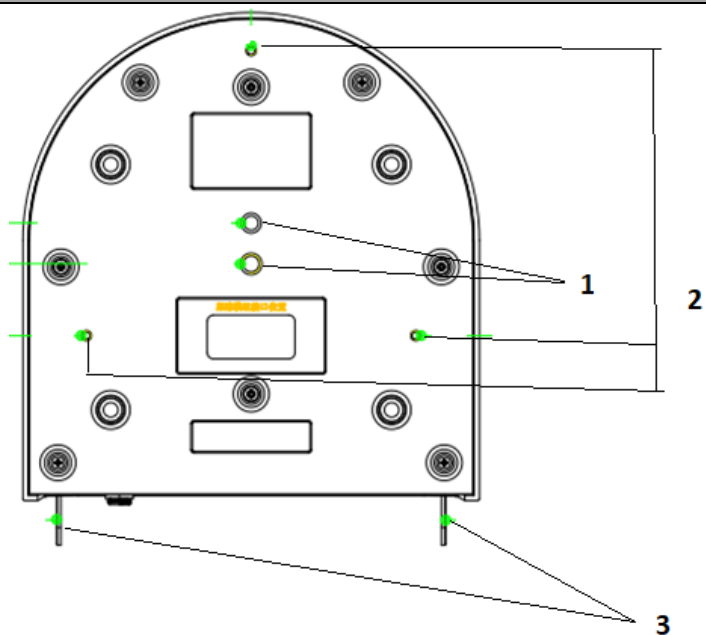

1	Tripod Screw Hole allows the user to mount the camera on the tripod.
2	Screw Hole Screw holes for ceiling bracket mounting.
3	For Safety Rope Ties safety rope for fixing the camera to the ceiling.

3. Basic Setup

3.1 Power-On Initialization

As shown in the diagram below, after you plug in the power cord, the tally light in the front will start flashing red and will be OFF as soon as the power-on initialization is complete. The camera head should be at the HOME position with the lens facing front. However, if preset 0 is set, it will return to the 0th preset position.



Connect the DC 12 V power adapter

3.2 Video Output

You are allowed to view the camera video via **NDI® | HX/DVIP port, HDMI OUT** and **3G-SDI OUT**.

NDI® | HX/DVIP Port



Follow the instructions below to view your video on the web user interface.

- **Connect the PTC-140NDI camera directly to your PC/Notebook PC**
 1. Connect the PTC-140NDI to the PC/Notebook using an Ethernet cable.
 2. On your PC/Notebook, open the web browser and enter camera's default IP address into the address bar.

Note: The default static IP address is 192.168.5.163

3. On the Login page enter the username and password which are admin/admin respectively by default.
4. Click into the preview window on which the video will be displayed.

● **Connect the PTC-140NDI camera to your PC or Notebook PC through a router**

1. Please set the Ethernet IP address of your PC or Notebook PC as 192.168.5.x (x means 0-255) and then the PC or Notebook PC will be within the same local area network as the PTC-140 NDI camera.

2. Please use an RJ-45 Ethernet cable to connect from the NDI® | HX/DVIP port which is located on the rear panel of the PTC-140NDI to the LAN of a router. And then please use another RJ-45 Ethernet cable to connect from the RJ-45 Ethernet interface of your PC or Notebook PC to the LAN port of the same router.

3. On your PC/Notebook, open the web browser and enter camera's default IP address into the address bar.

Note: PTC-140NDI's default static IP address is 192.168.5.163

4. On the Login page enter the username and password which are admin/admin respectively by default.
5. Click into the preview window on which the video will be displayed.

HDMI Video Output



Connect the HDMI OUT to an external connected monitor using an HDMI cable.

3G-SDI Video Output



Connect the SDI OUT to an external connected monitor using an SDI cable.

4. How to Use the NDI Studio Monitor Software

4.1 NDI Introduction

NDI is an Ethernet-based open video and audio transmission standard. NDI allows bilateral video and audio signal transmission for devices which are located within the same Local Area Network. It provides low-latency and real-time features which make it an ideal solution for the live production application.

4.2 How to Use the NDI Studio Software (Take Windows 10 for Example)

Please follow following steps for using the NDI Studio Monitor software.

1. At first, please confirm that your PTC-140 NDI camera and your laptop are connected to a router and they are set in the same Local Area Network.

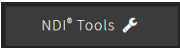
2. Please connect to NetTek NDI official web page <https://www.ndi.tv/>, and then please press “NDI Tools” . After that, please press “Download”



to download the latest version NDI Tools software.

3. After the installation is finished, please press “Studio Monitor” to open the NDI Studio Monitor software.

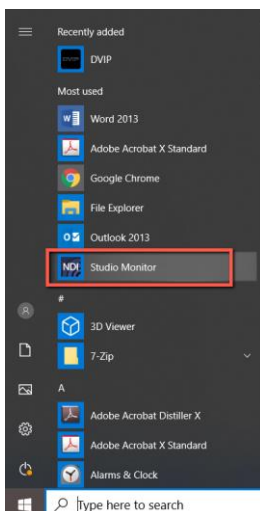

4. After the Studio Monitor Software is launched, its interface will be shown as following diagram.



5. Please move your mouse cursor to the top-left side and then click the menu button. After that, you can see the Studio Monitor menu. You can also right-click on the Studio Monitor interface for showing the menu.



6. From the menu, users can see that the PTC-140NDI camera which is connected to the same local area network as the Studio Monitor is detected successfully. Please click it and then users can see the screen which is shot by the PTC-140NDI is shown as following diagram. For the device which is connected to the same local area network, users can enter the IP address into the address bar of the web browser for connecting to the Studio Monitor web control UI.



7. From the menu, please select Settings->PTZ Settings->Show PTZ Controls, and then the PTZ control interface will be shown on the interface for users to control functions including pan and tilt directions, Auto Focus, Zoom and preset-saving and preset-recalling of the camera lens.

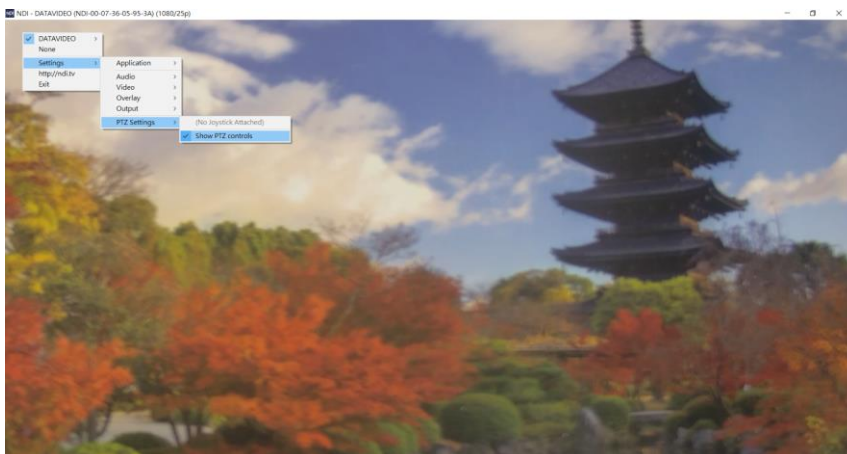





Note: If you have any problems when installing or using the NDI Studio Monitor software, please refer to NewTek NDI website <https://www.ndi.tv/> or please contact NewTek NDI Technical Support Team.



5. Remote Control and On-Screen Menu





This chapter provides an overview of remote control functions and OSD menu.



5.1 Remote Control Functions

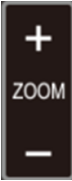

No	Function Keys	Descriptions
1	<p style="text-align: center;">Standby Key</p> 	<p>Standby Key The standby button turns ON/OFF the camera.</p> <p>To reboot the camera, press the standby button for 3 seconds. After device initialization is complete, the camera head will automatically return to HOME position.</p>
2	<p style="text-align: center;">Camera Select Keys</p> 	<p>Camera Select Keys To select a camera in a multi-camera environment using camera select keys (CAM1 – CAM4), you should first assign an ID number to the camera intended for operation using F1 – F4 keys then press CAMERA SELECT (CAM 1~ CAM4) keys to navigate between the four cameras.</p> <p>Note: See F1 – F4 keys for ID number assignment instructions.</p>
3	<p style="text-align: center;">Number Keypad</p> 	<p>Number Keypad Set, recall and clear presets using the number keypad.</p> <p>Set Preset Please press the SET PRESET at first, and then please press any of the number keys from 0 to 9 to save the PTZ settings. You will be allowed to save up to up to 10 presets using the remote control.</p> <p>Call Preset Press any of the number keys from 0 to 9 to recall the preset settings. Note: Make sure the preset that you want to recall contains PTZ settings before pressing the number key.</p> <p>Clear Preset First press the CLEAR/PRESET key then the number key (0 – 9) to empty the preset.</p>

No	Function Keys	Descriptions
4	<p data-bbox="221 628 437 683">Asterisk and Pound Keys</p> 	<p data-bbox="468 161 978 248">The asterisk and pound keys form various combinations with other keys to access certain functions directly.</p> <p data-bbox="468 260 844 284">The shortcuts are listed as follows:</p> <ol data-bbox="479 293 1020 1230" style="list-style-type: none"> <li data-bbox="479 293 930 319">1. 【#】 + 【#】 + 【#】 : Clear all presets <li data-bbox="479 327 1020 352">2. 【*】 + 【#】 + 【6】 : Restore factory defaults <li data-bbox="479 360 930 421">3. 【*】 + 【#】 + 【9】 : Image flip along horizontal axis <li data-bbox="479 429 953 489">4. 【*】 + 【#】 + AUTO: Enable auto focus mode <li data-bbox="479 497 919 558">5. 【*】 + 【#】 + 【3】 : Set OSD MENU language to Chinese. <li data-bbox="479 566 919 627">6. 【*】 + 【#】 + 【4】 : Set OSD MENU language to English. <li data-bbox="479 635 1020 695">7. 【*】 + 【#】 + MANUAL: Restore default user name, password, and IP address. <li data-bbox="479 703 967 764">8. 【#】 + 【#】 + 【0】 : Set video format to 1080P60. <li data-bbox="479 772 967 833">9. 【#】 + 【#】 + 【1】 : Set video format to 1080P50 <li data-bbox="479 841 967 901">10. 【#】 + 【#】 + 【2】 : Set video format to 1080I60 <li data-bbox="479 909 967 970">11. 【#】 + 【#】 + 【3】 : Set video format to 1080I50 <li data-bbox="479 978 967 1038">12. 【#】 + 【#】 + 【4】 : Set video format to 720P60 <li data-bbox="479 1046 967 1107">13. 【#】 + 【#】 + 【5】 : Set video format to 720P50 <li data-bbox="479 1115 967 1176">14. 【#】 + 【#】 + 【6】 : Set video format to 1080P30 <li data-bbox="479 1184 967 1244">15. 【#】 + 【#】 + 【7】 : Set video format to 1080P25
5	<p data-bbox="262 1305 398 1329">AUTO Focus</p> 	<p data-bbox="468 1329 605 1353">AUTO Focus</p> <p data-bbox="468 1361 967 1385">Pressing this key will enable auto focus mode.</p>

No	Function Keys	Descriptions
6	<p>Manual Mode</p> 	<p>Manual Focus Pressing this key enables manual mode allowing you to adjust the camera's focus and zoom by pressing Focus+/- and Zoom+/- keys.</p>
7	<p>Focus +/-</p> 	<p>Focus Press and hold Focus+ or Focus- to adjust the focus accordingly and release as soon as the desired focus is reached.</p> <p>Note: Before adjusting the focus using Focus +/- key, press the manual key to enable manual mode.</p>
8	<p>Zoom In (+) / Zoom Out (-)</p> 	<p>Zoom Press and hold Zoom + or Zoom- to zoom in and out respectively and release as soon as the desired zoom is reached.</p> <p>Note: Before adjusting the zoom using Zoom +/- key, press the manual key to enable manual mode.</p>
9	<p>SET PRESET</p> 	<p>SET PRESET Press SET PRESET to set presets. See Number Keypad description for instructions.</p>
10	<p>CLEAR PRESET</p> 	<p>CLEAR PRESET Press CLEAR PRESET to clear presets. See Number Keypad description for instructions.</p>

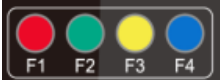
No	Function Keys	Descriptions
11-13	<p>Direction Arrows</p> 	<p>Direction Arrow Keys Press the arrow keys to move the camera head up, down, left and right.</p> <p>Home Key Press Home to return the camera head to the center.</p> <p>Note: In the OSD menu, press Home to enter the selected option item and MENU to exit.</p>
14	<p>MENU</p> 	<p>MENU Open or close the camera's OSD menu.</p>
15	<p>BLC ON/OFF</p> 	<p>BLC ON/OFF Press BLC ON/OFF to turn ON/OFF the backlight compensation.</p>
16	<p>F1 – F4 Keys</p> 	<p>F1 – F4 Keys Assign an ID number to the camera intended for operation using F1 – F4 keys by pressing the combination keys as described below.</p> <ul style="list-style-type: none"> • CAM1: [*] + [#] + [F1] • CAM2: [*] + [#] + [F2] • CAM3: [*] + [#] + [F3] • CAM4: [*] + [#] + [F4] <p>Use Camera Select keys to select the camera intended for operation after you've assigned an ID number to each camera.</p>

Note: If users press the *+#+MANUAL buttons, the IP address of the PTC-140NDI will be resumed to factory default 192.168.5.163

5.2 On-Screen Menu

On-Screen Menu allows the user to modify various camera settings. Press **[MENU]** on the **remote control** to open the on-screen menu as shown below.

On-Screen MENU	
Language	
Setup	
Camera	
P/T/Z	
Video Format	
Version	
Restore Default	
Escape	
[↑↓] Select	[← →] Change Value
[Menu] Back	[Home] OK

The table below summarizes the main option items and their sub-options.

Main Options							
	Language	Setup	Camera	P/T/Z	Video Format	Version	Restore Default
Sub-Options	English	Protocol	Exposure	Speed by Zoom	1080P60	MCU Version	Restore Default
	Simplified Chinese	VISCA Address	Color	Zoom Speed	1080P50	Camera Version	
		VISCA Address Fix	Image	Acc Curve	1080I60	AF Version	
		PELCO-P Address	Focus	Preset Speed	1080I50		
		PELCO-D Address	Noise Reduction	Joystic Pan Dir	1080P30		
		Baudrate	Style	Joystic Tilt Dir	1080P25		
		RS-485/422			720P60		
					720P50		
					1080P59.94		
					1080I59.94		
					1080P29.97		
					720P59.94		

Details of all options in the on-screen menu are listed in the table below.

Main Menu	Sub Menu	Options	Sub-options
Language	English		
	Simplified Chinese		
Setup	Protocol	Auto	
		VISCA	
		PELCOO-D	
		PELCCO-P	
	VISCCA Address	1-7	
	VISCA Address Fix	ON/OFF	
	PELCO-P Address	1-255	
	PELCO-D Address	1-255	
	Baudrate	2400	
		4800	
		9600	
		38400	
		115200	
	RS-485/422	RS-485	
RS-422			
Camera	Exposure	Mode	Auto
			Manual
			SAE
			AAE
			Bright
		EV	ON
			OFF
		EV Level	0
			1
			2
	3		
	4		
	5		
	6		
	7		
-7			
-6			
-5			
-4			
-3			

Main Menu	Sub Menu	Options	Sub-options
			-2
			-1
		BLC	ON
			OFF
		Flicker	OFF
			50Hz
			60Hz
		Gain Limit	0~15
		DRC	Closed
			1
			2
			3
			4
			5
	6		
	7		
		8	
	Color	WB Mode	Auto
			3000K
			3500K
			4000K
			4500K
			5000K
			5500K
			6000K
			6500K
			7000K
Manual			
Onepush			
RG Tuning		0	
	1		
	2		
	3		
	4		
	5		
	6		
	7		
8			
	9		

Main Menu	Sub Menu	Options	Sub-options
			10
			-10
			-9
			-8
			-7
			-6
			-5
			-4
			-3
			-2
			-1
			0
			1
			2
			3
			4
			5
			6
			7
			8
			9
		BG Tuning	10
			-10
			-9
			-8
			-7
			-6
			-5
			-4
			-3
			-2
			-1
			60%
			70%
			80%
		Saturation	90%
			100%
			110%
			120%

Main Menu	Sub Menu	Options	Sub-options
			130%
			140%
			150%
			160%
			170%
			180%
			190%
			200%
		Hue	0
			1
			2
			3
			4
			5
			6
			7
			8
			9
			10
			11
			12
	13		
	14		
	AWB Sensitivity	High	
		Low	
		Middle	
	Image	Brightness	0
			1
			2
			3
			4
			5
			6
7			
8			
9			
10			
11			
12			

Main Menu	Sub Menu	Options	Sub-options
			13
			14
		Contrast	0
			1
			2
			3
			4
			5
			6
			7
			8
			9
			10
			11
			12
			13
		14	
		Sharpness	0
			1
			2
			3
			4
			5
			6
			7
			8
			9
			10
			11
			12
			13
			14
		15	
Flip-H	ON		
	OFF		
Flip-V	ON		
	OFF		
B & W Mode	Color		
	Black & White		

Main Menu	Sub Menu	Options	Sub-options
		Gamma	Default
			0.45
			0.50
			0.55
			0.63
		DCI	Closed
			1
			2
			3
			4
			5
			6
			7
	8		
	Focus	Focus Mode	Auto
			Manual
			Onepush
		AF-Zone	Top
			Center
			Bottom
			All
		AF-Sensitivity	High
			Low
Middle			
Noise Reduction	NR-2D	Auto	
		OFF	
		1	
		2	
		3	
		4	
		5	
		6	
	7		
	NR-3D	OFF	
		1	
		2	
		3	
		4	
5			

Main Menu	Sub Menu	Options	Sub-options
			6
			7
			8
		Dynamic Hot Pixel	OFF
			1
			2
			3
			4
		Style	5
			Default
Normal			
Clarity			
Bright			
P/T/Z	Zoom by Speed	Soft	
		ON	
	Zoom Speed	OFF	
		1	
		2	
		3	
		4	
		5	
		6	
		7	
	Acc Curve	8	
		Standard	
		Slow	
	Preset Speed	Fast	
		Slow	
		Middle	
	Joystick Pan Dir	Positive	
		Negative	
Joystick Tilt Dir	Positive		
	Negative		
Video Format	1080P60		
	1080P50		
	1080I60		
	1080I50		
	1080P30		

Main Menu	Sub Menu	Options	Sub-options
	1080P25 720P60 720P50 1080P59.94 1080I59.94 1080P29.97 720P59.94		
Version	MCU Version Camera Version AF version		
Restore Default	Restore Default (Yes/No)		

5.3 Professional Jargon Explanations of the OSD Menu

There are some professional jargons or nouns which are shown in the OSD menu of the PTC-140NDI camera, please refer to this section for realizing those jargons.

- **Speed by Zoom:** When this function is turned “ON”, at the time when the zoom-in/zoom out is beginning or it is about to reach the zoom-in/zoom-out limit or users want to stop zooming in/zooming out, the zoom-in/zoom-out speed of the camera lens will be reduced linearly. When this function is turned “OFF”, the zoom-in/zoom-out speed will be consistent no matter when the camera zoom-in is started or stopped.
- **Joystick Pan Dir:** Because the PTC-140NDI can use the upside down installation, if this option is set as “Positive”, the PTZ camera lens moving direction will be consistent to the direction which is selection by the remote controller. If this option is set as “Negative”, the PTZ camera lens moving direction will be reverse to the direction which is selected by the remote controller.
- **Joystick Tilt Dir :** Because the PTC-140NDI can use the upside down installation, if this option is set as “Positive”, the PTZ camera lens moving direction will be consistent to the direction which is selection by the remote controller. If this option is set as “Negative”, the PTZ camera lens moving direction will be reverse to the direction which is selected by the remote controller.
- **Flip-H:** This is the “Horizontal Flipping”. When “ON” is selected, the screen which is shot by the camera will flip horizontally. If “OFF” is selected, the screen will be shown in normal direction.
- **Flip-V:** This is the “Vertical Flipping”. When “ON” is selected, the screen which is shot by the camera will flip vertically. If “OFF” is selected, the screen will be shown in normal direction.

6. Installation Instructions

Note: Only mount the bracket on formwork or concrete surface. Do NOT mount the bracket on plasterboard.

In your product package, you should find

- PA4*30 self-tapping screw x 4
- PA4 plastic screw stopper x 4
- PM3*5 screw x 6
- Ceiling bracket (upper and lower plates) x 1
- PTC-140NDI camera x 1



PA4*30 Self-tapping Screw x 4



PA4 Plastic Screw Stopper x 4



PM3*5 Screw x 6



Ceiling Bracket (Upper and Lower Plates)

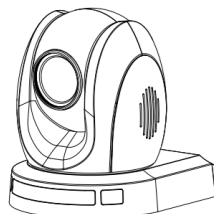

PTC-140T Camera

Step 1: The Ceiling Bracket

Separate the ceiling bracket into two parts (upper and lower plates) as depicted in the diagram below.

STEP 1

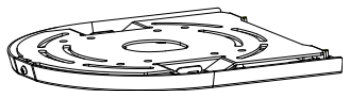

Ceiling Bracket

Upper Plate

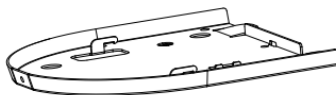

Lower Plate

Step 2: Mount the bracket's upper plate to the ceiling

Insert the four PA4 plastic screw stoppers into the ceiling as shown in the diagram below.

Using four PA4*30 self-tapping screws, affix the bracket's upper plate to the ceiling.

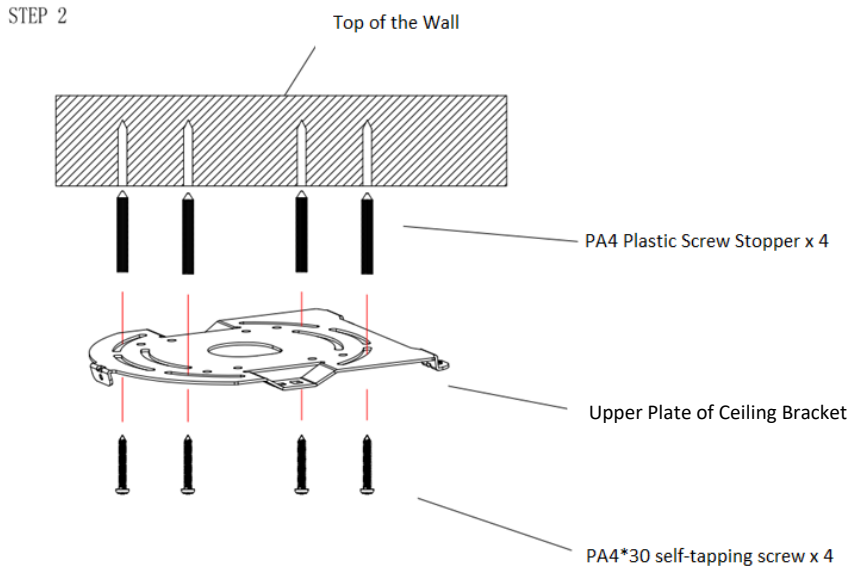

Step 3: Affix the bracket's lower plate to the bottom of PTC-140NDI

As depicted in the diagram below, use three PM3*5 screws to affix the bracket's lower plate to the bottom of PTC-140NDI.

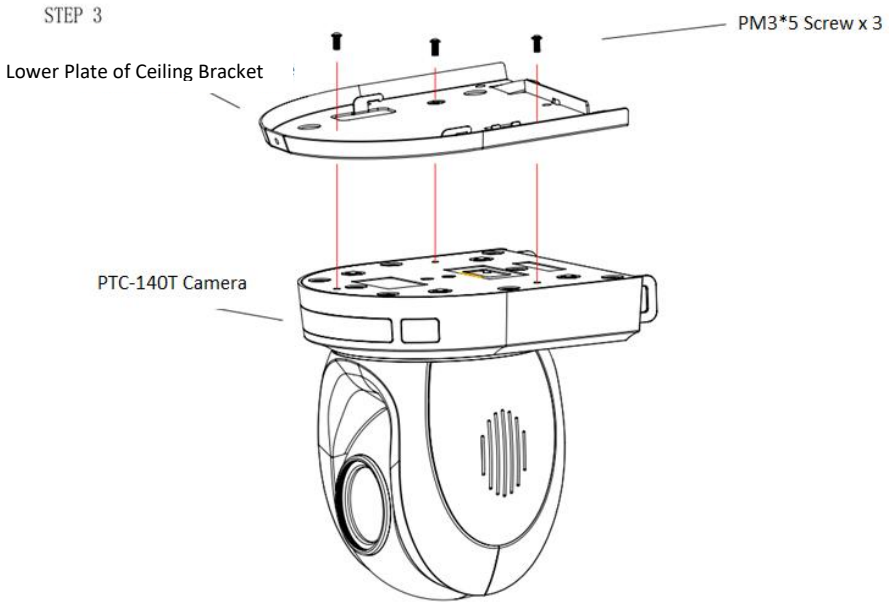

Step 4: Mount the PTC-140NDI Camera to the ceiling

Now push the PTC-140NDI camera into the bracket's upper plate in the direction as indicated by the arrow in the diagram below. Make sure the two plates click into place.

Finally, secure the PTC-140NDI camera to the upper plate with three PM3*5 screws.

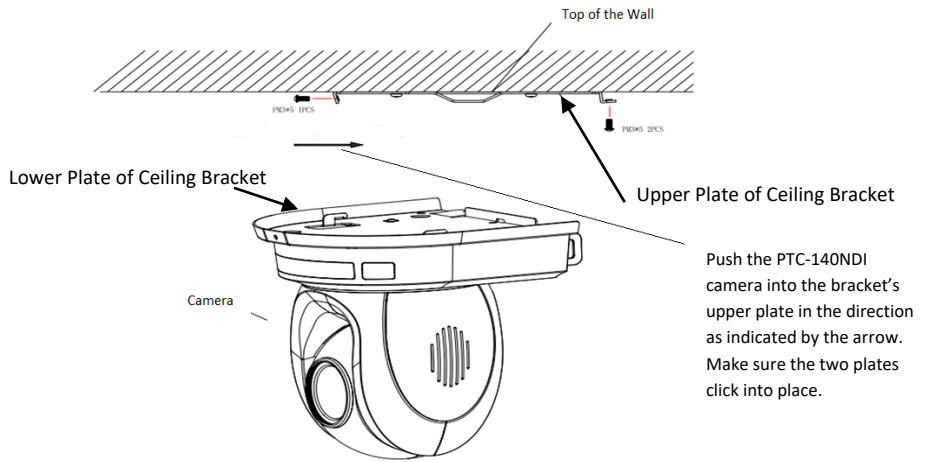

Step 5: Final

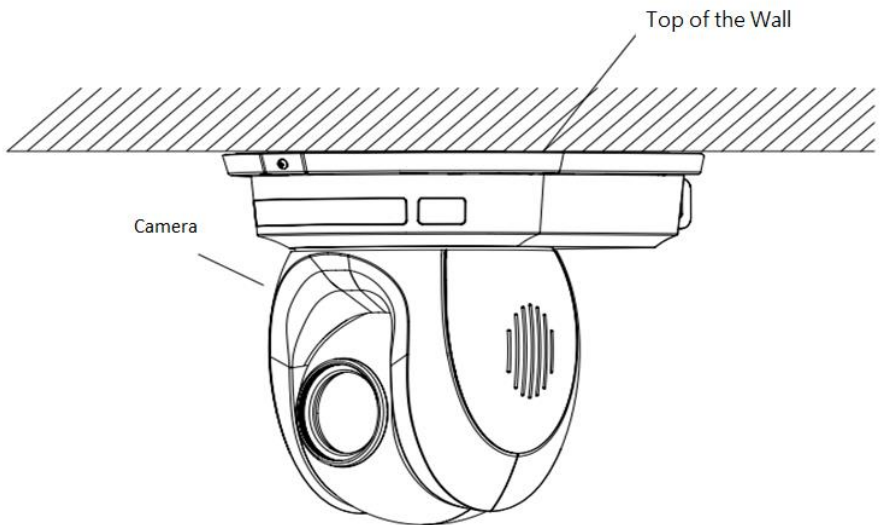

7. Network Connection

The Ethernet port on the back panel of your PTC-140NDI allows you to connect to camera from the PC/Laptop with Static or dynamic IP addresses. To access and modify these network settings, you will need to login to the camera's web interface.

If this is your first time using the device, please note that the camera's default IP address is **192.168.5.163**.

Set up direct connection between the camera and your PC/laptop as depicted in the diagram below; remember to manually assign an IP address of **192.168.5.X** to your PC/laptop.

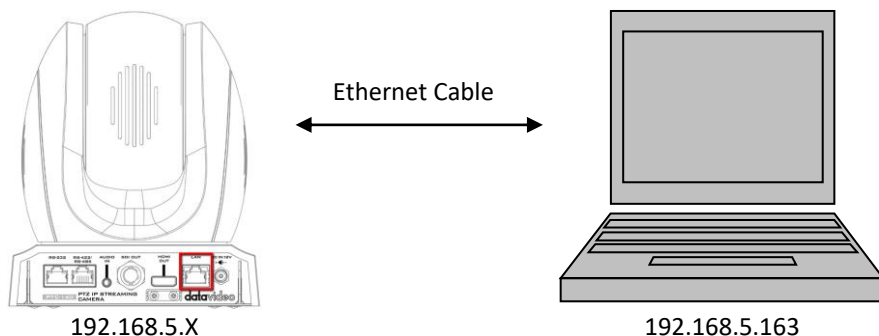

On your PC/laptop, open a web browser and in the address bar, enter the camera's default IP address, 192.168.5.163 then press the **ENTER** key which should take you to login page of the web interface.



The default login credentials are:

- User Name: admin
- Password: admin

After you have successfully login to the web interface, click “Configuration” → “Ethernet” to open the network settings page on which you should be able to see a list of options allowing you to set the camera’s connection mode to DHCP or static IP.

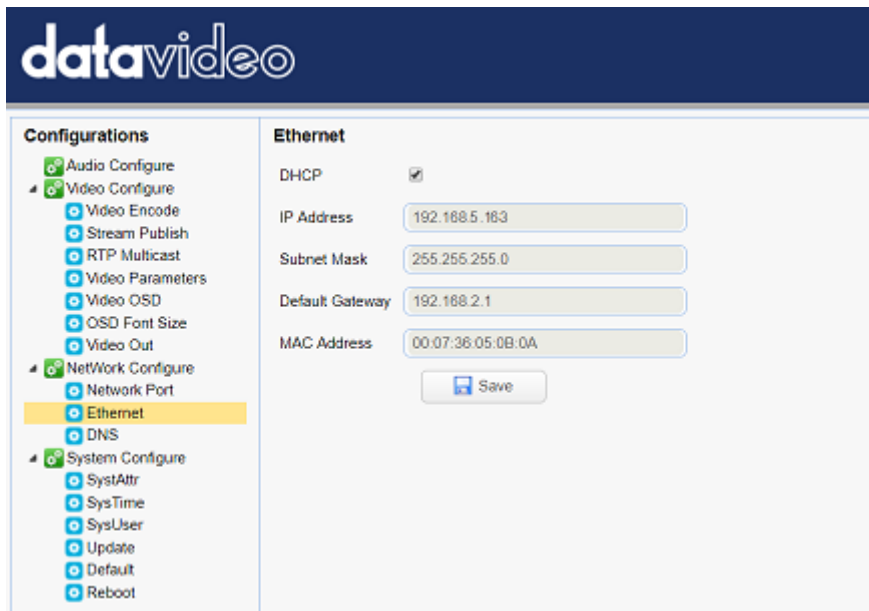

In this chapter, we will show you how to enable DHCP and Static IP modes on PTC-140NDI in two separate sections.

Note: To log out of the web interface, simply click “Logout” at the top right corner of the page.

7.1 DHCP Mode

Dynamic Host Configuration Protocol (DHCP) is a network protocol that enables a server to automatically assign an IP address to a network device from a defined range of numbers configured for a given network. The diagram below illustrates a DHCP network connection example.

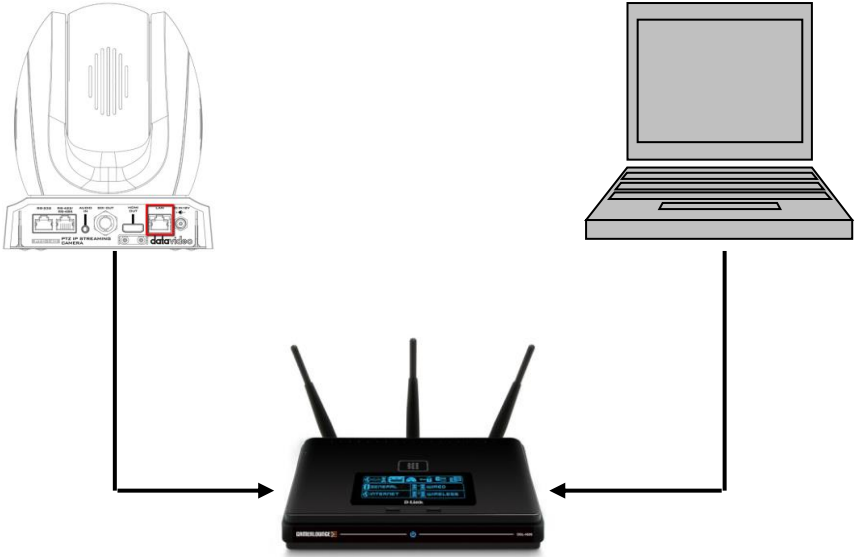

In order to enable the camera's DHCP mode, simply check the DHCP checkbox to allow the router to dynamically assign an IP address to PTC-140NDI.

Click **"Save"** button to save the new settings then reboot PTC-140NDI.

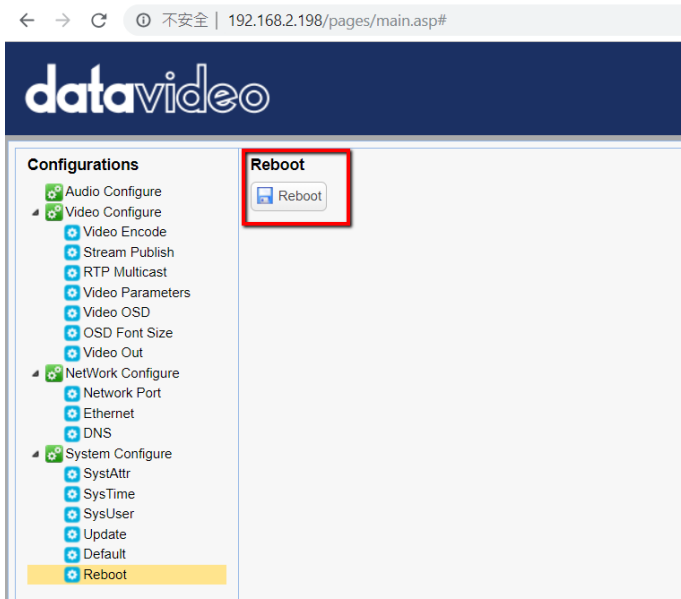

7.2 Static IP

A static IP address is a fixed address manually assigned to PTC-140NDI. First uncheck the DHCP checkbox then enter an IP address for the camera, the subnet mask and the gateway IP.

Note: Never assign an address that ends in .0 or .255 as these addresses are typically reserved for network protocols. An address to the very start of the IP pool is also not recommended as it is always reserved for the router.

After you've configured the camera's static IP, click "Save" button to save the new settings then reboot PTC-140NDI.

7.3 DVIP

DVIP is a special network configuration software tool designed for DVIP device search on the same network and configuring device network settings such as Hostname, DHCP mode, IP address, subnet mask, gateway IP, and primary and secondary DNS.

Depending on your operating system, download DVIP Configuration Tool from the respective sites listed as follows:

PC: <https://www.microsoft.com/en-us/p/dvip-network-config/9p6gtz839k6s?activetab=pivot%3Aoverviewtab>

Android:

https://play.google.com/store/apps/details?id=com.datavideo.dvipnetconfig&hl=en_US

iOS: <https://itunes.apple.com/tw/app/dvip-network-config/id1177895983?mt=8>

After you've installed the DVIP Network Configuration Tool, follow the steps outlined below to scan for online DVIP devices and configure their corresponding settings.

Step 1: Open the DVIP Network Configuration Tool and then select the connected Ethernet option from the “Network interface” pop-up window. After that please press the “OK” button.



Step 2: After the Network interface is selected, the DVIP Network Configuration Tool interface will be shown as following diagram.

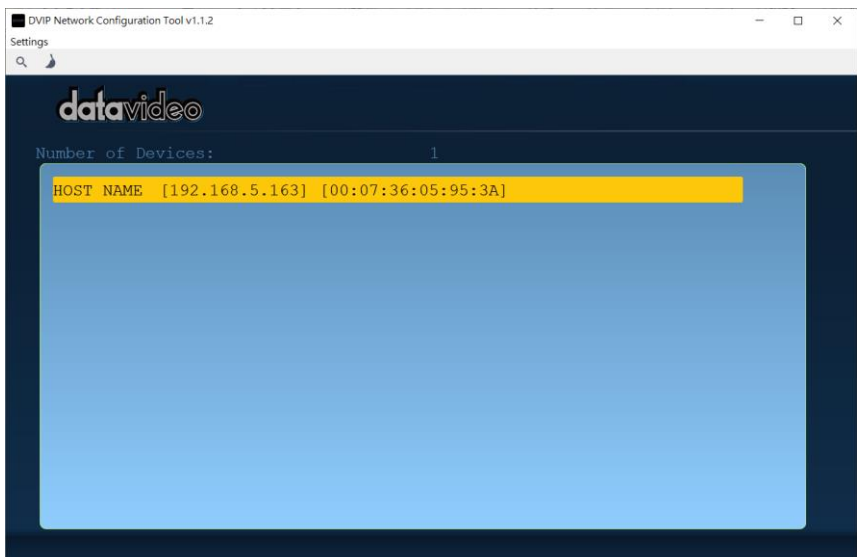

Step 3: Please press “HOST NAME” and then the network settings pop-up window will be shown.

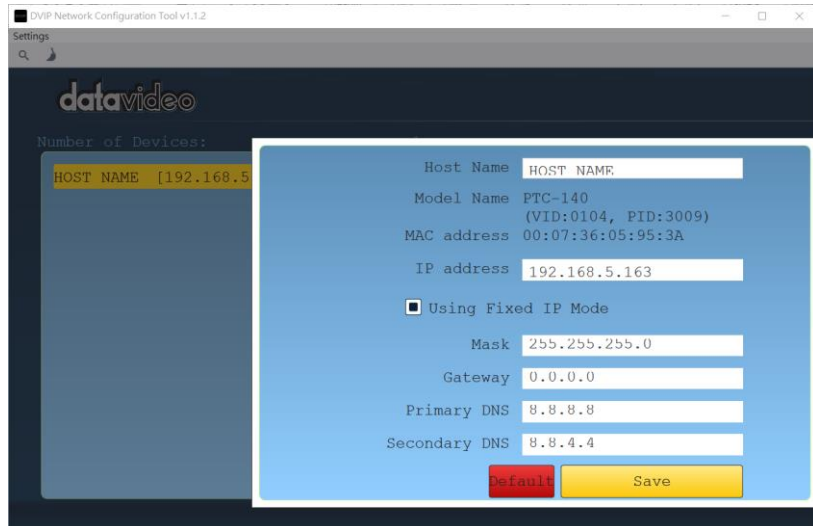
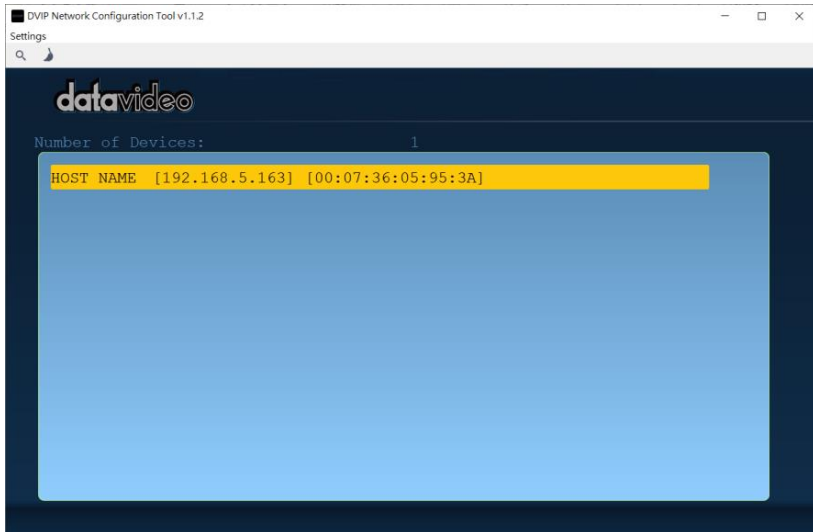

Step 4: users can click “Host Name” column for changing the device name. Users can also click each setting column for changing value if it is needed. After that, please press “Save” for saving those settings. Users can also press “Default” for resuming those settings to factory default value.

Host Name

Model Name PTC-140
(VID:0104, PID:3009)

MAC address 00:07:36:05:95:3A

IP address

Using Fixed IP Mode

Mask

Gateway

Primary DNS

Secondary DNS

8. Web User Interface

The web based user interface allows you to set and control your PTC-140NDI devices.

8.1 Preview

In preview, you will be able to see the camera image in real time as shown in the diagram below. Click on the preview window once to view in full screen mode and click again to exit.

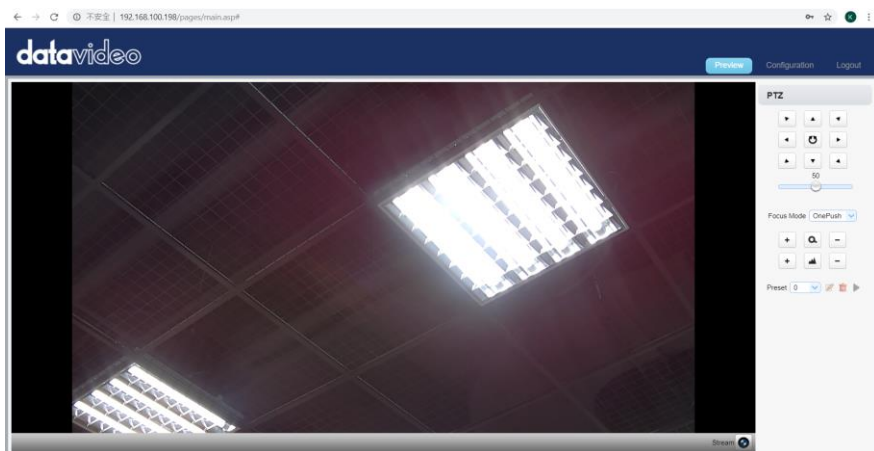







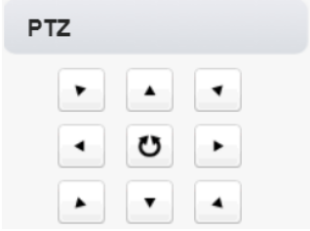

At the bottom right corner of the camera image display window, click the “Stream” button to switch between Main Stream and Sub Stream previews. See **Video Encode** in **Configuration** tab for stream settings.

Note: If the preview screen does not show anything upon first time login, try installing Adobe Flash Player to solve this issue.

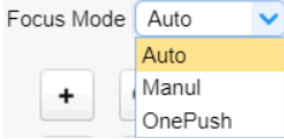





Control Functions

Further to the right, there are various control functions, such as **PTZ control**, **PTZ speed slider**, **focus mode** drop-down menu, **zoom** and **focus** controls, as well as **presets** for saving PTZ settings. Details of each will be described in the table below.

Controls	Descriptions
 <p>The image shows a control panel with a grey header labeled 'PTZ'. Below the header are nine square buttons arranged in a 3x3 grid. The top row contains three arrow buttons pointing right, up, and left. The middle row contains three arrow buttons pointing left, a circular refresh/home button, and an arrow button pointing right. The bottom row contains three arrow buttons pointing up, down, and left.</p>	<p>PTZ Control Buttons</p> <p>Click the arrow buttons to move the camera head to corresponding directions.</p> <p>To return to Home position, click .</p>
 <p>The image shows a horizontal slider control. The slider bar is light blue with a white circular knob in the center. Above the knob, the number '50' is displayed, indicating the current speed setting.</p>	<p>PTZ Speed Slider</p> <p>The PTZ speed slider adjusts the P/T speed, ranging from 0 (slowest) to 100 (fastest). The default speed is 50. Slide right to increase the speed and left to decrease.</p>
 <p>The image shows a 'Focus Mode' control. It features a drop-down menu with 'Auto' selected and a '+' button to its left. The drop-down menu is open, showing three options: 'Auto' (highlighted in yellow), 'Manul', and 'OnePush'.</p>	<p>Focus Mode</p> <p>Select focus mode from the drop-down menu; available options are Auto, Manual and One Push.</p> <p>Auto: Automatic focus Manual: Manual focus One Push: One time automatic focus.</p>
 <p>The image shows three square buttons in a row: a '+' button, a button with a mountain-like icon, and a '-' button.</p>	<p>Focus Far/Near</p> <p>Click  (FAR) and  (Near) buttons accordingly to manually focus the camera lens onto the subject.</p> <p>Note: You will not be able to manually adjust the camera focus if focus mode is set to Auto or One Push.</p>
 <p>The image shows three square buttons in a row: a '+' button, a magnifying glass icon, and a '-' button.</p>	<p>Zoom IN/OUT</p> <p>Click  to zoom in and  to zoom out.</p>

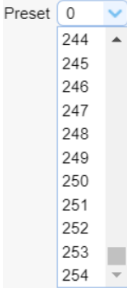
Preset

The presets allow you to save multiple PTZ settings to the camera. See function descriptions in the table below.

Functions	Descriptions
	Preset Drop-Down Menu Select a preset number from the drop-down menu. Note: There are 255 presets ranging from 0 – 254.
	Set Button Click Set button to save PTZ settings to the selected preset number.
	Delete Button Click Clear button to remove PTZ settings from the selected preset number.
	Run Button Click Run button to recall PTZ settings from the selected preset number.

Set the Preset

To set the preset, follow the steps outlined below.

1. First adjust the camera head to the desired **pan** and **tilt** positions.
2. Make sure **zoom** and **focus** are adjusted as well.
3. Select a preset number from the **Preset** drop-down menu.
4. Click the Set button to save the PTZ settings to the selected preset number.

Recall the Preset

To recall a saved preset, simply select a preset number from the **Preset** drop-down menu then click the Run button to apply the saved settings.

8.2 Configuration

In **Configuration**, you will be able to configure the camera's audio, video, network and system settings which will be described further in the next few sections.

Audio Configure

Audio Configure allows you to configure the input audio source.

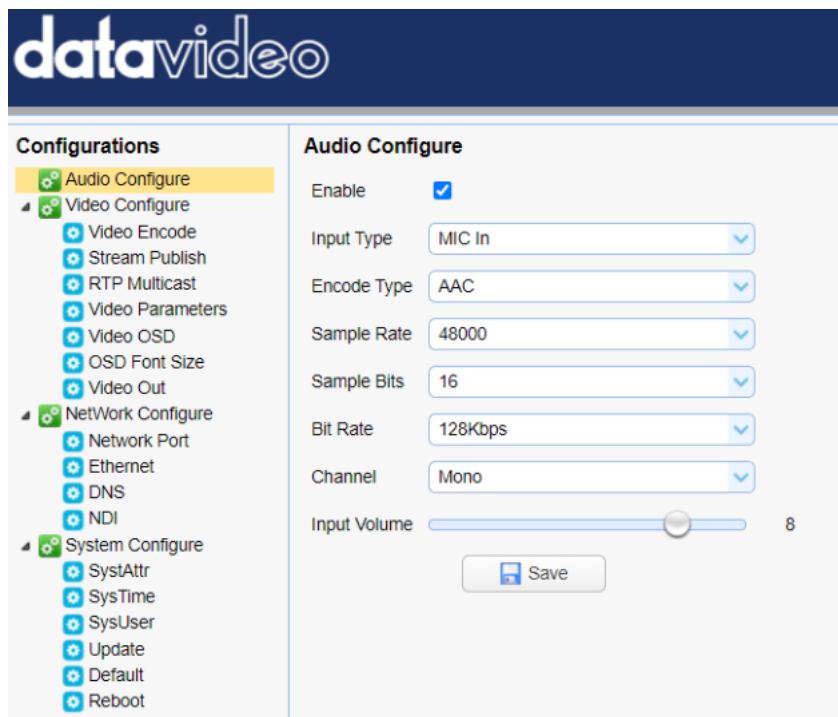

See the table below for descriptions of each item.

Items	Descriptions
<p>Enable <input checked="" type="checkbox"/></p>	<p>Enable Check this checkbox to enable audio settings.</p>
<p>Input Type <input type="text" value="Line In"/></p> <p>Encode Type <input type="text" value="Line In"/></p>	<p>Input Type This allows users to select the audio input type. It provides Line IN for the audio input type.</p>

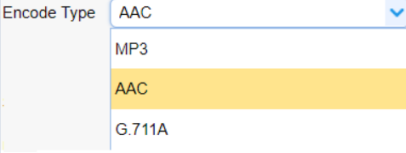
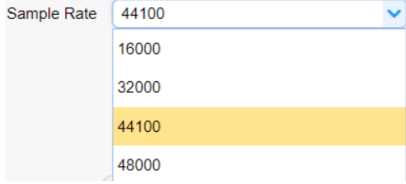
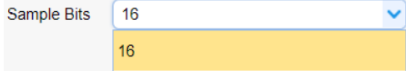
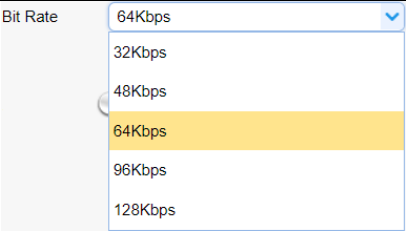
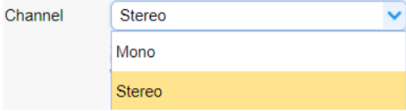
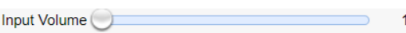
Items	Descriptions
	<p>Encode Type</p> <p>Select an encode type for your input audio source. The available encode types include MP3, AAC and G.711A.</p>
	<p>Sample Rate</p> <p>Select a sample rate for your input audio source. The higher the sample rate, the better the audio quality.</p>
	<p>Sample Bits</p> <p>Select the sample bits for your input audio source. The default is 16.</p>
	<p>Bit Rate</p> <p>Select a bit rate for your input audio source. Available bit rates are:</p> <ul style="list-style-type: none"> • 32 Kbps • 48 Kbps • 64 Kbps • 96 Kbps • 128 Kbps
	<p>Channel</p> <p>Set your input audio source to Mono or Stereo.</p>
	<p>Volume Slider</p> <p>Adjust the volume of your input audio source using the volume slider (Min: 1 / Max: 10).</p>

Items	Descriptions
 Save	Save Button Click the Save button to save the new audio settings.

Video Configure

Video Configure allows you to configure the input video source.

Video Encode

In **Video Encode**, you will be able to configure the video quality for main and sub streams. See the diagram below for various video settings.

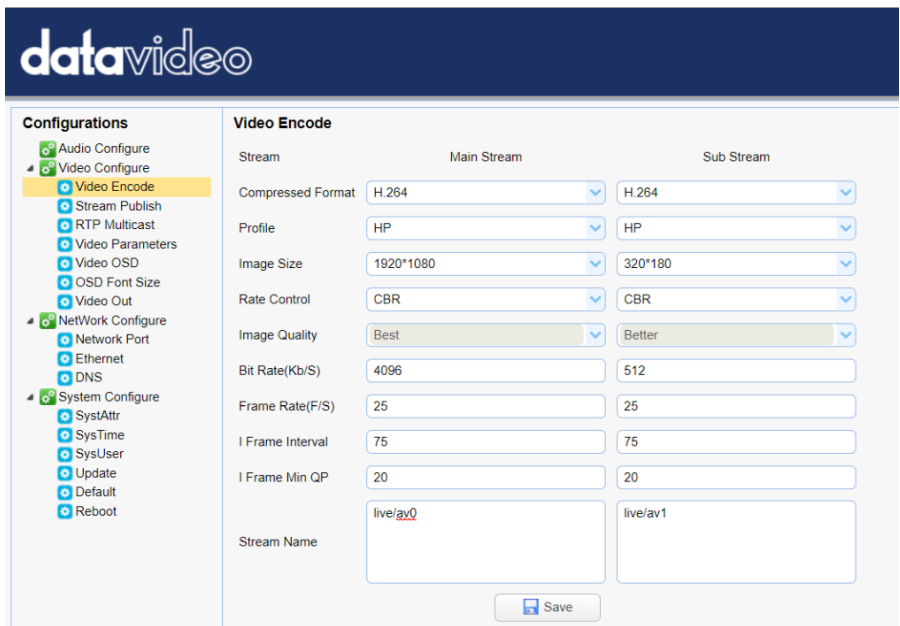

See the table below for descriptions of each item.

Items	Descriptions
Compressed Format <ul style="list-style-type: none"> H.264 <li style="background-color: yellow;">H.264 H.265 	Compressed Format Select either H.264 or H.265 video compression.

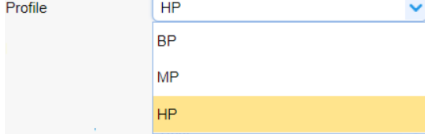
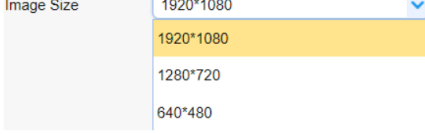
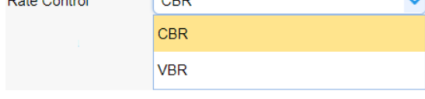
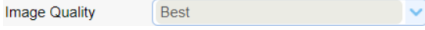
<p>Profile</p> 	<p>Profile</p> <p>Select a profile for your input video source. Available profiles are:</p> <ul style="list-style-type: none"> • BP: Baseline Profile (Default) • MP: Main Profile • HP: High Profile.
<p>Image Size</p> 	<p>Image Size</p> <p>Select an appropriate image size from the drop-down menu.</p> <ul style="list-style-type: none"> • 1920 x 1080 • 1280 x 720 • 640 x 480
<p>Rate Control</p> 	<p>Rate Control</p> <p>CBR encoding does not optimize media files for quality but will save you storage space. VBR takes longer to encode but produces the most favorable results as the quality of the media file is superior.</p>
<p>Image Quality</p> 	<p>Image Quality</p> <p>The default image quality for the main stream is “Best.”</p> <p>The default image quality for the sub stream is “Better.”</p>

<p>Bit Rate(Kb/S) <input type="text" value="4096"/></p>	<p>Bit Rate A bitrate is the amount of data required to encode a single second of video. From a streaming perspective, the higher the bitrate, the higher the quality, and the more bandwidth it will require.</p> <p>The default bit rate for the main stream is “4096 Kb/s.”</p> <p>The default bit rate for the sub stream is “512 Kb/s.”</p>
<p>Frame Rate(F/S) <input type="text" value="25"/></p>	<p>Frame Rate Higher frame rate will result in smooth video viewing experience. The frame rate is 25 by default.</p>
<p>I Frame Interval <input type="text" value="75"/></p>	<p>I Frame Interval A shorter I Frame Interval results higher quality video but consumes more network bandwidth. On the other hand if longer I Frame Interval is set, less bandwidth will be required but it will result in lower video quality. I frame interval is 75 by default.</p>
<p>I Frame Min QP <input type="text" value="20"/></p>	<p>I Frame Min QP A low QP value means less compression but higher video quality. The default value is 20.</p>
<p>Stream Name <input type="text" value="live/av0"/></p>	<p>Stream Name Enter a stream name for the main and sub stream.</p>
<p></p>	<p>Save Button Click the Save button to save the new video settings.</p>

Stream Publish

In **Stream Publish**, you will be able to configure the RTMP settings for main and sub streams. See the diagram below for various RTMP settings.

The screenshot shows the 'datavideo' interface for configuring 'Stream Publish'. On the left is a 'Configurations' sidebar with options like Audio Configure, Video Configure, Video Encode, Stream Publish (highlighted), RTP Multicast, Video Parameters, Video OSD, OSD Font Size, Video Out, Network Configure, Network Port, Ethernet, DNS, System Configure, SysAttr, SysTime, SysUser, Update, Default, and Reboot. The main area is titled 'Stream Publish' and is split into 'Main Stream' and 'Sub Stream' columns. Each column has an 'Enable' checkbox (checked), a 'Protocol Type' dropdown (set to RTMP), a 'Host Address' text box, a 'Host Port' text box, a 'Stream Name' text box, a 'User Name' text box, and a 'Password' text box. A 'Save' button is located at the bottom right of the main area.

See the table below for descriptions of each item.

Items	Descriptions
<p>Enable <input checked="" type="checkbox"/></p>	<p>Enable Check this checkbox to enable RTMP stream.</p>
<p>Protol Type <input type="text" value="RTMP"/></p>	<p>Protocol Type By default the protocol type is RTMP.</p>
<p>Host Address <input type="text" value="rtmp://a.rtmp.youtube.com/live2"/></p>	<p>Host Address This is the RTMP Server URL provided by the video streaming providers. An example of the RTMP Server URL is provided.</p>

Items	Descriptions
<p>Stream Name <input type="text" value="live2/qwqd-5ejj-t73c-0y2g"/></p>	<p>Stream Name This is the RTMP Stream Name/Key provided by the video streaming providers. An example of the RTMP Stream Name/Key is provided.</p>
<p>Host Port <input type="text" value="1935"/></p>	<p>Host Port The host port number is 1935 by default.</p>
<p>User Name <input type="text"/></p> <p>Password <input type="text"/></p>	<p>User Name / Password Enter the login credentials of your live streaming platform.</p>
<p></p>	<p>Save Button Click the Save button to save the new RTMP settings.</p>

Stream to Youtube

In this section, we will show you how to set up an **RTMP(S)** stream to **Youtube**. The step-by-step setup is outlined as follows:

1. First of all, you have to obtain Server URL and Stream Name/Key from Youtube.
2. Open the Youtube Live Dashboard
https://www.youtube.com/live_dashboard
3. On the left column, locate and click “**Stream now.**”

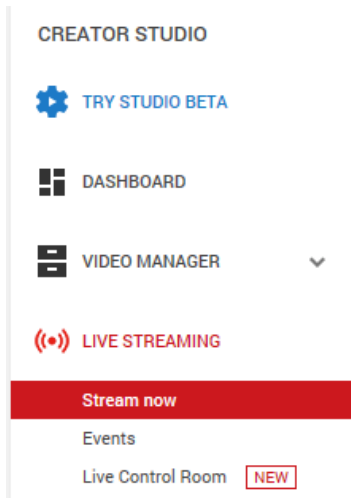

4. On the right, scroll down to the bottom where you will be able to find **Server URL** and **Stream name/key**.

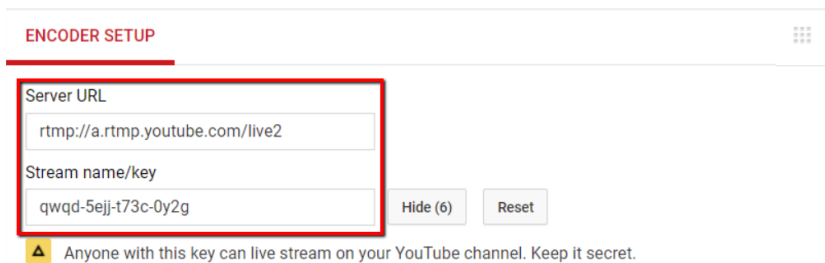

5. Open the PTC-140NDI's web UI and click "**Video Configure**" → "**Stream Publish.**"

Configurations	Stream Publish	
	Stream	Sub Stream
<ul style="list-style-type: none"> Audio Configure Video Configure Video Encode Stream Publish RTP Multicast Video Parameters Video OSD OSD Font Size Video Out NetWork Configure Network Port Ethernet DNS System Configure SystAttr SysTime SysUser Update Default Reboot 	<p>Enable <input checked="" type="checkbox"/></p> <p>Protocol Type: <input type="text" value="RTMP"/></p> <p>Host Address: <input type="text" value="a.rtmp.youtube.com"/></p> <p>Host Port: <input type="text" value="1935"/></p> <p>Stream Name: <input type="text" value="live2/qwqd-5ejj-t73c-0y2g"/></p> <p>User Name: <input type="text"/></p> <p>Password: <input type="password" value="****"/></p>	<p>Enable <input checked="" type="checkbox"/></p> <p>Protocol Type: <input type="text" value="RTMP"/></p> <p>Host Address: <input type="text" value="192.168.5.11"/></p> <p>Host Port: <input type="text" value="1935"/></p> <p>Stream Name: <input type="text" value="live/lav1"/></p> <p>User Name: <input type="text" value="admin"/></p> <p>Password: <input type="password"/></p>

6. Enter the **Server URL** and **Stream Name/Key** into **Host Address** and **Stream Name** respectively.
7. Check the **Enable** checkbox to enable RTMP stream.
8. Click the **Save** button to save the RTMP settings and start broadcasting your camera video on Youtube.

Stream to Facebook

- **Use Facebook Live Producer for Streaming**

1. Go to Facebook Live website

<https://www.facebook.com/formedia/solutions/facebook-live>, and then click “**Live Producer**” or “[facebook.com/live/producer](https://www.facebook.com/live/producer)” links from “How to go live on Facebook with a camera and streaming software” section.

Note: Facebook Live limits each stream to 8 hours.

Facebook Live How to Go Live Tools & Features Raise Money for a Cause Broadcast with Guests Online Events Grow & Earn Money Our Streaming Partners

How to go live on Facebook with a camera and streaming software

Utilize a streaming software.

You'll first need to get set up with streaming software, also referred to as encoding software or an encoder. The encoder that's best for you may depend on the type of content you plan to stream. There are several programs to choose from, including free open-source software. Learn more about encoding software options and going live with streaming software.

Use Live Producer.

Once you have your encoding software and camera installed, you're ready to go live using **Live Producer**, which is the new way to go live on Facebook using higher-end production equipment and streaming software. You can access **Live Producer** at facebook.com/live/producer.

Learn more about going live.

Learn more about how to use Live Producer here. If you're planning a larger virtual event or show, we also recommend checking out



2. Check **“Use stream key”** then copy and paste **“Server URL”** and **Stream Key** into **“Host Address”** and **“Stream Name”** as shown on the PTC-140NDI’s web UI respectively. Please modify the **“Host Port”** to 443.

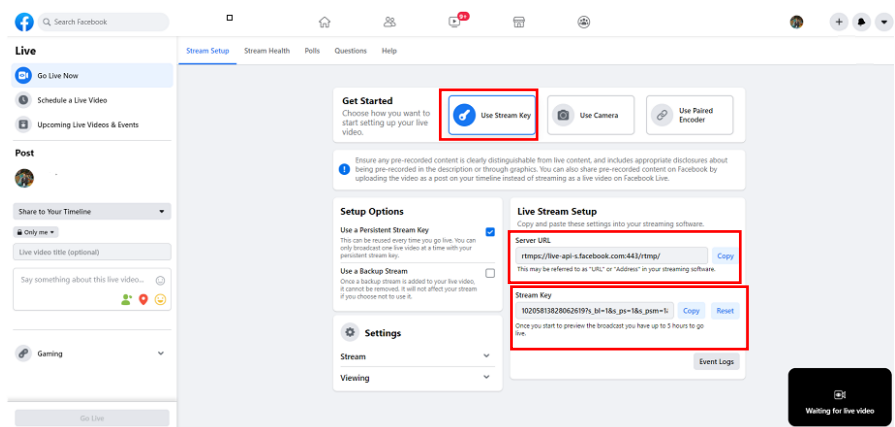

The screenshot shows the Facebook Live Stream Setup interface. Key elements include:

- Get Started** section with a red box around the **Use Stream Key** button.
- Setup Options** section where the **Use a Persistent Stream Key** checkbox is checked.
- Live Stream Setup** section with a red box around the **Server URL** field containing `rtmps://live-api-6.facebook.com/443/?rtmp/` and a **Copy** button.
- Stream Key** field containing `102058138220621979_b1=1&_ps=1&_psm=1` with **Copy** and **Reset** buttons.

3. Check the **Enable** checkbox to enable RTMP stream.
4. Click the **Save** button to save the RTMP settings.
5. Please press the **“Reboot”** button  from the Reboot option from the PTC-140NDI Web UI.

- The preview screen will be shown on the bottom-right corner of the Facebook Live page. Please select where you want to post your live-streaming and who can see your live-streaming. After that, please enter the title of the live-streaming and then please click “Go Live” button for live-streaming the video which is shot by the camera to the Facebook page.

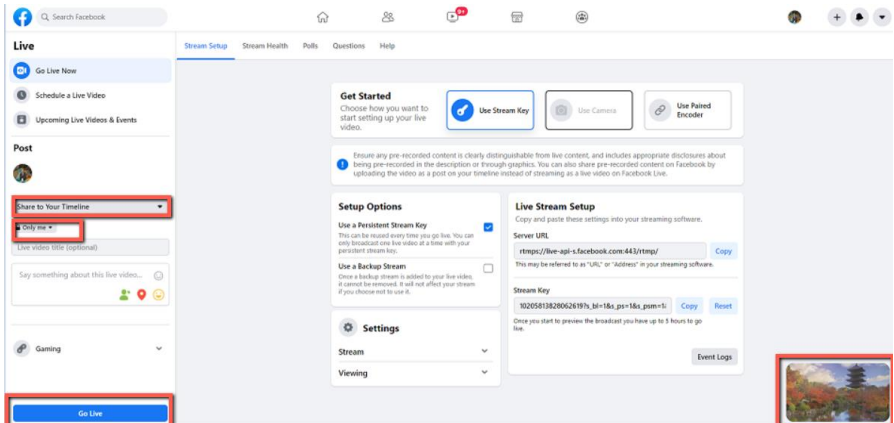

- After the live-streaming is started, users can see related information for the live-streaming video from the Facebook Live interface. If you want to stop the live-streaming, please click the “End Live Video” button for stopping your Facebook live-streaming.

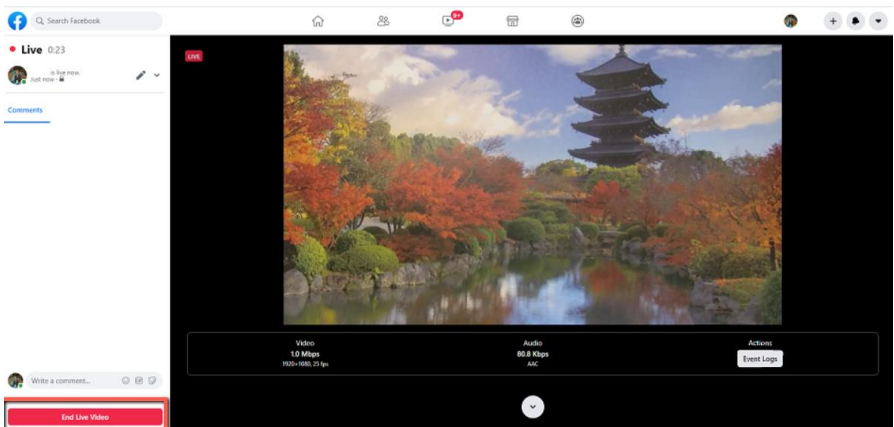

● Use your personal Facebook Page or Facebook Fan Page for Live-Streaming

1. Please press “Live Video” button from your personal Facebook Page or the Facebook Fan Page.

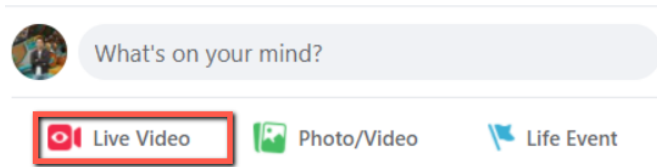

2. Check “Use stream key” then copy and paste “Server URL” and “Stream Key” into “Host Address” and “Stream Name” as shown on the PTC-140NDI’s web UI respectively. Please modify the “Host Port” to 443.

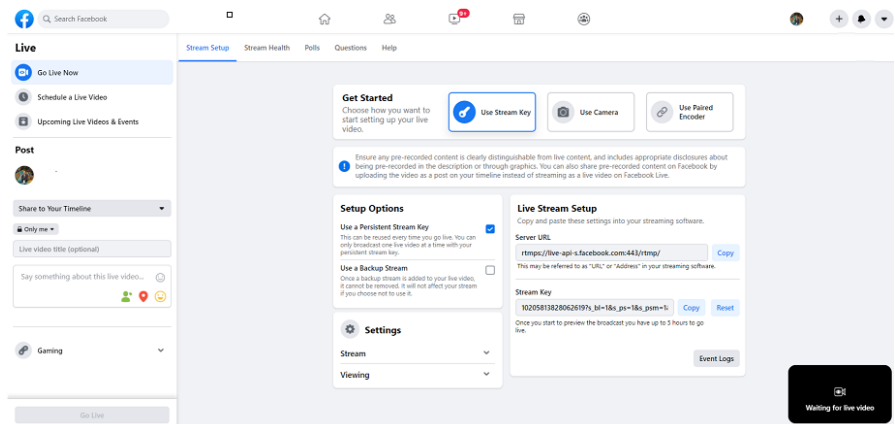

3. Check the **Enable** checkbox to enable RTMP stream.

4. Click the **Save** button to save the RTMP settings.

5. Please press the “Reboot” button  from the Reboot option from the PTC-140NDI Web UI.

6. The preview screen will be shown on the bottom-right corner of the Facebook Live page. Please select where you want to post your live-streaming and who can see your live-streaming. After that, please enter the title of the live-streaming and then please click “Go Live” button for live-streaming the video which is shot by the camera to the Facebook page.

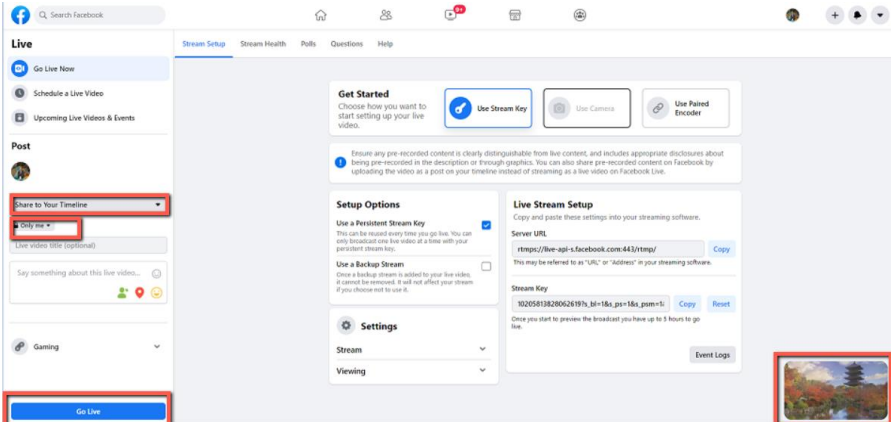

- After the live-streaming is started, users can see related information for the live-streaming video from the Facebook Live interface. If you want to stop the live-streaming, please click the “End Live Video” button for stopping your Facebook live-streaming.

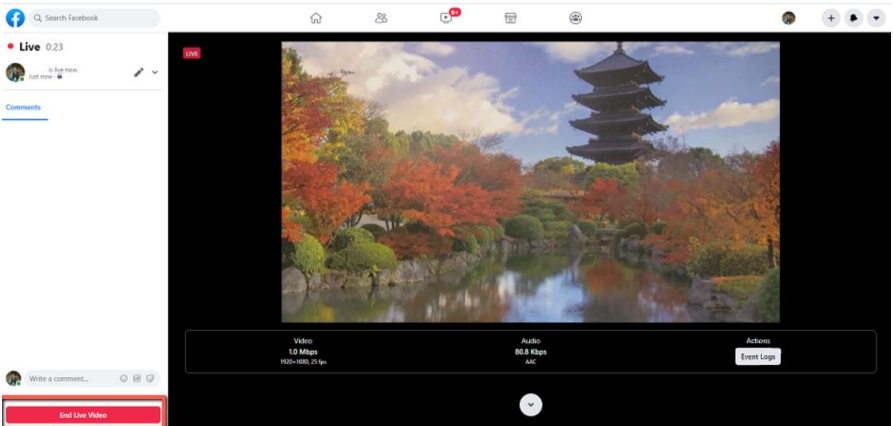

RTP Multicast

The RTP Multicast allows you to view camera video on certain video players such as VLC media player from a remote location.

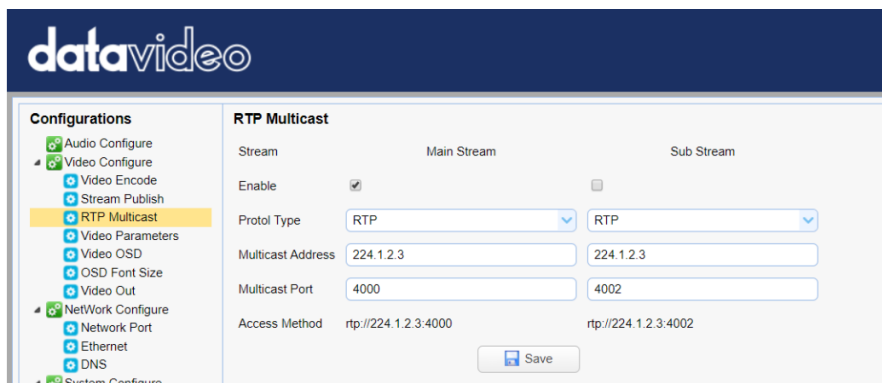

The screenshot shows the DataVideo web interface. On the left is a navigation menu under 'Configurations' with options: Audio Configure, Video Configure (expanded), Video Encode, Stream Publish, RTP Multicast (highlighted), Video Parameters, Video OSD, OSD Font Size, Video Out, NetWork Configure (expanded), Network Port, Ethernet, DNS, and System Configure. The main area is titled 'RTP Multicast' and is split into two columns: 'Main Stream' and 'Sub Stream'. The 'Main Stream' settings are: Enable (checked), Protocol Type (RTP), Multicast Address (224.1.2.3), Multicast Port (4000), and Access Method (rtp://224.1.2.3:4000). The 'Sub Stream' settings are: Enable (unchecked), Protocol Type (RTP), Multicast Address (224.1.2.3), Multicast Port (4002), and Access Method (rtp://224.1.2.3:4002). A 'Save' button is at the bottom right.

Follow the steps outlined below to view the camera video on VLC media player.

1. Download VLC media player from the link <https://www.videolan.org>.
2. Open VLC, click "Media" → "Open Network Stream" then enter rtp://224.1.2.3:4000 to view the main stream and rtp://224.1.2.3:4002 to view the sub stream.

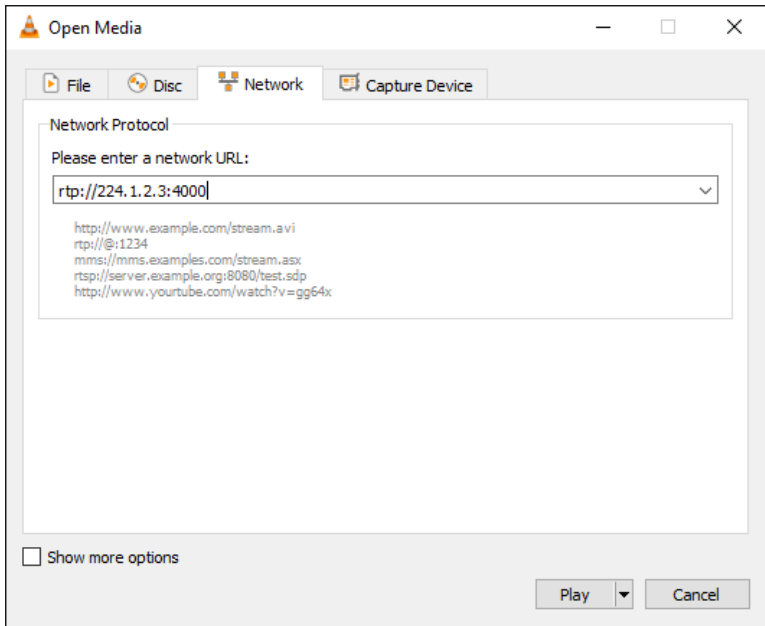

3. Click the **“Play”** button to start viewing the video stream.

You can also choose to stream over TS protocol. Follow the steps outlined below to view the camera video on VLC media player over TS protocol.

1. On **RTP Multicast** page of the PTC-140NDI’s web interface, select **“TS”** from the Protocol Type drop-down menu.

RTP Multicast		
Stream	Main Stream	Sub Stream
Enable	<input type="checkbox"/>	<input type="checkbox"/>
Protol Type	TS	RTP
Multicast Address	224.1.2.3	224.1.2.3
Multicast Port	4000	4002
Access Method	udp://@224.1.2.3:4000	rtp://224.1.2.3:4002
<input type="button" value="Save"/>		

2. Open VLC media player, click **“Media”** → **“Open Network Stream”** then enter `udp://@224.1.2.3:4000` to view the main stream and `udp://@224.1.2.3:4002` to view the sub stream.

3. Click the “**Play**” button to start viewing the video stream.

Video Parameters

This sets the camera focus, exposure, color balance, image settings, noise reduction and picture styles.

Focus

In **Focus**, you are allowed to set **Focus Mode**, **Auto Focus Zone** and **Auto Focus Sensitivity**.

Configurations

- Audio Configure
- Video Configure
 - Video Encode
 - Stream Publish
 - RTP Multicast
 - Video Parameters**
 - Video OSD
 - OSD Font Size
 - Video Out
- NetWork Configure
 - Network Port
 - Ethernet
 - DNS
- System Configure
 - SysAttr
 - SysTime
 - SysUser
 - Update
 - Default
 - Reboot

Video Param

Focus | Exposure | Color | Image | NR | Style | Refresh

Focus Mode: Auto

AF-Zone: Center

AF-Sensitivity: Low

*Click the "Refresh" button to refresh parameter.

*Effective after changed parameters

- Focus Mode: Available modes are **Auto**, **Manual** and **One Push**.
- AF-Zone: This sets auto focus zone by selecting **Top**, **Center**, **Bottom** or **All** from the drop-down menu.
- AF-Sensitivity: This sets auto focus sensitivity by selecting High, Middle and Low from the drop-down menu.

Exposure

In **Exposure**, you are allowed to set Exposure Mode, Exposure Value (EV), Backlight Compensation (BLC), Anti-Flicker, Gain Limit and Dynamic Range Compression (DRC).

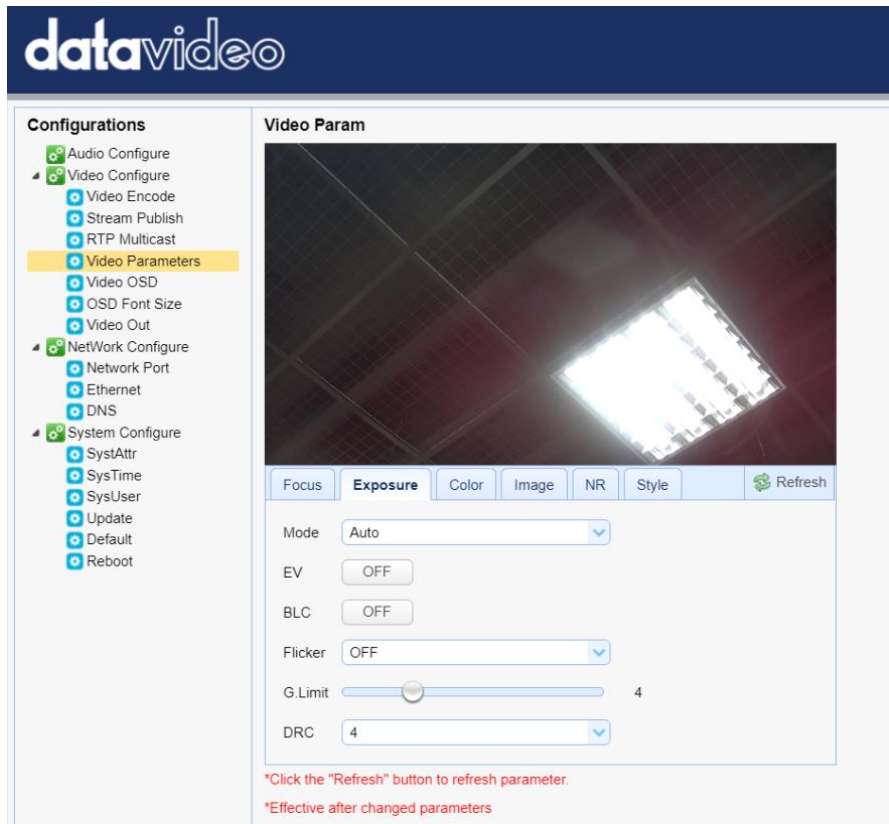

The screenshot displays the DataVideo web interface. On the left, a 'Configurations' sidebar lists various settings: Audio Configure, Video Configure (with sub-items: Video Encode, Stream Publish, RTP Multicast, Video Parameters, Video OSD, OSD Font Size, Video Out), NetWork Configure (with sub-items: Network Port, Ethernet, DNS), and System Configure (with sub-items: SystAttr, SysTime, SysUser, Update, Default, Reboot). The 'Video Param' section is active, showing a video preview of a ceiling light fixture. Below the preview are tabs for Focus, Exposure, Color, Image, NR, Style, and a Refresh button. The Exposure settings are: Mode (Auto), EV (OFF), BLC (OFF), Flicker (OFF), G.Limit (4), and DRC (4). A red note at the bottom states: '*Click the "Refresh" button to refresh parameter. *Effective after changed parameters'.

- **Mode:** Available focus modes are **Auto**, **Manual**, **SAE (Shutter Automatic Exposure)**, **AAE (Aperture Automatic Exposure)** and **Bright**.

Auto – Fully automatic settings for shutter speed and aperture with ability to adjust gain, dynamic range, backlight and anti-flicker.

Manual – Full iris, shutter speed and range control

Shutter Automatic Exposure – The camera will measure light and automatically set the aperture based on your desired shutter speed.

Aperture Automatic Exposure – The camera will measure light and automatically set the shutter speed based on your desired iris opening (aperture).

- EV: **EV** is exposure value. By turning it ON, an EV slider will appear for adjusting the exposure value.
- BLC: By turning the **backlight compensation**, the camera will compensate for backlight by enhancing automatic exposure control on the camera.
- Flicker: To avoid video flicker, you can set your camera flicker frequency to **50Hz** or **60Hz**.
- Gain Limit Slider: Select gain limit from 0 to 15.
- DRC: Sets the amount of Dynamic Range Compression where higher values lead to more compression (**1 – 8** or **off**).

Color

In **Color**, you are allowed to set color balance such as white balance, red gain fine tuning, blue gain fine tuning, saturation, hue and automatic white balance sensitivity. The color balance of your image will change the colors rendered in your image.

Configurations

- Audio Configure
- Video Configure
 - Video Encode
 - Stream Publish
 - RTP Multicast
 - Video Parameters
 - Video OSD
 - OSD Font Size
 - Video Out
- NetWork Configure
 - Network Port
 - Ethernet
 - DNS
- System Configure
 - SystAttr
 - SysTime
 - SysUser
 - Update
 - Default
 - Reboot

Video Param



Focus
Exposure
Color
Image
NR
Style
Refresh

WB Mode

RG Tuning

BG Tuning

Saturation

Hue

AWB Sensitivity

*Click the "Refresh" button to refresh parameter.
*Effective after changed parameters

- WB Mode: Select white balance mode from the options listed below.
 - Auto
 - Manual
 - One Push
 - VAR
 - 2400K
 - 2500K
 - 2600K
 - 2700K
 - 2800K
 - 2900K
 - 3000K
 - 3100K
 - 3200K
 - 3300K
 - 3400K

- 3500K
- 3600K
- 3700K
- 3800K
- 3900K
- 4000K
- 4100K
- 4200K
- 4300K
- 4400K
- 4500K
- 4600K
- 4700K
- 4800K
- 4900K
- 5000K
- 5100K
- 5200K
- 5300K
- 5400K
- 5500K
- 5600K
- 5700K
- 5800K
- 5900K
- 6000K
- 6100K
- 6200K
- 6300K
- 6400K
- 6500K
- 6600K
- 6700K
- 6800K
- 6900K
- 7000K
- 7100K

- **RG Tuning:** This fine tunes the red gain from **-10 to 10** but effective only in **AUTO** mode.
- **BG Tuning:** This fine tunes the blue gain from **-10 to 10** but effective only in **AUTO** mode.
- **Saturation: 60% to 200%.**
Note: The higher the saturation, the more vivid the colors will be.
- **Hue:** Chroma adjustment from **0 to 14**.
- **AWB Sensitivity:** This is the white balance sensitivity; select **Low, Middle** or **High**.

Image

Other image settings include brightness, contrast, sharpness, gamma, digital cinema, black and white, orientation, digital zoom and ultra-low illumination.

Configurations

- Audio Configure
- Video Configure
 - Video Encode
 - Stream Publish
 - RTP Multicast
 - Video Parameters**
 - Video OSD
 - OSD Font Size
 - Video Out
- NetWork Configure
 - Network Port
 - Ethernet
 - DNS
 - NDI
- System Configure
 - SysAttr
 - SysTime
 - SysUser
 - Update
 - Default
 - Reboot

Video Param

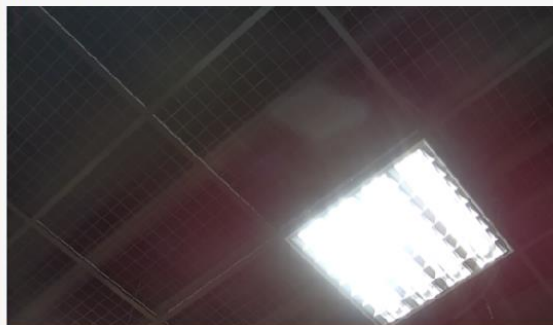

Focus	Exposure	Color	Image	NR	Style	Refresh
Bright	<input type="range"/>					7
Contrast	<input type="range"/>					7
Sharpness	<input type="range"/>					3
Gamma			Default			
DCI			OFF			
B&W Mode			Color			
Flip-H			OFF			
Flip-V			OFF			
DZoom			OFF			
Low-Light Mode			OFF			

*Click the "Refresh" button to refresh parameter.

*Effective after changed parameters

- Bright: Brightness level adjustment from **0 to 14**.
- Contrast: Contrast adjustment from **0 to 14**.
- Sharpness: Sharpness adjustment from **0 to 15**.
- Gamma: Selects a gamma value from the following
 - Default
 - 0.45
 - 0.50
 - 0.55
 - 0.63

- DCI: To enable DCI, simply select a value from **1 to 8**; selecting **OFF** will disable DCI.
- B&W Mode: This allows you to switch between color and black-and-white modes.
- Flip-H: Turning it ON flips the image along the horizontal axis.
- Flip-V: Turning in ON flips the image along the vertical axis.
- DZoom: This enables/disables digital zoom.
- Low-Light Mode: This enables/disables Low-Light Mode.

NR

Image noise is extremely distracting to viewers and enabling noise reduction will remove noise to achieve a broadcast quality image.

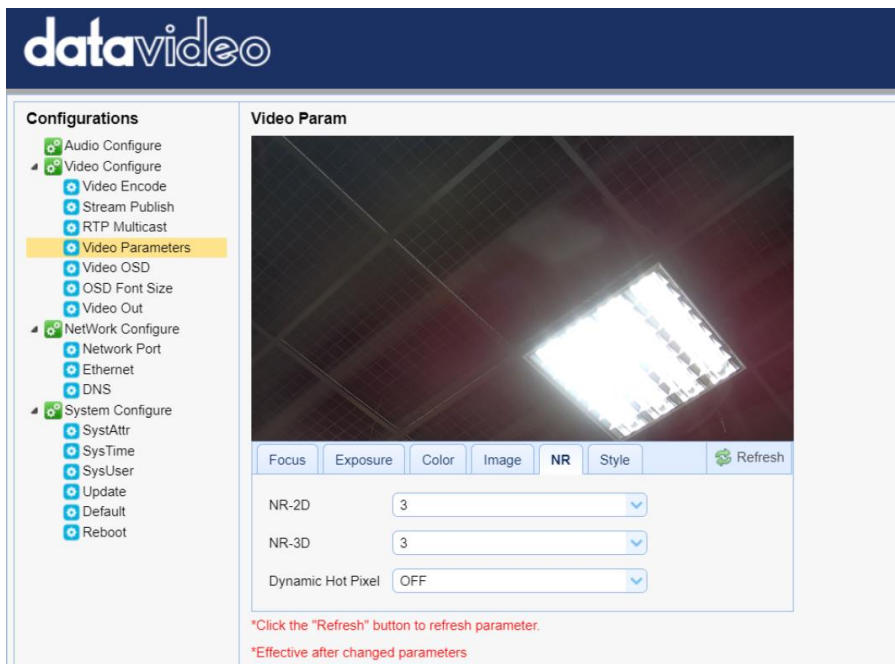

The screenshot shows the DataVideo web interface. On the left is a 'Configurations' sidebar with a tree view including Audio Configure, Video Configure (expanded), NetWork Configure, and System Configure. Under Video Configure, 'Video Parameters' is highlighted. The main area is titled 'Video Param' and contains a video preview window showing a ceiling light fixture. Below the preview are tabs for Focus, Exposure, Color, Image, NR (selected), and Style, along with a Refresh button. The NR configuration section includes three dropdown menus: NR-2D (set to 3), NR-3D (set to 3), and Dynamic Hot Pixel (set to OFF). Red text at the bottom of the interface reads: '*Click the "Refresh" button to refresh parameter.' and '*Effective after changed parameters'.

- NR-2D: 2D noise reduction is ideal for scenes with movement.
 - OFF
 - 1 – 7

- Auto
- NR-3D: 3D noise reduction is ideal for static fields of view.
 - OFF
 - 1 – 7

Note: By using both 2D and 3D noise reduction together, you can effectively enhance both moving and static imagery, which is ideal for most live broadcast environments.

- Dynamic Hot Pixel: Hot pixels are bright colored spots in your images, often noticeable with slow shutter speeds or high ISO settings. By enabling the dynamic hot pixel feature, these spots will be automatically removed.
 - OFF
 - 1 – 5

Style

In **Style**, you will be able to select the picture style of your preference. The available styles are:

- Default
- Normal
- Clarity
- Bright
- Soft

Configurations

- Audio Configure
- Video Configure
 - Video Encode
 - Stream Publish
 - RTP Multicast
 - Video Parameters**
 - Video OSD
 - OSD Font Size
 - Video Out
- NetWork Configure
 - Network Port
 - Ethernet
 - DNS
- System Configure
 - SystAttr
 - SysTime
 - SysUser
 - Update
 - Default
 - Reboot

Video Param

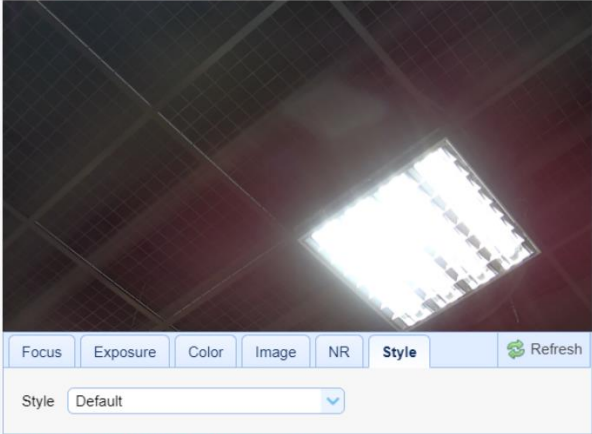

Focus Exposure Color Image NR **Style** Refresh

Style:

*Click the "Refresh" button to refresh parameter.
*Effective after changed parameters

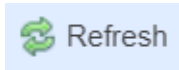

Note: Each time after you modify the camera parameters, please click the Refresh button to apply the new settings.

Video OSD

In **Video OSD**, you will be allowed to show video time and title on the screen. You can further set the font color as well as their positions.

Configurations

- Audio Configure
- Video Configure
 - Video Encode
 - Stream Publish
 - RTP Multicast
 - Video Parameters
 - Video OSD
 - OSD Font Size
 - Video Out
- NetWork Configure
 - Network Port
 - Ethernet
 - DNS
- System Configure
 - SystAttr
 - SysTime
 - SysUser
 - Update
 - Default
 - Reboot

Video OSD



Show Time

Show Title

Time Font Color

Title Font Color

OSD Offset Title Time

Enable Video Time and Title on Screen

Show Time

Show Title

Simply check the checkbox then click the **Save** button to display video time and title on the screen.

Set Font Color of Time and Title

You can also select a display color for your time and title. Available color options include:

- White
- Black
- Yellow
- Red
- Blue

Adjust Time and Title Positions



On the OSD Offset tile, you will be allowed to adjust positions of the Time and Title displayed on the screen. First select Time or Title then click the arrow buttons to move it to the desired position.

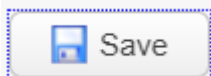

Note: After you've configured the video time and title, click the Save button to apply the new settings.

OSD Font Size

In **OSD Font Size**, you can set the font size for the Master and Slave streams by entering a number into the respective textboxes shown in the diagram below. In addition, you can also select to allow the system to scale the font size automatically according to the resolution set.

Configurations

- Audio Configure
- Video Configure
 - Video Encode
 - Stream Publish
 - RTP Multicast
 - Video Parameters
 - Video OSD
 - OSD Font Size**
 - Video Out
- NetWork Configure
 - Network Port
 - Ethernet
 - DNS
- System Configure

OSD Font Size

According to the resolution

Scale size automatically

Master Stream OSD Font Size

Slave Stream OSD Font Size

Video OUT

The **Video Out** allows users to select the desired video output resolution from the drop-down menu. Supported output resolutions include:

- 1080P60
- 1080P50
- 1080P30
- 1080P25
- 1080I60
- 1080I50
- 720P60
- 720P50
- 1080P59.94
- 1080I59.94
- 720P59.94
- 1080P29.97

Note: Click the **Save** button after you've selected a resolution.

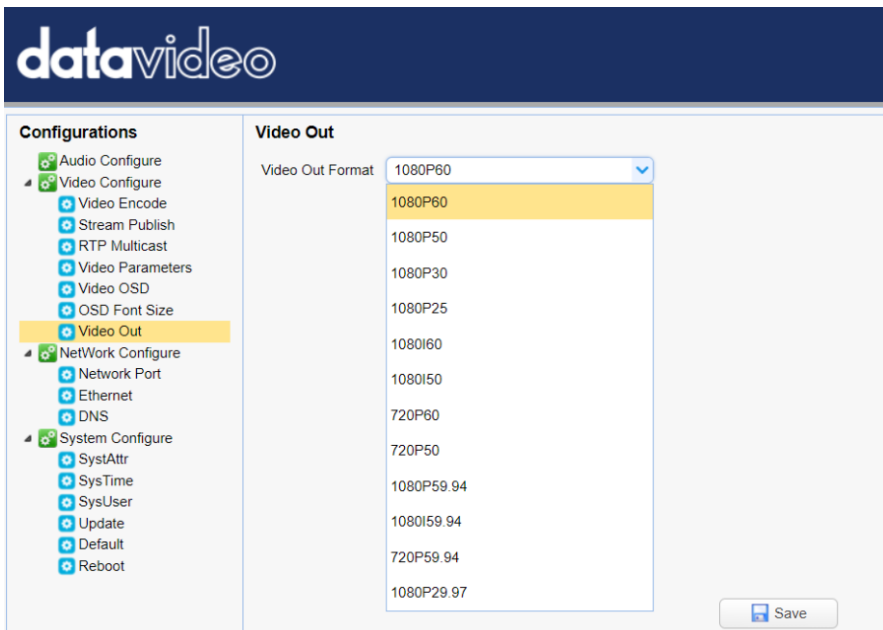

The screenshot shows the 'datavideo' web interface. On the left is a 'Configurations' sidebar with a tree view containing: Audio Configure, Video Configure (expanded), NetWork Configure, and System Configure. Under 'Video Configure', 'Video Out' is selected and highlighted in yellow. The main panel is titled 'Video Out' and features a 'Video Out Format' dropdown menu. The dropdown is open, showing a list of resolutions: 1080P60 (highlighted), 1080P50, 1080P30, 1080P25, 1080I60, 1080I50, 720P60, 720P50, 1080P59.94, 1080I59.94, 720P59.94, and 1080P29.97. A 'Save' button is located at the bottom right of the main panel.

Network Configure

Network Configure allows you to configure the network functions of your camera.

Network Port

In **Network Port**, you should be able to find a list of default port numbers for different data communication protocols. Please note that these port numbers may vary according to your network environment.

Note: Click the **Save** button after you've edited the port numbers.

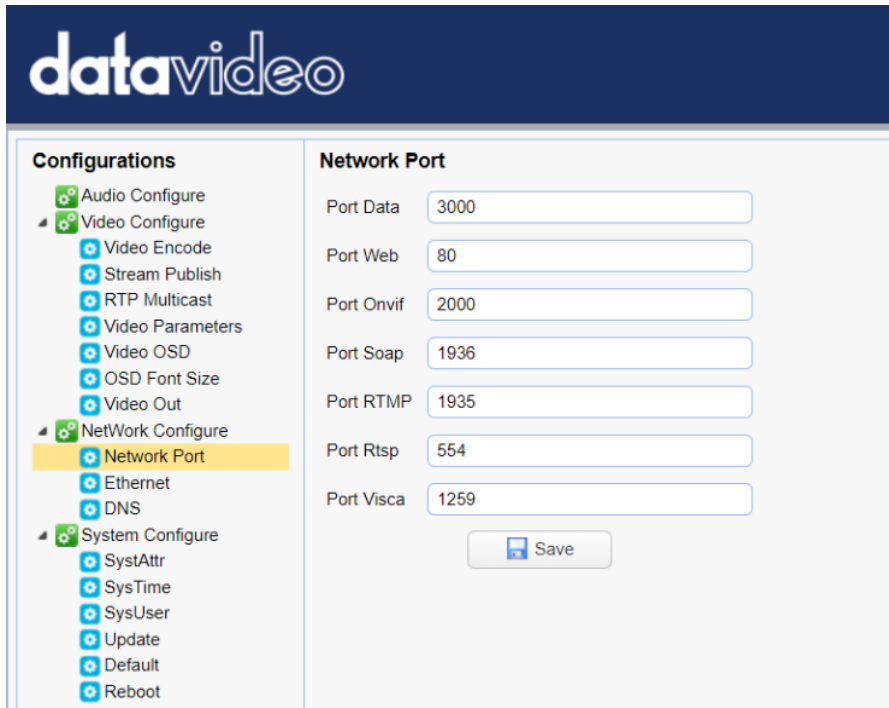

The screenshot shows the DataVideo web interface. On the left is a navigation menu under 'Configurations' with categories: Audio Configure, Video Configure (expanded), NetWork Configure (selected and highlighted), and System Configure. Under 'NetWork Configure', 'Network Port' is selected. The main area is titled 'Network Port' and contains a list of ports with input fields: Port Data (3000), Port Web (80), Port Onvif (2000), Port Soap (1936), Port RTMP (1935), Port Rtsp (554), and Port Visca (1259). A 'Save' button is at the bottom.

Port Name	Port Number
Port Data	3000
Port Web	80
Port Onvif	2000
Port Soap	1936
Port RTMP	1935
Port Rtsp	554
Port Visca	1259

Ethernet

In **Ethernet**, you are allowed to modify your network settings according to your network environment. For more details on **DHCP** and **Static IP Mode**, see [Network Connection](#).

Note: Click the **Save** button after you've edited the network settings.

Configurations

- Audio Configure
- Video Configure
 - Video Encode
 - Stream Publish
 - RTP Multicast
 - Video Parameters
 - Video OSD
 - OSD Font Size
 - Video Out
- NetWork Configure
 - Network Port
 - Ethernet**
 - DNS
- System Configure
 - SystAttr
 - SysTime
 - SysUser
 - Update
 - Default
 - Reboot

Ethernet

DHCP

IP Address

Subnet Mask

Default Gateway

MAC Address

DNS

In **DNS**, Enter the DNS information which is 8.8.8.8 by default.

Configurations

- Audio Configure
- Video Configure
 - Video Encode
 - Stream Publish
 - RTP Multicast
 - Video Parameters
 - Video OSD
 - OSD Font Size
 - Video Out
- NetWork Configure
 - Network Port
 - Ethernet
 - DNS**
- System Configure
 - SystAttr

DNS

Preferred DNS Server

Alternative DNS Server

System Configure

System Configure allows you to configure your camera system.

System Attribute

In System Attribute, you are allowed to edit your camera name and select the Web UI language. Available languages are **Traditional Chinese**, **Simplified Chinese** and **English**.

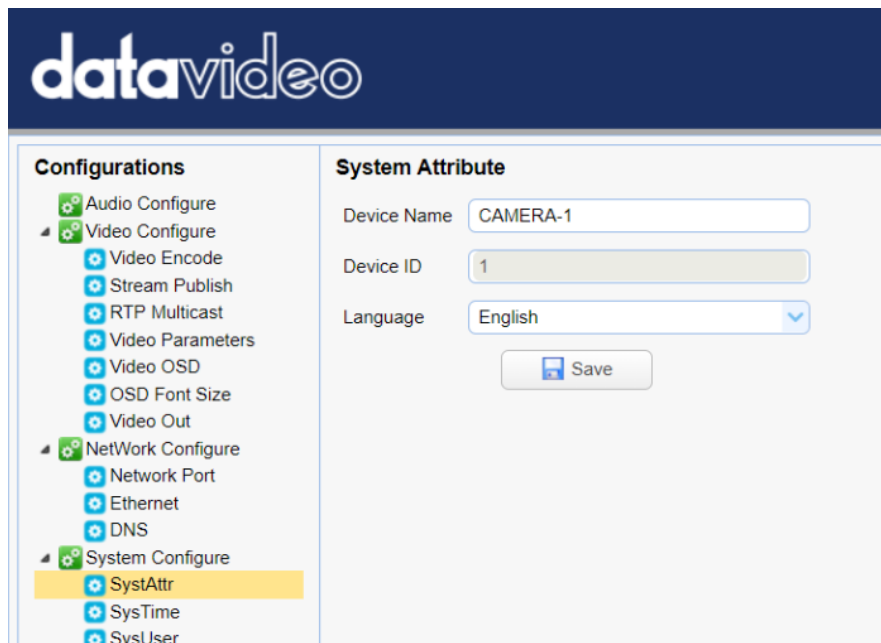

System Time

In **System Time**, you are allowed to set the **Date Format**, **Time Zone**, **Hour Type** and **NTP**.

NTP stands for Network Time Protocol and it is an Internet protocol used to synchronize the clocks of devices over a network to some time reference. Once NTP is enabled, you will be allowed to select the update frequency and assign the time server.

If NTP is not enabled, you may choose to synchronize the device time with the computer time.

Configurations

- Audio Configure
- Video Configure
 - Video Encode
 - Stream Publish
 - RTP Multicast
 - Video Parameters
 - Video OSD
 - OSD Font Size
 - Video Out
- NetWork Configure
 - Network Port
 - Ethernet
 - DNS
- System Configure
 - SystAttr
 - SysTime**
 - SysUser
 - Update
 - Default
 - Reboot

System Time

Date Format: YYYY-MM-DD

Date Sprtr: /

Zone: (GMT+08:00)Beijing, Hongkong, Sin

Hour Type: 24 Hours

NTP Enable:

Update Interval: 1 day

Host Url: time.nist.gov

Host Port: 123

Time Settings

Time Settings: Synchronize with computer time

Computer Time: 2019-02-22 10:47:04

System User

In **System User**, you are allowed to edit the login credentials for Admin, User 1 and User 2.

Note: Click the **Save** button to save the new login credentials.

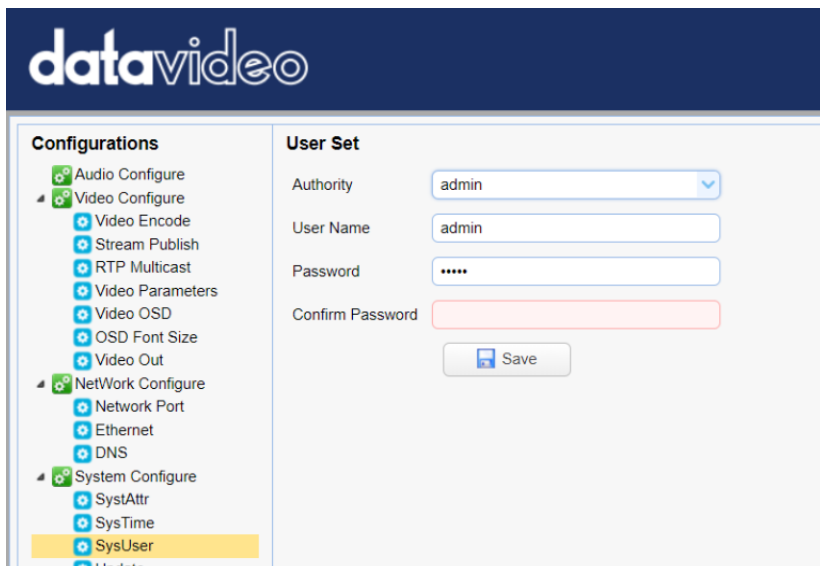

Update

This is where you will be able to view current firmware information. See [Firmware Update](#) for detailed firmware upgrade instructions.

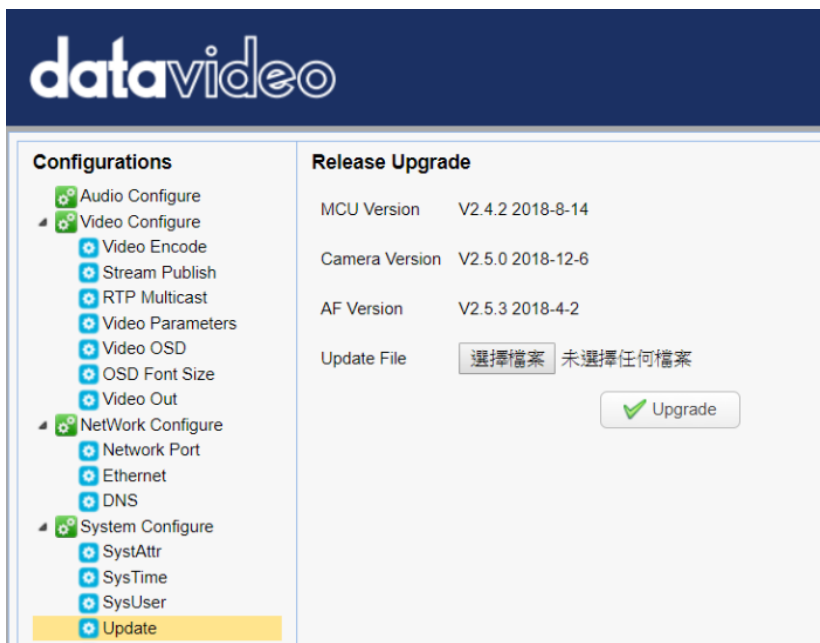

Default

In **Default**, click “**Restore factory defaults**” to reset the device to factory defaults.

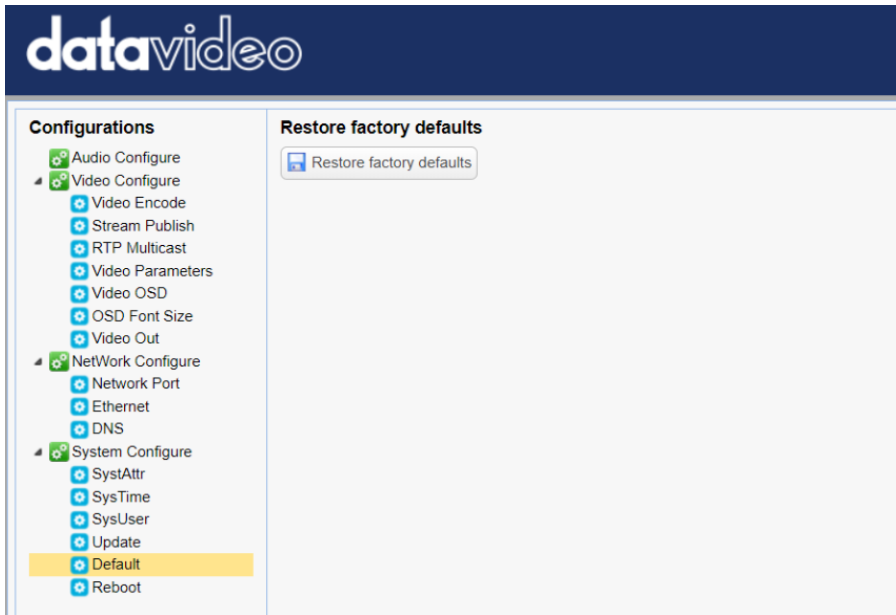

Reboot

Click “**Reboot**” to reboot the device.

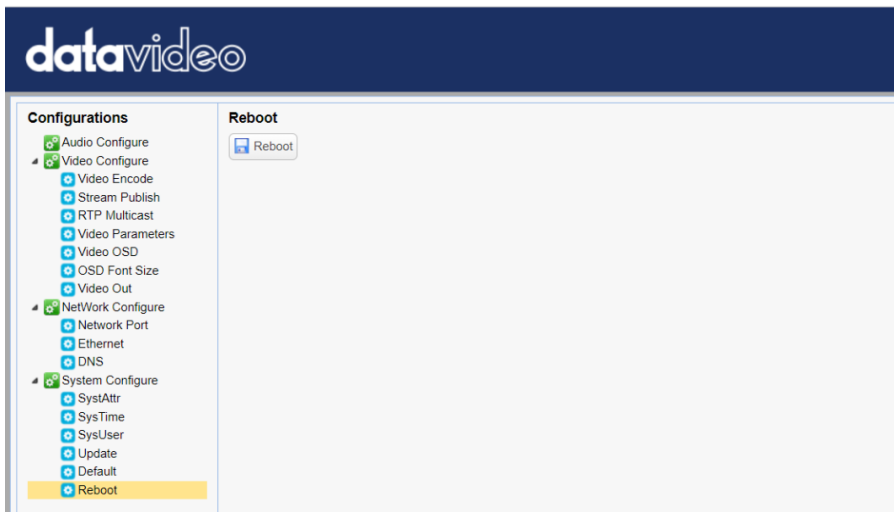

9. Remote Control Port Pinouts

In addition to using the Ethernet port for remote control, you can also connect your PC or any keyboard controllers to the RS-232 or RS-422/RS-485 remote port to control PTC-140NDI. Use an Ethernet cable to connect the external RS-232 or RS-422/RS-485 controller to PTC-140NDI. You can make your own cable using the pinout information provided in this chapter.

Remote Control Port

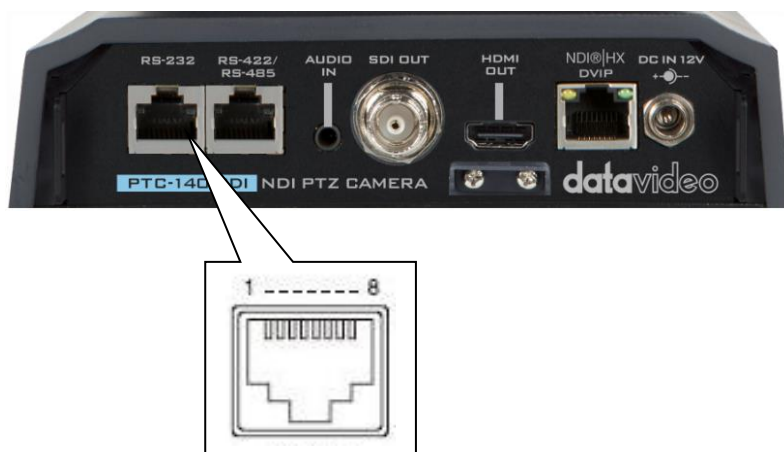

The RS-232 pinouts are described below.

No.	RJ-45 Connector	Camera's RS-232 Port
1	White/Orange	GND
2	Orange	NC
3	White/Green	NC
4	Blue	Transmit IN
5	White/Blue	NC
6	Green	Receive IN
7	White/Brown	Transmit OUT
8	Brown	Receive OUT

The RS-422/RS-485 pinouts are described below.

No.	RJ-45 Connector	Camera's RS-422/485 Port
1	White/Orange	GND
2	Orange	NC
3	White/Green	RX-
4	Blue	TX-
5	White/Blue	TX+
6	Green	RX+
7	White/Brown	NC
8	Brown	NC

10. Firmware Update

Datavideo usually releases new firmware containing new features or reported bug fixes from time to time. Customers can either download the firmware as they wish or contact their local dealer or reseller for assistance.

This section outlines the firmware upgrade process which should take **approximately few minutes to complete**.

The existing settings should persist through the firmware upgrade process, which should not be interrupted once started as this could result in a non-responsive unit.

Requirements

- PTC-140NDI Unit
- PC/Laptop
- Latest firmware files
Download from <https://www.datavideo.com/product/PTC-140NDI>
- Ethernet Cable
- Router if connected over a network

Procedure

1. Open the web user interface of the PTC-140NDI.
2. Click “System Configure” → “Update”

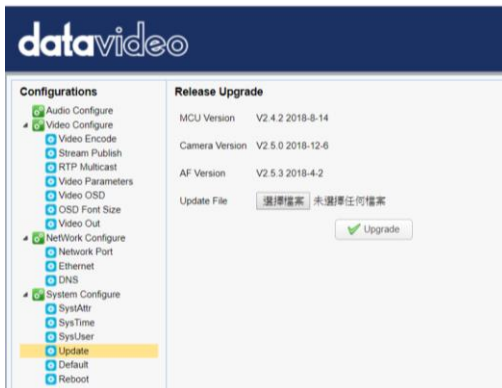

3. Click “Select File” button to browse your disk for the latest firmware file.
4. Click “Upgrade” button to start upgrading the firmware.

11. Frequently-Asked Questions

This section describes problems that you may encounter while using PTC-140NDI. If you have any questions, please refer to related sections and follow all suggested solutions. If problem still exists, please contact your distributor or the service center.

No.	Problems	Solutions
1.	What are important points for product maintenance?	<ol style="list-style-type: none"> 1. If the camera will not be used for a long time, please unplug the 12V DC power plug, and remove AC power adapter from AC outlet. 2. Use soft cloth or tissue to clean the camera. 3. After washing the camera lens, dry it with a soft dry cloth. Use a neutral detergent rather than acidic or corrosive detergents to clean the lens.
2.	There is no output video.	<ol style="list-style-type: none"> 1. Check that your power is properly connected. This is indicated by the power LED. 2. Make sure the camera is switched ON. 3. Check your video cable connection.
3.	I have seen image jitter while zooming in or out.	<ol style="list-style-type: none"> 1. Make sure the camera is properly mounted. 2. Make sure that machines that could cause vibration are not in proximity of the camera.
4.	The remote control is not working.	<ol style="list-style-type: none"> 1. Try setting the camera to CAM1 and try again. 2. Make sure the remote control's battery is fully charged. 3. Check your device working mode. 4. Make sure the OSD menu is closed. The remote control cannot be used if the OSD menu is opened.
5.	The serial port is not working properly.	<ol style="list-style-type: none"> 1. Make sure you are using the standard connection cable provided by Datavideo. 2. Make sure your baud rate and device addresses are correct. 3. Check your cable connection. 4. Check your device working mode.
6.	I cannot login the web user interface.	<ol style="list-style-type: none"> 1. Check your Ethernet connection. 2. Check your network settings such as IP address.

12. Dimensions

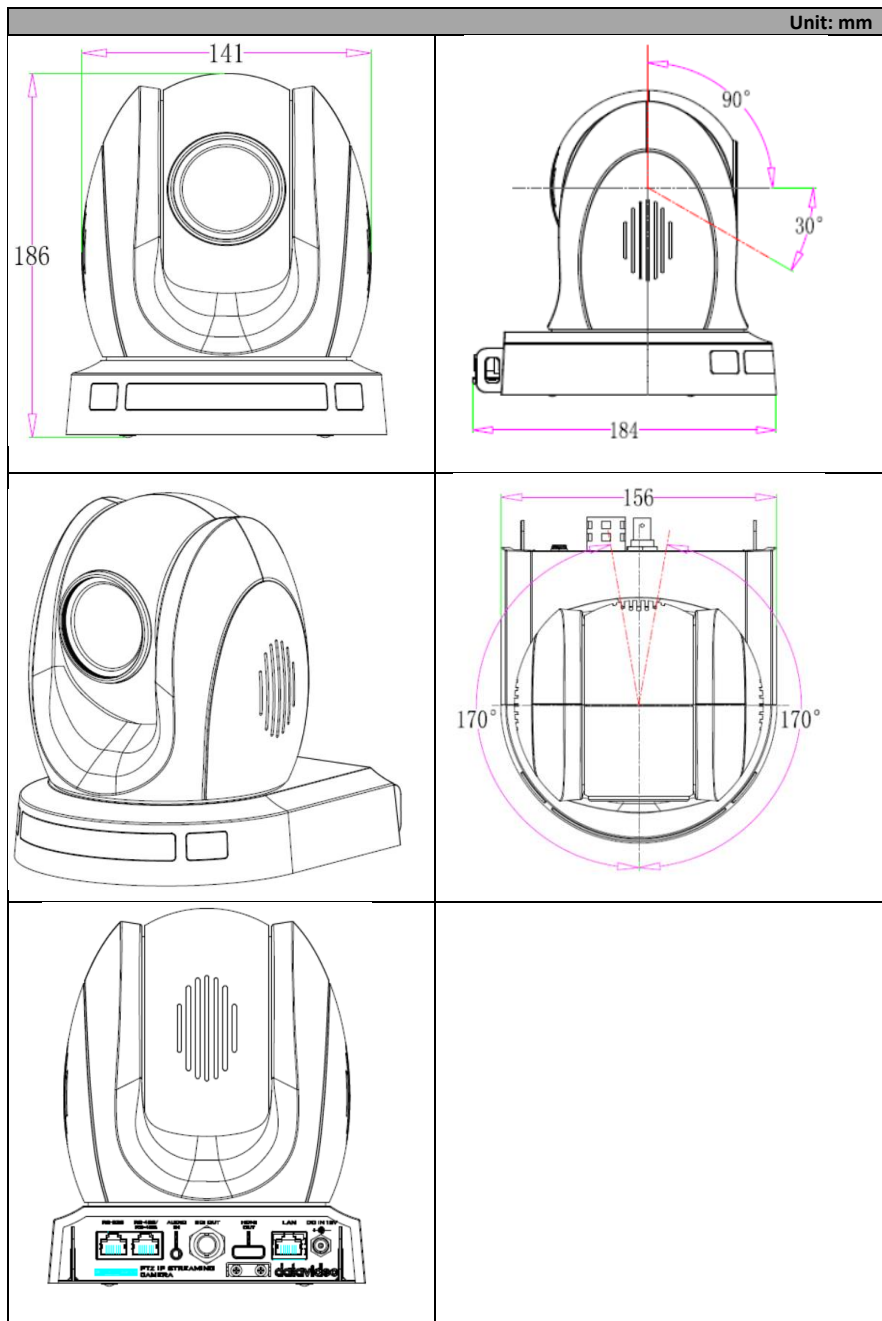

13. Specifications

Camera Parameters	
Video Format	1080p 60/59.94/50/30/29.97/25 1080i 60/59.94/50 720p 60/59.94/50
Image Sensor	1/2.8 inch high quality HD CMOS sensor
Effective Pixels (approx.)	2.07 Mega pixels
S/N Ratio	>55dB
Min. Illumination	0.5Lux (F1.8, AGC ON)
Electronic Shutter	Auto / Manual
Zoom Ratio	20x Optical Zoom, 10x Digital Zoom
Gamma Control	Off / Normal
Iris Control	Auto / Manual
Digital Noise Reductions	Yes
On-Screen Display (OSD)	English, Simplified Chinese
White Balance	Auto, Manual, One Push, 3000K, 4000K, 5000K, 6500K
AGC / Gain Control	Auto / Manual
Mirror / Flip Image	Yes
Focus Mode	Auto / Manual
Panning / Tilting Range	Pan: 340° Tilt: +90° to -30°
Panning / Tilting Speed	Pan: 0.1~60°/sec Tilt: 0.1~30°/sec
Preset	255 Positions
Focal Length	f=5.2 (wide) to 98 (tele) mm F1.6 to F3.5
Field of View (Horizontal, Wide)	Approx. 54.7° (WIDE END) / 3.3° (TELE END)

Image Compensation	Backlight Compensation
Input /Output Interfaces	
Video Output	HDMI x 1 SDI x 1
Audio Input	3.5mm Line in
Tally LED	Dual colors (Red, Green)
Lens Filter	M52.0 x 0.75 Thread with UV Protection
Control Protocol	VISCA/Pelco-D/Pelco-P; Baud Rate:115200/38400/9600/4800/2400bps DVIP, NDI
Remote Control Interface and Transmit Distance	LAN: for IP control (DVIP / NDI) RS-232, RS-422, RS-485
Video Compression Format	H.264, H.265, Dual stream output
Audio Compression Format	AAC/MP3/G.711A Audio compression
HD IP Interface	100M IP port(100BASE-TX); Support DVIP and NDI
Streaming Protocols	TCP/IP, HTTP, RTSP, RTMP, DHCP, Multicast, etc
Others	
POE	IEEE802.3af
F/W Update	Ethernet
IR Control	Yes

Camera Control Unit	RMC-180/RMC-300C/RMC-300A
Tripod Mount	1/4-20 UNC
Optional Accessories	WM-1/ WM-10/WM-11
Color	Dark Blue/White
Dimension (LxWxH)	156 x 184 x 186 mm
Weight	1.6 kg
Operating Temp. Range	0~40 °C
Power	DC 12V 12W

Notes

Service & Support

It is our goal to make your products ownership a satisfying experience. Our supporting staff is available to assist you in setting up and operating your system. Please refer to our web site www.datavideo.com for answers to common questions, support requests or contact your local office below.



Please visit our website for latest manual update.
<https://www.datavideo.com/product/PTC-140NDI>

datavideo
www.datavideo.com



@DatavideoUSA @DatavideoIndia2016
@DatavideoEMEA @Datavideojapan
@DatavideoTaiwan @DatavideoLatam
@DatavideoAsia @DatavideoBrasil



@Datavideo
@Datavideo_EMEA
@Datavideo_Taiwan



@DatavideoUSA
@DVTWDCN



@DatavideoUSA
@DatavideoEurope

All the trademarks are the properties of their respective owners.
Datavideo Technologies Co., Ltd. All rights reserved 2020