

# datavideo

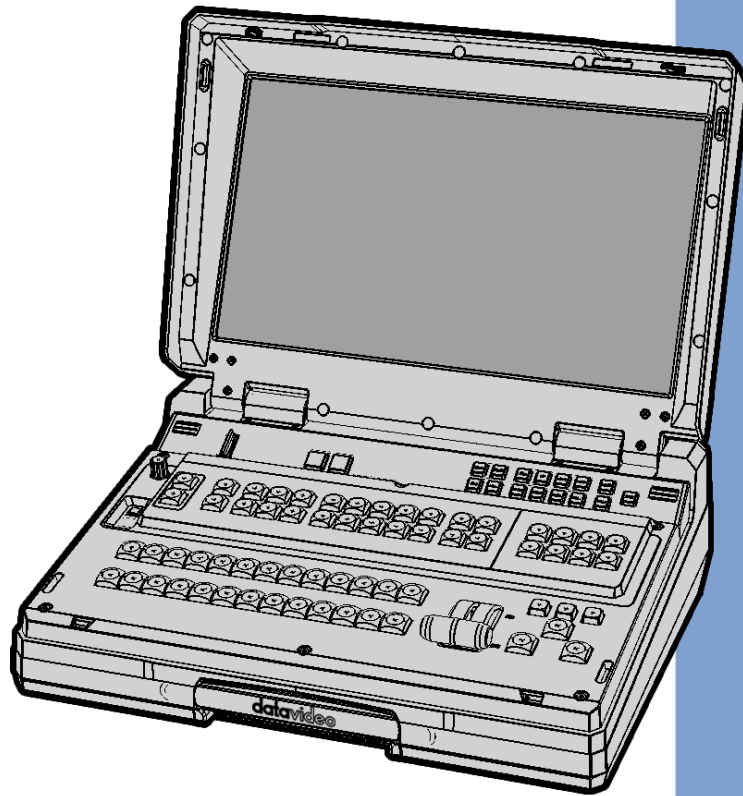

**HD 12-CHANNEL PORTABLE  
VIDEO STREAMING STUDIO**

**HS-3200**

**Instruction Manual**

[www.datavideo.com](http://www.datavideo.com)

# Table of Contents

<b>FCC COMPLIANCE STATEMENT</b> .....	<b>7</b>
<b>WARNINGS AND PRECAUTIONS</b> .....	<b>7</b>
<b>WARRANTY</b> .....	<b>8</b>
<i>STANDARD WARRANTY</i> .....	8
<i>THREE YEAR WARRANTY</i> .....	9
<b>DISPOSAL</b> .....	<b>9</b>
<b>CHAPTER 1 INTRODUCTION</b> .....	<b>10</b>
1.1 SYSTEM ARCHITECTURE .....	12
1.2 REAR PANEL OVERVIEW .....	13
1.3 CONTROL PANEL OVERVIEW.....	14
1.4 CONNECTING THE POWER SUPPLY .....	15
<b>CHAPTER 2 PREPARATION</b> .....	<b>16</b>
2.1 CONNECTING DEVICES.....	16
<i>Connecting the Video and Audio Input Devices</i> .....	16
<i>When linking via tally connection</i> .....	17
<i>Connecting the Video and Audio Output Devices</i> .....	17
<i>Connecting to a Network</i> .....	18
2.2 MULTI VIEW .....	18
<b>CHAPTER 3 NETWORK AND SOFTWARE SETUP FOR SWITCHER</b> .....	<b>19</b>
3.1 STATIC IP CONFIGURATION .....	19
3.2 DHCP MODE.....	20
3.3 OPEN SWITCHER IMAGE IMPORT/EXPORT SOFTWARE .....	22
<i>Home</i> .....	23
<i>User</i> .....	24
<i>Still</i> .....	25
<i>Clip</i> .....	26
<i>Logo</i> .....	27
<i>Ani-Logo</i> .....	28
<i>Setup</i> .....	29
<b>CHAPTER 4 OSD MENU</b> .....	<b>30</b>
4.1 START .....	38
<i>Transition</i> .....	39
<i>Type</i> .....	39
<i>Wipe Effects</i> .....	39
<i>WIPE Border</i> .....	39
<i>Position</i> .....	40

<i>Matte</i> .....	40
4.2 KEYER .....	40
<i>Keyer</i> .....	40
<i>Keyer Control</i> .....	41
<i>Key Source</i> .....	42
<i>Fill Source</i> .....	42
<i>Invert</i> .....	43
<i>Mask</i> .....	43
4.3 CHROMA .....	43
<i>Keyer</i> .....	44
<i>Key Source</i> .....	44
<i>Key Tie</i> .....	44
<i>CK Setup</i> .....	45
<i>Mask</i> .....	46
4.4 P-IN-P.....	46
<i>Keyer</i> .....	47
<i>Position</i> .....	47
<i>Fine</i> .....	48
<i>Border</i> .....	48
<i>Shade Matte (Dual Color Border)</i> .....	48
<i>Crop</i> .....	50
4.5 FLEX SRC .....	50
<i>Flex Screen</i> .....	50
<i>Keyer</i> .....	51
<i>Flex Preset</i> .....	53
4.6 INPUTS.....	54
<i>Input</i> .....	55
<i>Proc Amp</i> .....	56
<i>Audio</i> .....	56
<i>Crosspoint</i> .....	56
<i>Audio XPT</i> .....	57
4.7 OUTPUTS.....	57
<i>Outputs</i> .....	57
<i>Multiviewer</i> .....	58
<i>Tally Mode</i> .....	59
<i>GPI Out</i> .....	59
4.8 AUDIO .....	60
<i>Audio</i> .....	60
<i>PGM Audio</i> .....	60
<i>Analog Out</i> .....	61
4.9 FILES.....	61
<i>User Mems</i> .....	61
<i>Still</i> .....	62

Clip.....	64
Logo.....	66
Ani Logo .....	67
4.10 SETUP.....	68
Standard.....	68
Genlock.....	69
OutConv.....	69
Menu Mode.....	69
Menu Preference.....	69
Auto Save .....	70
Factory Default.....	70
Language.....	70
Network.....	70
Software.....	70
<b>CHAPTER 5 BASIC OPERATION.....</b>	<b>72</b>
5.1 VIDEO SWITCHING.....	72
Program and Preset rows .....	72
Black and MATTE View .....	72
Flex Output.....	73
Still button.....	73
5.2 TRANSITIONS.....	73
WIPE Selection MENU.....	75
REV Button .....	76
5.3 MANAGING STILL PICTURES .....	76
Grabbing & Saving a Still to Memory.....	76
Loading an existing Still from Memory .....	77
Deleting a saved Still from Memory.....	77
FS – Frame Store Button .....	77
Import Still Images from PC .....	78
5.4 PERFORMING A STINGER TRANSITION.....	81
Loading a Clip from Memory .....	81
Importing the Clip for Stinger Transition Effect from PC .....	82
How to Create the PNG Sequence for Stinger Transition Effect .....	83
Important things to note while creating Stinger Transition Effects .....	89
5.5 ENABLING STILL LOGO.....	90
Loading an existing Logo from Memory .....	90
Importing Still Logo from PC.....	91
5.6 ENABLING LOGO ANIMATION .....	93
Loading an existing Ani-Logo from Memory.....	93
Importing Animated Logo from PC .....	93
<b>CHAPTER 6 ADVANCED OPERATION .....</b>	<b>96</b>

6.1	PICTURE-IN-PICTURE AND DOWNSTREAM KEY .....	97
	<i>Picture-In-Picture</i> .....	97
	<i>Character Generator</i> .....	99
6.2	PLACING TEXT ON THE VIDEO USING LUMA KEY .....	100
6.3	INSERTION OF PEOPLE ONTO BACKGROUNDS (CHROMA KEY).....	102
6.4	DISPLAYING A VARIETY OF SOURCES AT THE SAME TIME.....	105
	<i>Basic Flex™ Output (Four PIP Windows)</i> .....	105
	<i>Simultaneously Enabling up to Eight PIP Windows</i> .....	109
6.5	SHORTCUT KEYS TO ASSIGNING OUTPUT SOURCES .....	111
<b>CHAPTER 7 VIDEO STREAMING AND RECORDING .....</b>		<b>114</b>
7.1	STREAMING NETWORK CONNECTION AND DEVICE SEARCH.....	114
	<i>Connecting to a DHCP Network (DHCP Mode)</i> .....	114
	<i>Connecting to a NON-DHCP Network (Static IP)</i> .....	115
	<i>Troubleshooting the Network Connection</i> .....	115
7.2	WEB USER INTERFACE.....	119
	<i>Status</i> .....	119
	<i>Operation Mode</i> .....	121
	<i>Storage</i> .....	131
	<i>CG</i> .....	132
	<i>System</i> .....	133
	<i>File Repair</i> .....	138
7.3	OPERATIONS .....	139
	<i>Video Streaming</i> .....	139
	<i>Text Overlay Video</i> .....	147
7.4	STREAM AND RECORD BUTTONS .....	148
	<i>Two Button Model</i> .....	148
	<i>Four Button Model</i> .....	150
7.5	RESTORING FACTORY DEFAULTS.....	154
7.6	FIRMWARE UPDATE.....	154
<b>CHAPTER 8 MONITOR OSD MENU .....</b>		<b>155</b>
8.1	MAIN ADJUST .....	156
8.2	COLOR .....	156
8.3	INFORMATION .....	156
8.4	SPECIAL FUNCTION .....	157
8.5	FACTORY RESET .....	157
<b>CHAPTER 9 APPENDICES.....</b>		<b>158</b>
APPENDIX 1	TALLY OUTPUTS .....	158
APPENDIX 2	GPI / GPO CONNECTIONS .....	160
APPENDIX 3	RECOMMENDED SD CARDS.....	161
APPENDIX 4	FIRMWARE UPDATE.....	163
	<i>Switcher</i> .....	163

<i>Video Streaming Server</i> .....	164
APPENDIX 5 FREQUENTLY-ASKED QUESTIONS.....	166
APPENDIX 6 DIMENSIONS .....	167
APPENDIX 7 SPECIFICATIONS .....	168
<b>SERVICE AND SUPPORT .....</b>	<b>172</b>

**Disclaimer of Product & Services**

The information offered in this instruction manual is intended as a guide only. At all times, Datavideo Technologies will try to give correct, complete and suitable information. However, Datavideo Technologies cannot exclude that some information in this manual, from time to time, may not be correct or may be incomplete. This manual may contain typing errors, omissions or incorrect information. Datavideo Technologies always recommend that you double check the information in this document for accuracy before making any purchase decision or using the product. Datavideo Technologies is not responsible for any omissions or errors, or for any subsequent loss or damage caused by using the information contained within this manual. Further advice on the content of this manual or on the product can be obtained by contacting your local Datavideo Office or dealer.

# FCC Compliance Statement

This device complies with part 15 of the FCC rules. Operation is subject to the following two conditions:

- (1) This device may not cause harmful interference, and
- (2) This device must accept any interference received, including interference that may cause undesired operation.

## Warnings and Precautions



1. Read all of these warnings and save them for later reference.
2. Follow all warnings and instructions marked on this unit.
3. Unplug this unit from the wall outlet before cleaning. Do not use liquid or aerosol cleaners. Use a damp cloth for cleaning.
4. Do not use this unit in or near water.
5. Do not place this unit on an unstable cart, stand, or table. The unit may fall, causing serious damage.
6. Slots and openings on the cabinet top, back, and bottom are provided for ventilation. To ensure safe and reliable operation of this unit, and to protect it from overheating, do not block or cover these openings. Do not place this unit on a bed, sofa, rug, or similar surface, as the ventilation openings on the bottom of the cabinet will be blocked. This unit should never be placed near or over a heat register or radiator. This unit should not be placed in a built-in installation unless proper ventilation is provided.
7. This product should only be operated from the type of power source indicated on the marking label of the AC adapter. If you are not sure of the type of power available, consult your Datavideo dealer or your local power company.
8. Do not allow anything to rest on the power cord. Do not locate this unit where the power cord will be walked on, rolled over, or otherwise stressed.
9. If an extension cord must be used with this unit, make sure that the total of the ampere ratings on the products plugged into the extension cord do not exceed the extension cord rating.
10. Make sure that the total amperes of all the units that are plugged into a single wall outlet do not exceed 15 amperes.
11. Never push objects of any kind into this unit through the cabinet ventilation slots, as they may touch dangerous voltage points or short out parts that could result in risk of fire or electric shock. Never spill liquid of any kind onto or into this unit.
12. Except as specifically explained elsewhere in this manual, do not attempt to service this product yourself. Opening or removing covers that are marked "Do Not Remove" may expose you to dangerous voltage points or other risks, and will void your warranty. Refer all service issues to qualified service personnel.

13. Unplug this product from the wall outlet and refer to qualified service personnel under the following conditions:
- a. When the power cord is damaged or frayed;
  - b. When liquid has spilled into the unit;
  - c. When the product has been exposed to rain or water;
  - d. When the product does not operate normally under normal operating conditions. Adjust only those controls that are covered by the operating instructions in this manual; improper adjustment of other controls may result in damage to the unit and may often require extensive work by a qualified technician to restore the unit to normal operation;
  - e. When the product has been dropped or the cabinet has been damaged;
  - f. When the product exhibits a distinct change in performance, indicating a need for service.

## **Warranty**

### ***Standard Warranty***

- Datavideo equipment is guaranteed against any manufacturing defects for one year from the date of purchase.
- The original purchase invoice or other documentary evidence should be supplied at the time of any request for repair under warranty.
- The product warranty period begins on the purchase date. If the purchase date is unknown, the product warranty period begins on the thirtieth day after shipment from a Datavideo office.
- All non-Datavideo manufactured products (product without Datavideo logo) have only one year warranty from the date of purchase.
- Damage caused by accident, misuse, unauthorized repairs, sand, grit or water is not covered under warranty.
- Viruses and malware infections on the computer systems are not covered under warranty.
- Any errors that are caused by unauthorized third-party software installations, which are not required by our computer systems, are not covered under warranty.
- All mail or transportation costs including insurance are at the expense of the owner.
- All other claims of any nature are not covered.
- All accessories including headphones, cables, batteries, metal parts, housing, cable reel and consumable parts are not covered under warranty.
- Warranty only valid in the country or region of purchase.
- Your statutory rights are not affected.



## Three Year Warranty

- All Datavideo products purchased after July 1st, 2017 qualify for a free two years extension to the standard warranty, providing the product is registered with Datavideo **within 30** days of purchase.
- Certain parts with limited lifetime expectancy such as LCD panels, DVD drives, Hard Drive, Solid State Drive, SD Card, USB Thumb Drive, Lighting, Non-PCIe Card and third party provided PC components are covered for 1 year.
- The three-year warranty must be registered on Datavideo's official website or with your local Datavideo office or one of its authorized distributors within 30 days of purchase.



## Disposal

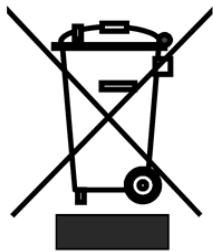

### For EU Customers only - WEEE Marking

This symbol on the product or on its packaging indicates that this product must not be disposed of with your other household waste. Instead, it is your responsibility to dispose of your waste equipment by handing it over to a designated collection point for the recycling of waste electrical and electronic equipment. The separate collection and recycling of your waste equipment at the time of disposal will help to conserve natural resources and ensure that it is recycled in a manner that protects human health and the environment. For more information about where you can drop off your waste equipment for recycling, please contact your local city office, your household waste disposal service or the shop where you purchased the product.



**CE Marking** is the symbol as shown on the left of this page. The letters "CE" are the abbreviation of French phrase "Conformité Européene" which literally means "European Conformity". The term initially used was "EC Mark" and it was officially replaced by "CE Marking" in the Directive 93/68/EEC in 1993. "CE Marking" is now used in all EU official documents.

# Chapter 1 Introduction

HS-3200 is a 12 channel professional mobile hand carry switcher with real Full 1080p/60 (3G) High Definition support, featuring 12 digital inputs including 8 SDI and 4 HDMI inputs with embedded audio, 5 SDI and 1 HDMI outputs for connecting HD recorder, external monitors and etc.

HS-3200 is a lightweight, portable and powerful featured mobile studio solution which is designed for live events and TV programs that need to mix a variety of video and audio sources. HS-3200 is also a great value solution for the worship, education and AV markets.

The HS-3200 also has powerful, easy-to-use effects, including Chroma / Luma Key, DSK, PIP, Wipe Generator, Still stores, logo insertion and built-in title overlay system for the entry level Datavideo CG.

Advanced features include a 17.3-inch Full HD 1080p video monitor, which displays the Multi-view. The Multi-view displays all video input sources, preview video and program video.

In addition, the HS-3200 offers an easy-to-use video **streaming** and **recording** device for professional video producers who need to simultaneously stream a live event and record the master quality version for post-event editing.

## **Major features**

- One machine for 12 channel 1080p video switching, recording and streaming
- Broadcast quality H.264 media streaming over RTMP(S), RTSP, TS, HLS and SRT for sending videos to broadcast platforms like Facebook, Youtube
- Record on SD Card for post-production
- Original 1080p (3G) operation
- Flexible combinations of 4 USKs and 2 DSKs
- Up to 8 PIP windows with four showing FLEX sources
- Supports 4 broadcast quality chromakeyers and
- virtual studio background images
- 17 stinger transitions

## **Summary of all features**

- 12 Total Video input interfaces: 8 x SDI (Level A/B) + 4 x HDMI
- 9 Video Output: 5 x SDI (Level A) + 1 HDMI + 3 x HDMI (Program OUT only)
- 4 Upstream Keyers, supporting Chroma key & Linear / Luma key
- 4 PIP (assignable to any of keyers)
- DSK, supporting Linear & Luma Key Modes
- Logo insertion (Animation logo, X/Y size)
- Wipe, Mix, DVE, Cut and Stinger Transitions
- 32 Wipe patterns including Circle & Heart, and Borders & Softness Control
- Clip player (150 Frames) Stinger Transitions function

- Any Input (1-12) can be used as a Frame store (Stills Store)
- Video and Audio Crosspoint Assignments (XPT)
- 4 x XLR Analogue Audio Inputs
- 2 x XLR De-embedded Analogue Audio Outputs
- Tally output
- USB Port for FW upgrade

# 1.1 System Architecture

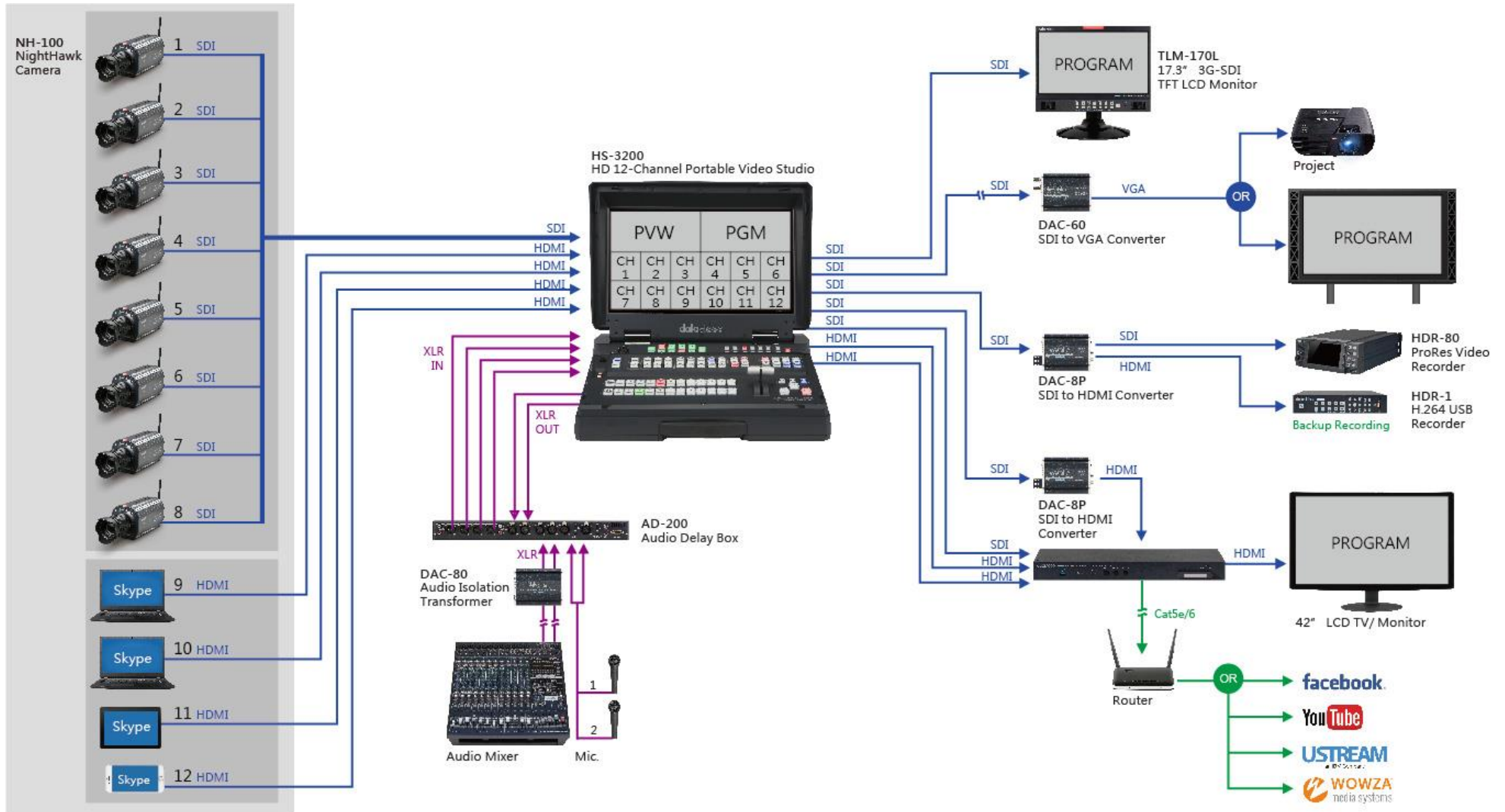

## 1.2 Rear Panel Overview

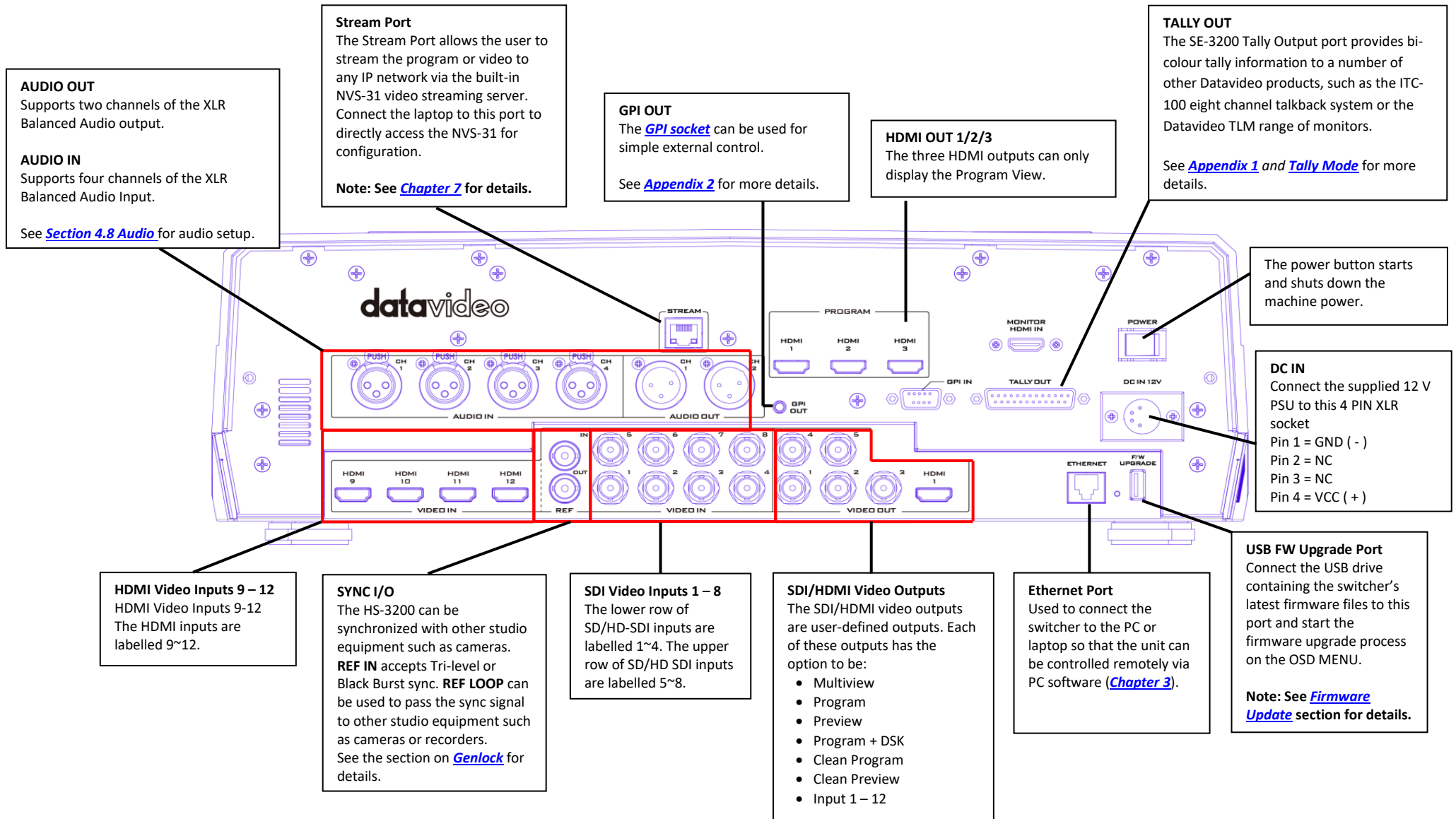

### 1.3 Control Panel Overview

Perform video switching and other relevant controls on the **Control Panel**.

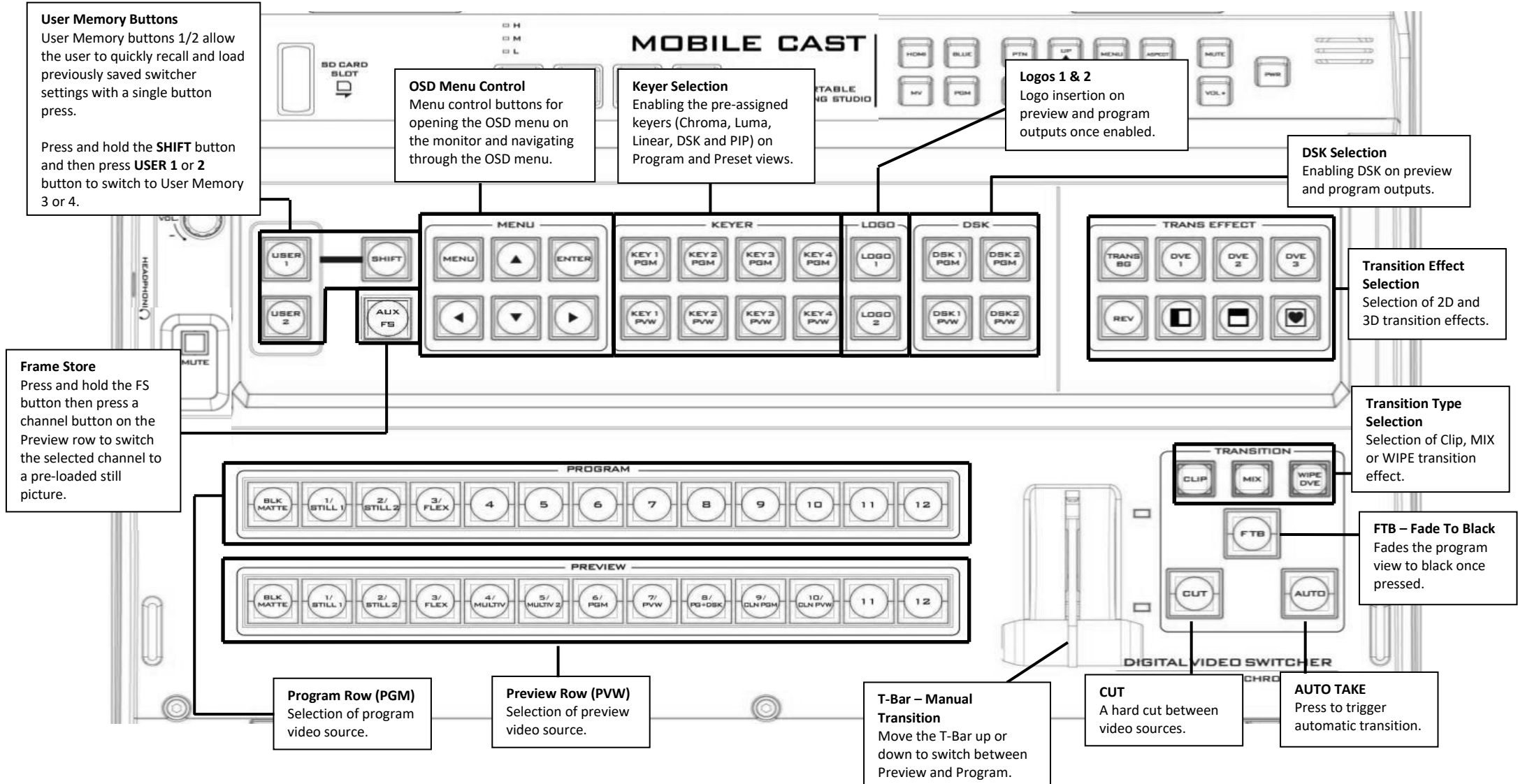

## 1.4 Connecting the Power Supply

Connect the DC output plug of the supplied AC adapter to the DC IN 12V connector on the rear of the switcher and then connect the AC adapter to a power supply.

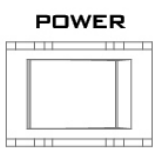
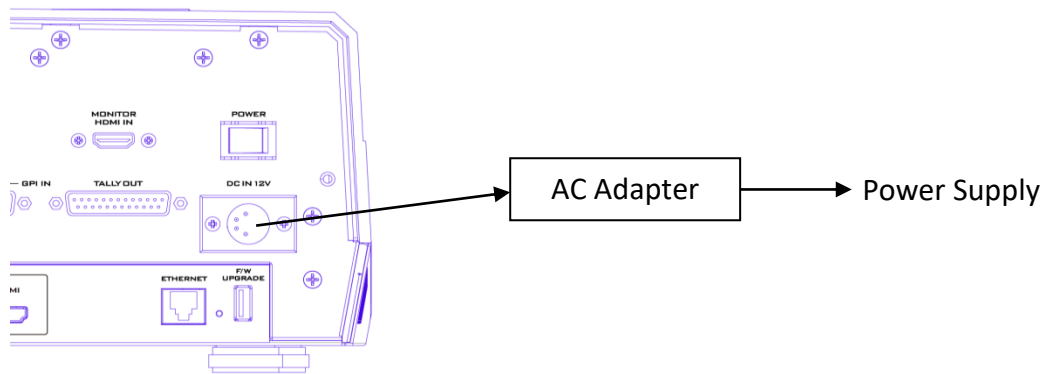

**POWER**

To start, turn **ON** the power switch.

To shut off the machine, simply turn **OFF** the power switch.

## Chapter 2 Preparation

In this chapter, we will describe various essential devices to be connected to the switcher in order to complete the system setup. If you possess the skills for setting up the production system, feel free to skip this chapter and proceed to [Chapter 5: Basic Operation](#).

### 2.1 Connecting Devices

#### *Connecting the Video and Audio Input Devices*

Connect cameras, computers and other video input devices to the video input connectors on the rear of the unit and connect an audio mixer to audio input connectors.

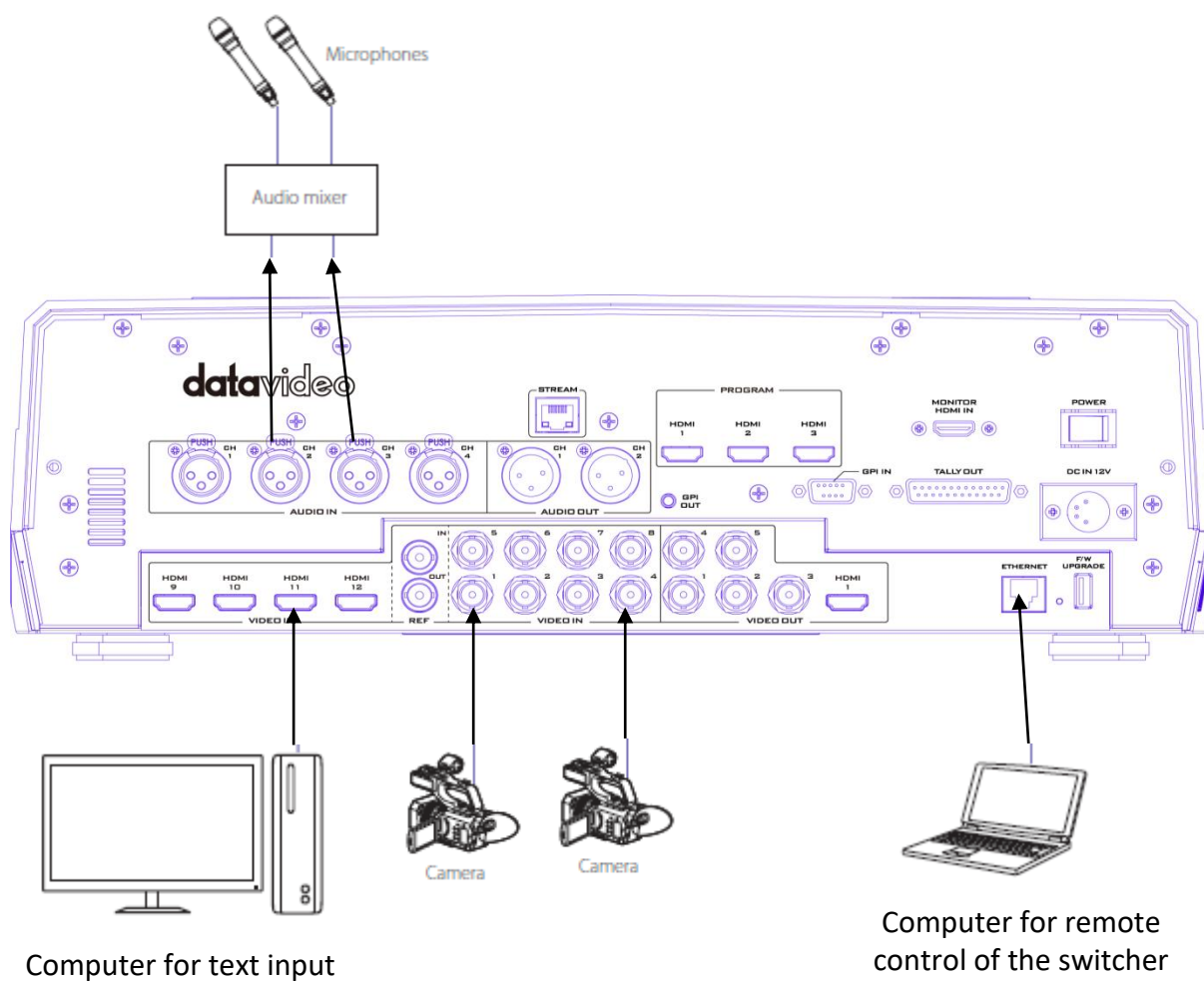



### ***When linking via tally connection***

Connect the switcher's tally connector to the tally connector on a commercially available tally box.

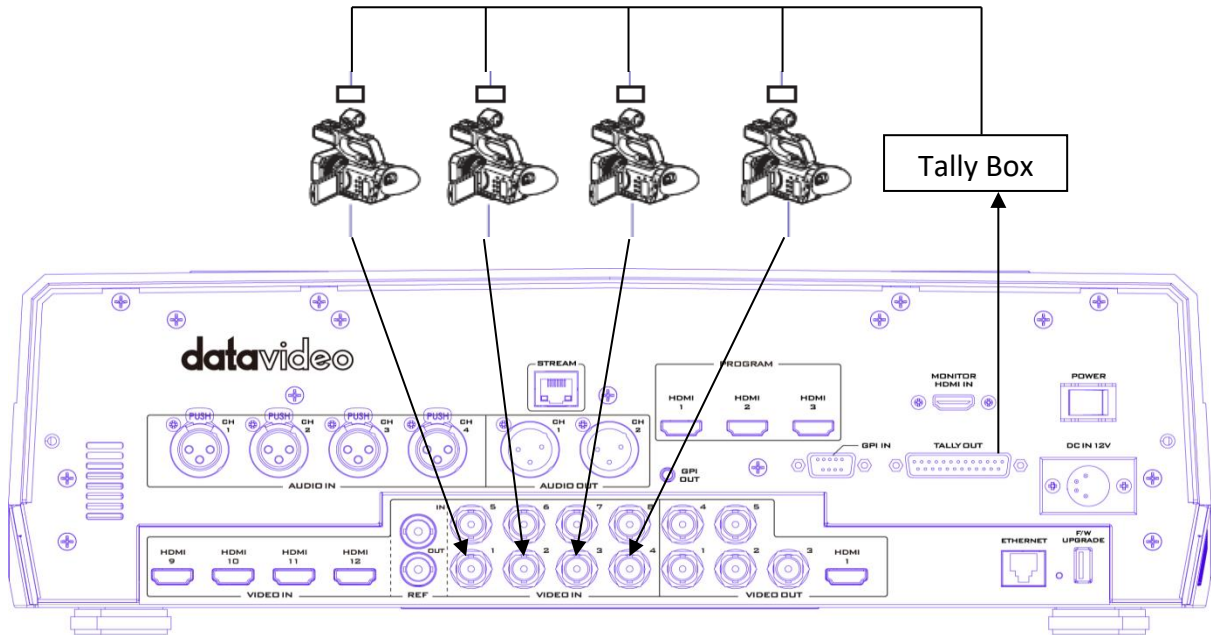

### ***Connecting the Video and Audio Output Devices***

Connect projectors, large displays and other video output devices to the video output connectors on the rear of the switcher.

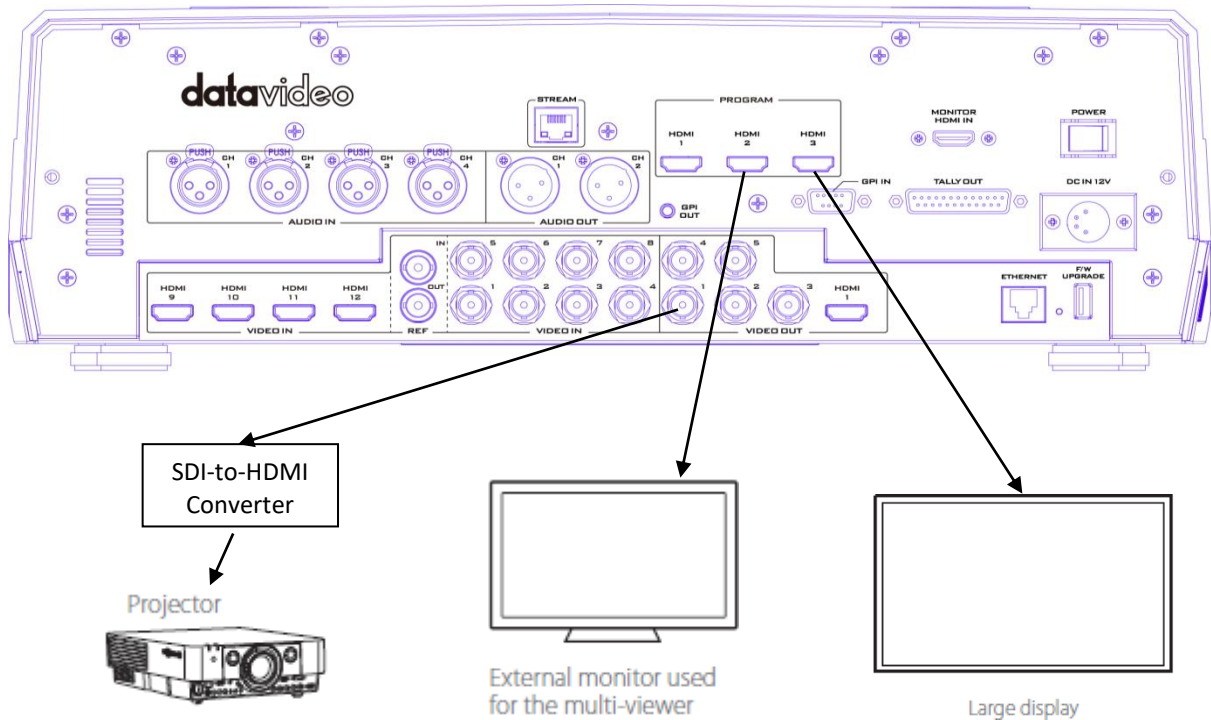

## Connecting to a Network

Use the Ethernet Port to connect the switcher to the PC with the Image Import/Export Software installed.

For details on the Switcher Image Import/Export Software, see [Chapter 3](#).

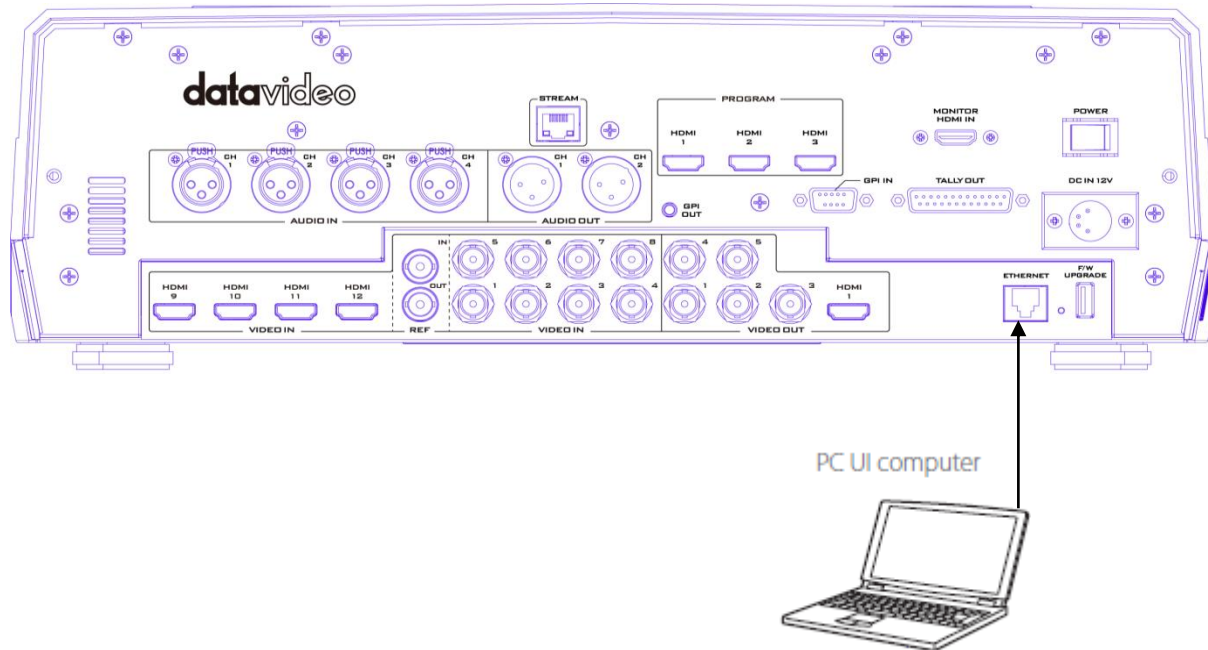

## 2.2 Multi View

The HS-3200 Multi view output can be supplied from the HDMI or SDI outputs, see Chapter 4 (4.7) for configuring the outputs. The Multi view shows monitoring images for **Preview** (PVW), **Program** (PGM) and **Inputs 1~12**. The Multi view can also show **audio level bars** overlaid on the Program image. This confirms the analogue XLR audio input is being received and embedded to the selected Program output(s).

HS-3200 Multi-view is supplied from the HDMI connection(s) on the rear panel and available across multiple HDMI monitors (not supplied). Since a variety of multi-image layouts is available, these HDMI outputs can be used to monitor video and audio in a number of different configurations. The layout of the multi view can also be changed. The sources can be swapped around using the cross point section of the Inputs menu. For each setup, embedded audio level indication is available on the Preview and Program windows.

See [Multiviewer](#) in [Section 4.7](#) for nine different multi-view layouts available on the HS-3200.

**Note:** A **Red tally indication box** will be shown around the sources selected for Program OUT and these selected sources should be displayed at the switcher's selected Program output(s). A **Green tally indication box** is shown around the sources selected for Preview. These are the next image sources to be mixed to, wiped in or cut to the Program OUT depending on the user's preference.

## Chapter 3 Network and Software Setup for Switcher

The Ethernet port on the back panel of the HS-3200 allows the user to import still images, clips for stinger transition, still logos, animated logos or user memories using the Switcher Image Import/Export software. This chapter discusses direct connection between the HS-3200 and your Windows computer as well as the remote setup in detail. **Please download the Switcher Image Import/Export software to your PC or laptop from the product page (<https://www.datavideo.com/tw/product/HS-3200>) before using this feature.**

Section 3.1 discusses how you can establish direct connection between the HS-3200 and a Windows computer. In Section 3.2, we will show you how to access the HS-3200 remotely on your PC or laptop with the **Switcher Image Import/Export software**.

### 3.1 Static IP Configuration

When new from the factory the HS-3200 will initially have a static IP address of **192.168.100.101**. The unit can be directly connected to a Windows-based computer using an RJ-45 ethernet cable. The following set up should allow you to initially configure the unit's static IP settings.

System requirements and setup are provided as follows:

- An RJ-45 Ethernet cable.
- Windows 7/8/10 laptop or PC.
- The Datavideo Switcher Image Import/Export software.

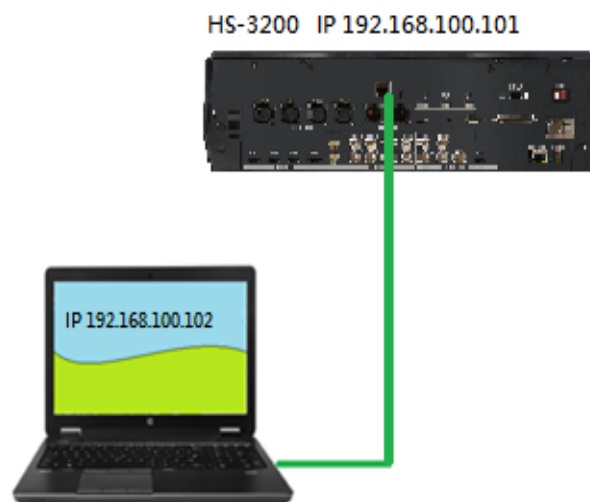
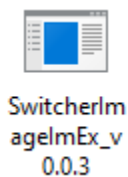

#### Instructions

1. First physically connect the HS-3200 to a Windows computer using an RJ-45 Ethernet cable.
2. Turn on the Windows computer and set it to **static IP setup** within the **Windows Network and Sharing Centre**. In our example, the computer is given the following IP settings so that the computer matches the same IP range as the switcher.

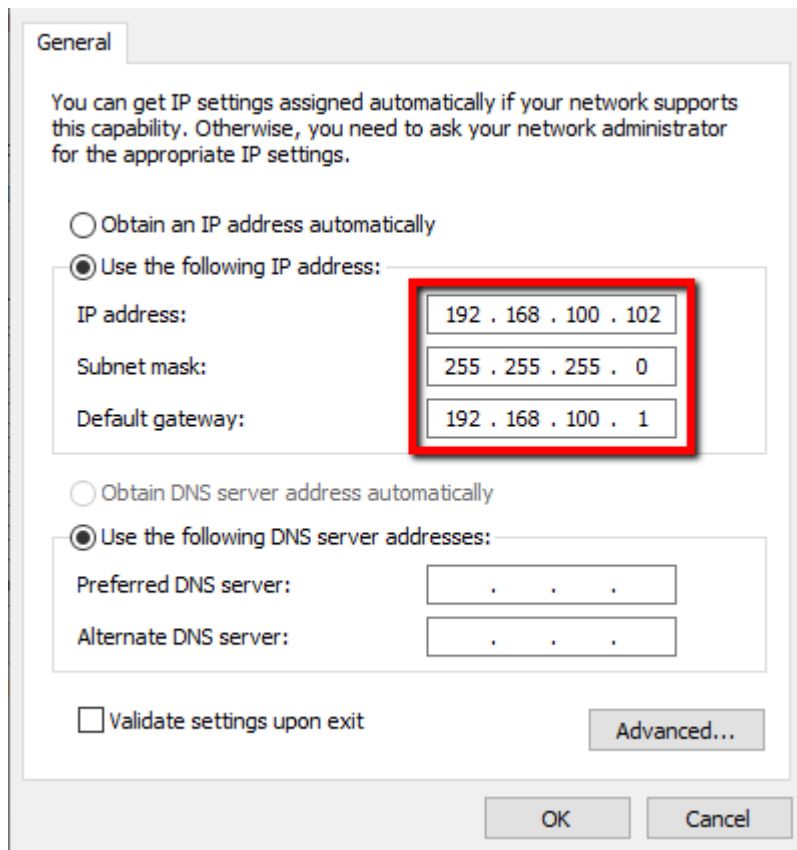

3. Now open the **Switcher Image Import/Export software** to establish connection with the switcher.

**Tip:** You can also modify the switcher's IP address on the OSD menu such that it matches the network IP range or the IP assigned to your PC. See the [Network](#) Section for details. This is also the place where you will be able to check or reset your device IP address.

**Note:** After changing your network settings, always reboot your switcher for the new settings to become effective.

## 3.2 DHCP Mode

The computer software can also access the HS-3200 over an existing TCP/IP LAN type network. In order to initially set up the HS-3200, you may need the assistance of your local I.T. specialist to help with the network settings. To help guide you, we have included a quick network setup guide as well as a simplified network setup example below; further advice may be available through your dealer locally or your Datavideo regional office.

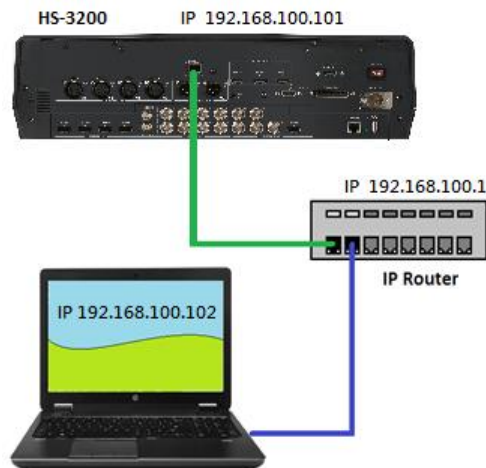

To create this simple dedicated HS-3200 IP network you will need:

- An IP router which can assign/give IP addresses.
- Two RJ-45 patch leads.
- Windows 7/8/10 laptop or PC.
- The IP router Administrator login and password.
- The Datavideo Switcher Image Import/Export software.



SwitcherImageImportExport\_v  
0.0.3

### Instructions

1. First connect the router to the HS-3200 and the Windows computer using two RJ-45 patch leads.
2. Turn on the Windows computer and set it to **DHCP setup** within the **Windows Network and Sharing Centre**.

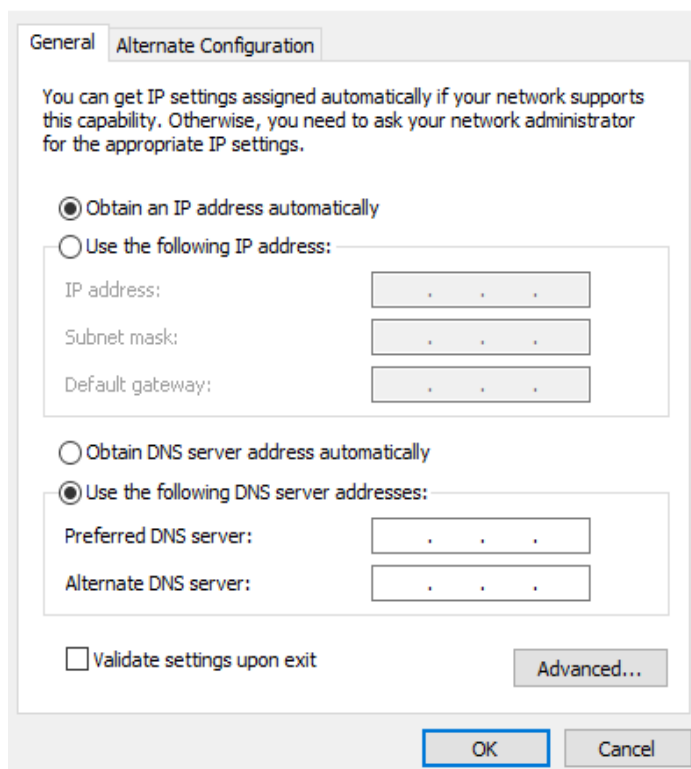

3. Press the **MENU** button on the HS-3200 control panel to open the OSD menu on the connected Multiview monitor. Open the OSD menu → **Setup** → **Network** and then change the **Addr Mode** to **DHCP** from the default **Static IP**. Move to the **SAVE** option and press the **ENTER** button to save new settings.
4. Reboot the HS-3200 and after the machine is rebooted, open the **Network** sub menu by following the instructions outlined in the previous step. The **IP Addr** option should show an IP address assigned randomly by the router thus having the same IP range as the router. If you see an IP address of 0.0.0.0 in the **IP Addr** field, it is likely that the router requires longer time to assign an IP address to the connected devices. Close the **Network** sub menu and reopen after 30-60 seconds, you should be able to see the newly assigned IP address. If problems still exist, contact any IT specialists for assistance.

### 3.3 Open Switcher Image Import/Export Software

After configuring your connection mode, download and unzip the **Switcher Image Import/Export software** then in the unzipped folder, double click the software icon to open the program.

The **Switcher Image Import/Export software** has a built-in IP finder, which is designed for PC with multiple Ethernet cards or DHCP network environment. Upon launch of the **Switcher Image Import/Export software**, you will be prompted to select one Ethernet Interface Card. **Please note that the IP finder can only find devices connected to the same network as the PC.**

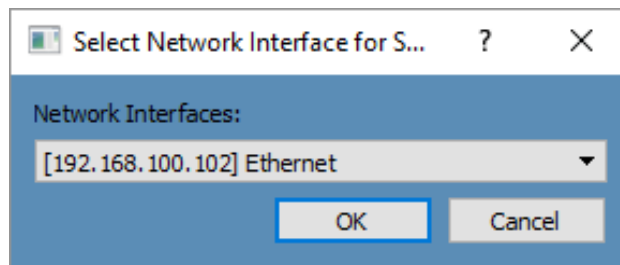

Once selected, click **OK** to start the scanning process.

**Note: Please make sure the selected interface card is on the same network as the HS-3200 device.**

Once the HS-3200 device is found, the software will connect with the switcher over the IP set up described in the previous section. If the connection is successfully established, on the software user interface as shown in the diagram below, the **Connect Status** will show **“Connected”** (will display **Not Connected** if disconnected).

Brief descriptions of buttons on the **MENU SELECT** pane are outlined as follows:

- **Home:** Interface main page showing connection status and transition time settings.
- **User:** User memory import
- **Still:** Still image import

- **Clip:** Clip file import
- **Logo:** Still logo import
- **Ani-Logo:** Animated logo import
- **Setup:** Software settings

## Home

As soon as the program is opened, you will see the interface home as shown in the diagram below. The function items are described as follows:

- Connect Status: Shows “**Connected**” if the program establishes connection with the switcher successfully; shows “**Not Connected**” otherwise.
- ME Trans: Sets MIX EFFECT transition time in frames. See also OSD Menu → [Start](#) → **M/E**.
- DSK Trans: Sets DSK transition time in frames. See also OSD Menu → [Start](#) → **DSK**.
- FTB Trans: Sets Fade-to-Black transition time in frames. See also OSD Menu → [Start](#) → **FTB**.



## User

Click the **User** button to view all the .mem files saved on the switcher.

To import .mem files from your PC, click “**User**” then enter a memory location. Click “**Import User**” to browse your hard drive and select the user memory file that you would like to import.

See section 4.9, [User Mems](#), for more details.

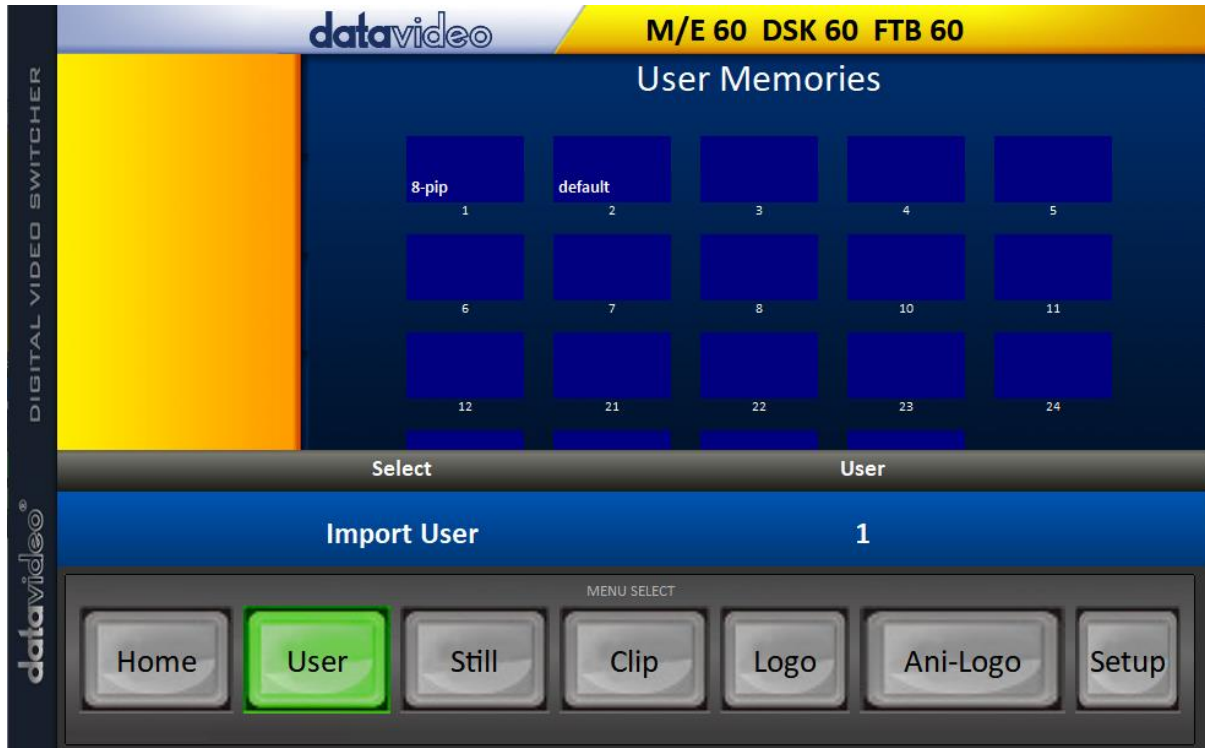



## Still

Click the **Still** button to view all the still images saved on the switcher.

To import still image files from your PC, click “**Still**” then enter a memory location. Click “**Import Still**” to browse your hard drive and select the image file that you would like to import.

See section 4.9, [Still](#), and section 5.3, [Managing Still Pictures](#), for more details.



## Clip

Click the **Clip** button to view all the clips saved on the switcher.

To import clip files from your PC, click “**Clip**” then enter a memory location. Click “**Import Clip**” to browse your hard drive and select the clip file that you would like to import.

See section 4.9, [Clip](#), and section 5.4, [Performing a Stinger Transition](#), for more details.



## Logo

Click the **Logo** button to view all the still logo images saved on the switcher.

To import still logo image files from your PC, click “**Logo**” then enter a memory location. Click “**Import Logo**” to browse your hard drive and select the logo image file that you would like to import.

See section 4.9, [Logo](#), and section 5.5, [Enabling Still Logo](#), for more details.



## Ani-Logo

Click the **Ani-Logo** button to view all the animated logos saved on the switcher.

To import animated logo files from your PC, click “**Ani-Logo**” then enter a memory location. Click “**Import Ani-Logo**” to browse your hard drive and select the animated logo that you would like to import.

See section 4.9, [Ani-Logo](#), and section 5.6, [Enabling Logo Animation](#), for more details.



## Setup

On the **Setup** page, you will be able to view the software version, network connect status, firmware version installed and the available space on the switcher.

The **Setup** page allows you to reset the software to its defaults, and change the interface language. The available languages are **English**, **Traditional Chinese**, and **Simplified Chinese**. Click **Save Setup** to apply the new settings.

The **Target IP Address** is the IP address of the switcher that you would like to connect. Enter the IP then click **SCAN** to connect to the switcher.

The screenshot displays the web interface for a datavideo switcher. The top header shows the brand name 'datavideo' and the model 'M/E 60 DSK 60 FTB 60'. A vertical sidebar on the left reads 'DIGITAL VIDEO SWITCHER'. The main content area is a table with system information:

Image Import/Export	
Software Version	0.0.3.0
Network connect status	Connected
Processor Unit	
software version	v0.9.9.9
FPGA Version	2019-7-22
Target IP Address	192.168.100.101
Network Mask	255.255.255.0
Gateway	192.168.1.254
Free Space	1073 frames

Below the table is a control bar with the following elements:

- Target IPAddr: 192.168.100.101
- Search Device: Scan
- Select: Factory Def
- Language: English
- Select: Save Setup

At the bottom is a 'MENU SELECT' bar with buttons for Home, User, Still, Clip, Logo, Ani-Logo, and Setup. The Setup button is highlighted in green.

## Chapter 4 OSD MENU

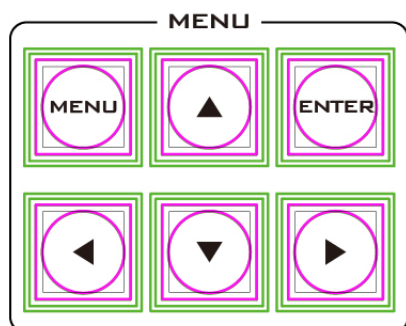

The switcher's OSD menu allows the user to perform several configurations of image effects, such as Picture-in-Picture, chroma key, subtitle overlay, still pictures and etc. The user can also configure the I/O by selecting different input and output options. In addition, in the setup menu, the user is allowed to set the menu color, size, position and language.

The OSD Menu can be opened in basic or advanced mode.

The basic mode is generally a condensed version of the advanced menu mode. The following sub-sections will show you the various options available in these two modes.

### Overview

Main Options	Sub-Options	Parameters	
Start	Transition (Duration)	M/E	Mix Effect (0 - 9999 Default: 15)
		DSK	Downstream Key Effect (0 - 9999 Default: 15)
		FTB	Fade-to-Black Effect (0 - 9999 Default: 60)
	Type	DVE	
		Clip	
		Wipe	
		Mix	
	Wipe Effects	Wipe	Wipe Effect Presets (1 - 32 Default: 1)
		Soft	Border Softness (0 - 100% Default: 0%)
		Width	Border Width (0 - 100% Default: 1%)
	Border	Luma	Border Color Luma (0 - 100% Default: 100%)
		Sat	Border Color Saturation (0 - 100% Default: 80%)
		Hue	Border Color Hue (0 - 355 +/-5 Default: 0)
	Position	X	Horizontal Position (0 - 1600% Default: 0%)
		Y	Vertical Position (0 - 1600% Default: 0%)
Matte	Luma	Background Matte Luma (0 - 100% Default: 100%)	
	Sat	Background Matte Saturation (0 - 100% Default: 80%)	
	Hue	Background Matte Hue (0 - 355 +/-5)	
Keyer	Keyer	DSK 2 DSK 1 Key 4 Key 3 Key 2 Key 1 Flex Key 1 Flex Key 2	Keyer Selection (Default: Key 4)
		Fine / Normal	Fine: High keying quality Normal: Original keying quality
	Keyer Ctrl	Full	Type of Keyer (Default: Linear)

		Chroma Luma Linear		
		<b>Select one</b>	P-in-P Self Split	Self: One input keyer (Default) Split: Dual input keyer P-in-P window enable
		Lift		Parameter for dark/black areas of the overall foreground key image, ranging from -100% to +100% (Default: 0%).
		Gain		Parameter for light/white areas of the overall foreground key image, ranging from 0 to 16.0 (Default: 1.0).
		Opac		Parameter for transparency of the overall foreground key image, ranging from 0% to 100% (Default: 100%).
		Invert		OFF: Luma key removes black background by default ON: Luma key removes white background after <b>INVERT</b> is turned <b>ON</b> .
	Key Source	Bars Matte Flex Src 2 Flex Src 1 Still 2 Still 1 Input 12 Input 11 Input 10 Input 9 Input 8 Input 7 Input 6 Input 5 Input 4 Input 3 Input 2 Input 1 Black		Key Source Selections (Default: Input 4)
		Fill		Fill Source Selection from Bars / Matte / Flex Src 2 / Flex Src 1 / Still 2 / Still 1 / Input 12 / Input 11 / Input 10 / Input 9 / Input 8 / Input 7 / Input 6 / Input 5 / Input 4 / Input 3 / Input 2 / Input 1 / Black (Default: Black)
	Mask	Left		Left sets the left edge of the keyer mask (Default: 0%).
		Right		Right sets the right edge of the keyer mask (Default: 0%).
		Top		Top sets the top edge of the keyer mask (Default: 0%).
		Bottom		Bottom sets the bottom edge of the keyer mask (Default: 0%).
	Chroma	Keyer	Flex Key 2 Flex Key 1	Keyer Selection (Default: Key 4)

		DSK 2 DSK 1 Key 4 Key 3 Key 2 Key 1	
		Fine / Normal	Fine: High keying quality Normal: Original keying quality
	Key Source	Bars Matte Flex Src 2 Flex Src 1 Still 2 Still 1 Input 12 Input 11 Input 10 Input 9 Input 8 Input 7 Input 6 Input 5 Input 4 Input 3 Input 2 Input 1 Black	Key Source Selections (Default: Input 4)
	Key Tie	ON/OFF	Still 1/2 Input 1 – 12 Flex Src 1/2 Off
	CK Setup	CK Auto	Calculation of the best Hue & Luma values for the current Keyer source
		Hue	Parameter for color of the chroma key, ranging from 0 to 355 (Default: 110).
		Luma	Parameter for luma of the chroma key, ranging from 0 to 100% (Default: 80%).
		K Range	Setting the range of colors that match the background color to be keyed, ranging from 0 to 355 (Default: 160).
		K Fgnd	Adjusts the performance of the chroma key in dark or black areas, ranging from 0% to 100% (Default: 10%).
		K Bgnd	Adjusts the performance of the chroma key in light or white areas, ranging from K Fgnd value (min = 0) to 100% (Default: 20%).
		Hi-Light	Boosts the foreground key in high luminance area, ranging from 0 to 100% (Default: 0%).
		Lo-Light	Boosts the foreground key in low luminance area, ranging from 0 to 100% (Default: 0%).
		Bg-Supp	Bg-Supp turns ON/OFF background suppress (Default: OFF).



		Left	Trims the left edge of the key object (0 - 100% Default: 0%).	
		Right	Trims the right edge of the key object (0 - 100% Default: 0%).	
		Soft	Distinctiveness of key edge (0 - 100% Default: 0%)	
		Mask		
	Mask	Left	Left sets the left edge of the keyer mask (Default: 0%).	
		Right	Right sets the right edge of the keyer mask (Default: 0%).	
		Top	Top sets the top edge of the keyer mask (Default: 0%).	
		Bottom	Bottom sets the bottom edge of the keyer mask (Default: 0%).	
P-in-P	P-in-P	Key 1 Key 2 Key 3 Key 4 Flex PinP 1 Flex PinP 2 Flex PinP 3 Flex PinP 4	Selection of PIP windows	
		Fine	Normal Fine	
	Position	X	Horizontal PIP Position (-100 - 100% Default: -20%)	
		Y	Vertical PIP Position (-56 - 56% Default: 10%)	
		Size	PIP Size (2 - 100% Default: 40%)	
	Border	Border	Border Off Normal Shaded 3D Bevel Bevel Shaded Dual Bevel Bevel Flat Flat Bevel 3D Glass Dual Glass Glass Flat Flat Glass Circle Circle Shaded Rounded Rounded Shaded	Selection of border style (Default: Normal)
			Luma	PIP Border Luma (0 - 100% Default: 100%)
			Sat	PIP Border Color Saturation (0 - 100% Default: 80%)
			Hue	PIP Border Color Hue (0 - 355 +/-5 Default: 0)
			Width	PIP Border Width (0 - 100% Default: 2%)
			Soft	Distinctiveness of Border Edge (0 - 100% Default: 0%)

		Opac	Border transparency (0 - 100% Default: 100%)		
	Shade Matte	Luma	Shade Matte Luma (0 - 100% Default: 100%).		
		Sat	Shade Matte Saturation (0 - 100% Default: 80%).		
		Hue	Shade Matte Color (0 - 355 +/-5 Default: 60).		
		Shade Soft	This blurs or softens the Shade Matte area (0 - 100% Default: 2%).		
		Shade Pos	Sets position of the boundary line between Shade Matte and Border Matte (0 - 100% Default: 50%).		
		Direction	Direction of light source (0 - 355 +/-5 Default: 35).		
	Crop	Left	Left Edge of the Crop (0 - 100% Default: 0%).		
		Right	Right Edge of the Crop (0 - 100% Default: 0%).		
		Size	Size of the Crop (0 - 100% Default: 0%).		
		Top	Top Edge of the Crop (0 - 100% Default: 0%).		
		Bot	Bottom Edge of the Crop (0 - 100% Default: 0%).		
		Soft	Transparency and range of the crop edge (0 - 100% Default: 0%).		
	Flex Src	Flex Src	Flex Src 1 Flex Src 2		
		Flex Src Bgnd	Bars Matte	Selection of Flex Screen sources and default is Black. Set <b>ON</b> to enable the respective P-in-P window, and <b>OFF</b> to disable.	
P-in-P 1 Src		Flex Src			
P-in-P 2 Src		Still 2			
P-in-P 3 Src		Still 1			
P-in-P 4 Src		Input 1-12 Black			
Keyer 1		<b>Key Source:</b> Bars Matte Still 2 Still 1 Input 1-12 Black	<b>Fill Source:</b> Bars Matte Still 2 Still 1 Input 1-12 Black	Enable: ON/OFF	
Keyer 2		<b>Key Source:</b> Bars Matte Still 2 Still 1 Input 1-12 Black	<b>Fill Source:</b> Bars Matte Still 2 Still 1 Input 1-12 Black	Enable: ON/OFF	
Flex Preset		Preset 1 Preset 2 Preset 3 Preset 4 Preset 5 Preset 6	Selection of Flex Screen layout.		
Inputs		Input	Input 1-12	Selection of an input to set the mode (Default: Input 1).	

		Mode	Three input modes are Live, Freeze, and Still (Default is Live).	
		Mode	Off	Mode disabled
			TC-200 Md	Enables built-in TC-200 <b>Note: This option is only available at Input 9 to 12.</b>
			Zoom Md	<b>Zoom:</b> Enlarges or shrinks the selected input image horizontally and vertically at the same time. <b>X:</b> Enlarges or shrinks the selected input image horizontally. <b>Y:</b> Enlarges or shrinks the selected input image vertically.
	Proc Amp	Black	Black level (0 - 100% Default: 0%)	
		White	White level (0 - 100% Default: 100%)	
		Chrom	Chroma level (0.0 - 16.0 Default: 1.0)	
	Audio	Gain	Audio volume of a selected video input (-60 - 24 dB Default: 0 dB).	
		Delay	Audio delay of a selected video input (0 - 340 ms Default: 0 ms).	
	Crosspoint	Input 1-12 Off	Assign the selected input source to an input button (Default is Input 1).	
	Audio XPT	Input 1-12 External Follow	Associate the audio component of a selected input source to an input button (Default is Follow).	
Outputs	Output	SDI 1 SDI 2 SDI 3 SDI 4 SDI 5 HDMI	Flex Src 2 Flex Src 1 Still 2 Still 1 Input 1 – 12 CLN PVW (Clean PVW) CLN PGM (Clean PGM) PG + DSK PVW PGM MultiV2 MultiV (Multi view) (SDI default: PGM / HDMI default: MultiV)	
	Multiviewer	AutoNum	Auto number input labels (ON/OFF (Default))	
		Label Inf	Input label is followed by information which describes the input as still, live or frozen image (ON/OFF (Default))	
		Trns Lab	Turn the background of the label from a solid colour to transparent (ON/OFF (Default))	
		MV1	Multiview Layout Modes User 1 – 8 Preset 1 – 9 <b>Default: Preset 3</b>	
		MV2	Multiview Layout Modes User 1 – 8	

			Preset 1 – 9 <b>Default: Preset 3</b>	
		L: PGM / R: PVW L: PVW / R: PGM	<b>Default: L: PVW / R: PGM</b>	
	Tally Mode	Audio Mixer	Selection of tally light mode (Default: Normal)	
		Normal		
	GPI Out	ON/OFF	GPI Enable/Disable (Default: OFF)	
		Mode	Level/Pulse (Default: Pulse)	
		Width	Pulse width (Default: 1)	
		Input 1-12	GPI-out assignment (Default: Input 1)	
		Delay	0-99 (Default: 0)	
	Audio	Audio	Mode	Turns <b>ON/OFF</b> embedded component at SDI-out and HDMI-out.
Src			Selection of audio out source: <b>PGM Audio (Default)</b> / Follow / Input 1-12	
PGM Audio		Mode	Audio transition style: X Fade / <b>V Fade (Default)</b>	
		Gain	Audio volume of a selected video input Range: -60 - 24 (dB) with <b>default = 0 dB</b>	
		Delay	Audio delay of a selected video input Range: 0 - 340 ms with <b>default = 0 ms</b>	
Analog Out		Src	Selection of audio out source: <b>PGM Audio (Default)</b> / Follow / Input 1-12	
		Gain	Audio out volume Range: -60 - 24 (dB) with <b>default = 0 dB</b>	
		Delay	Audio out delay Range: 0 - 340 ms with <b>default = 0 ms</b>	
Files – Stills		Load Still	Load	Pressing this button loads the selected still picture source
			Still Num	0-999 (Default = 1)
	Destination		Still 1 (Default) Still 2 Input 1 – 12	
	Thumbnail Picture - 1		Preview of the previous image	
	Thumbnail Picture		Preview of the image to be loaded	
	Thumbnail Picture + 1		Preview of the next image	
	Save Still	Save	Pressing this button saves the selected still picture	
		Source	Still 1 (Default) Still 2 Input 1 – 12	
		Still Num	0-999 (Default = 1)	
		Delete	Remove still from a memory location	
	Grab Still	Grab	Press this button to grab the current program view	
		Grab Destination	Still 1 (Default) Still 2	
	Files – User Mems	Load Mem	Memory	Memory Selection from 1 to 999 (Default: 1)
Load			Selection of this button loads the selected memory	

	Save Mem	Memory	Memory Selection from 1 to 999 (Default: 1)
		Save	Selection of this button saves to the selected memory
Files – Clip	Load Clip	Load	Selection of this button loads the selected clip
		Clip Memory Location	Memory locations from 0 to 999 (Default = 0)
		Clip Settings	Sets the clip's start and end frames and the transition frame. Start Frm End Frm Mid Frm
		Thumbnail Clip - 1	Preview of the previous clip
		Thumbnail Clip	Preview of the clip to be loaded
		Thumbnail Clip + 1	Preview of the next clip
		Clear Clip	Clear the loaded clip
		Delete Clip	Remove clip from a memory location
		Files – Logo	Load Logo
Logo Memory Location	Memory locations from 0 to 999		
Destination	Logo 1 Logo 2		
Thumbnail Logo - 1	Preview of the previous logo		
Thumbnail Logo	Preview of the logo to be loaded		
Thumbnail Logo + 1	Preview of the next logo		
Clear Logo	Clear the loaded logo		
Delete Logo	Remove logo from a memory location		
Logo 1	X		X coordinate from -50 to +50
	Y		Y coordinate from -50 to +50
Logo 2	X		X coordinate from -50 to +50
	Y		Y coordinate from -50 to +50
Files – Ani-Logo	Load Ani Logo		Load
		Logo Memory Location	Memory locations from 0 to 999
		Destination	Logo 1 Logo 2
		Thumbnail Logo - 1	Preview of the previous animated logo
		Thumbnail Logo	Preview of the animated logo to be loaded
		Thumbnail Logo + 1	Preview of the next animated logo
		Clear Ani Logo	Clear the loaded animated logo
	Delete Ani Logo	Remove animated logo from a memory location	
	Logo 1	X	X coordinate from -50 to +50
		Y	Y coordinate from -50 to +50
	Logo 2	X	X coordinate from -50 to +50
Y		Y coordinate from -50 to +50	
Setup	Standard	1080p/50/59.94/60 1080i/50/59.94/60 720p/60/59.94/50	Resolution Selection
		Level	Audio Standards EBU SMPTE AUTO (Default)

	Save Setup	Saves the selected resolution
Genlock	On/Off	
	H Phase	-2190 – 2190 ms
	V Phase	-1124 – 1124 ms
OutConv	Off 1080i50/59.94 720p50/59.94	Resolutions available for downconvert at SDI Out 5
Menu Mode	Advanced	Full (Default)
	Basic	Reduced
	Brightness	1 – 5 (Default: 5)
Menu Pref	Blue / Grey	Selection of menu color
	Transp	Menu transparency level of 0/1/2 (Default: 1)
	Position	This option sets the menu position Bottom (Default) Right Left Top Centre
Auto Save	ON / OFF	Automatically saves the last settings before the machine is shut down; once turned ON auto save also occurs upon every Still Load.
Factory Def	Restore	Factory Default Reset loads the default configuration from memory point 0 for all configuration options except for the Setup.
	Restr Names	Resets the Multiviewer labels to the default settings
Language	English Traditional Chinese Simplified Chinese	
Network	Addr Mode	DHCP(Default) / Static
	IP Addr	
	Network Mask	
	Cancel / Save	
	Network Def	Yes / No
Software	Upgrade	This starts the FW upgrade process See the <b><i>Firmware Upgrade</i></b> section.

## 4.1 Start

The Start menu allows the user to set the transition time, the transition type as well as various wipe effects. The menu options are shown below.

### Advanced mode

Start	Transition	M/E	15	DSK	15	FTB	60
	Type	MIX					
	Wipe Effects	Wipe	1	Soft	0%	Width	1%
	Border	Luma	100%	Sat	80%	Hue	0
	Position	X	0%	Y	0%		

	<b>Matte</b>	<b>Luma</b> 100%	<b>Sat</b> 80%	<b>Hue</b> 0	

### Basic mode

<b>Start</b>	<b>Transition</b>	<b>M/E</b> 15	<b>DSK</b> 15	<b>FTB</b> 60
	<b>Wipe Effects</b>	<b>Wipe</b> 1	<b>Soft</b> 0%	<b>Width</b> 1%

### Transition

The **Transition** option allows the user to set the transition duration, in frames, for switching the PGM view when using the **AUTO**, **DSK** and **FTB** buttons.

For example, if the **M/E** is set to a value of 50, then the transition will take effect over a period of 50 frames or roughly 2 seconds. When the **AUTO button** is pressed, the transition will take the current M/E value defined by the user setting.

### Type

The HS-3200 provides three major types of transition effect, which are **DVE (3D)**, **MIX**, **WIPE (2D)** and **Clip**. Please note in addition to selecting the transition effect on the OSD menu, you can also press **MIX button**, **WIPE/DVE button** or **CLIP button** to enable the respective transition effects.

- If **DVE** is selected, select the corresponding 3D WIPE effect by pressing the DVE buttons on the control panel. These DVE buttons are:  
**DVE 1:** Wipe from left to right  
**DVE 2:** Wipe from top to bottom  
**DVE 3:** Wipe from right to left
- For **MIX** effect, set the transition time in “**Start → Transition → M/E.**”
- For **WIPE** effect, set the relevant WIPE settings in “**Start → WIPE Effects.**”
- For **Clip**, also known as the **Stinger Effect**, please first load the clip in “**Files → Clip.**”

### Wipe Effects

In “**WIPE Effects,**” the user is allowed to select the Wipe style and configure the wipe’s border softness and width.

- **Wipe** – Selection of a WIPE effect from a set of 32 WIPE transition effects.
- **Soft** – A low value results in a solid edge and a high value gives a soft diffused edge.
- **Width** – A low value results in a thin edge and a high value gives a wide edge.

### WIPE Border

In this sub-option, the user will be allowed to fine-tune the border color by adjusting the **Luma**, **Saturation** and **Hue** values.

**Note:** Enable the **WIPE border** by setting the border width (**Width**) to a value greater than 0. The **WIPE border** is disabled when the border width is set to 0.

## Position

Position allows the user to adjust the center position of certain wipes (e.g Circle & Elipse). **X** represents the horizontal position and **Y** is the vertical position.

### Horizontal Position (X)

Positive value moves the wipe center to the right.

Negative value moves the wipe center to the left.

Zero value positions the wipe center at the screen center

### Vertical Position (Y)

Positive value moves the wipe center up.

Negative value moves the wipe center down.

Zero value positions the wipe center at the screen center.

## Matte

The user can open the Matte view by pressing the **BLK/MATTE** button of the **Program** and **Preset** button rows. The color of the Matte is configurable in this sub-option by adjusting **Luma**, **Saturation** and **Hue**.

For **Hue** value, **Red** is 0, **Green** is approximately 120 and **Blue** is approximately 240. For secondary colors, **Yellow** is approximately 60, **Cyan** is approximately 180 and **Violet** is approximately 300.

The **Sat** or **Saturation value** refers to the intensity of the color selected in **Hue**. As the saturation increases, the color appears to be more pure. As the saturation decreases, the color appears to be more washed-out or pale.

The **Luma value** relates to how bright or dark the selected color or hue is. The higher the **Luma** value, the brighter the color selected in **Hue**.

## 4.2 Keyer

Keyer of the HS-3200 provides the user with the capability of image keying. In this option menu, the user will be able to configure the eight keyers available on the HS-3200.

### Advanced mode

Keyer	Keyer	Key 4	Normal	
	<b>Keyer Ctrl</b>	Chroma	Self	<b>Opac</b> 100%
		<b>Lift</b> 0%	<b>Gain</b> 1.0	<b>Invert</b> Off
	<b>Key Source</b>	<b>Input 4</b>	<b>Fill</b> Black	
	<b>Mask</b>	<b>Left</b> 0%	<b>Right</b> 0%	
		<b>Top</b> 0%	<b>Bot</b> 0%	

### Keyer

The 8 keyer options are **Key 1**, **Key 2**, **Key 3**, **Key 4**, **DSK 1**, **DSK 2**, **Flex Key 1** and **Flex Key 2**.



Key 1 – 4 are usually configured for luma and chroma keyers so select **Self** since only one source is enabled for such keyers.

The DSK keyer options are **Linear** and **Luma**. After the DSK keyer option is chosen, select **Self** if only one source is enabled for DSK keyer, which is the Key source. Select **Split** if two sources are enabled for the DSK keyer, which are Fill and Key sources. An example of a Linear DSK self setup could be using an HDMI input from a Windows laptop running Datavideo's CG-250 Character Generator software; see [Character Generator](#) for more information.

Once configured, the keyers can be activated by pressing the corresponding keyer buttons on the switcher's control panel except Flex Key 1 and Flex Key 2 which are enabled in the Flex Src sub menu. Please note that the Flex Keys, once configured and enabled, are displayed along with the Flex Screen. See [Flex Src](#) → [Keyer](#) for instructions on setting Flex Keys.

Select **Fine** if you require high keying quality and **Normal** for original keying quality.

### **Keyer Control**

There are three keying modes available: **Linear**, **Luma**, and **Chroma**.

**Please note that if you select Full, the keying effect will be disabled, keeping the original source image. For example, if you select Full → PIP, the keying effect will not be applied to the PIP image source.**

**Linear** keying mode is usually chosen for sharp images as it is usually used in professional graphic design. For non-sharp images, please select **Luma** keying for basic text images. **Chroma** keying mode allows you to remove the green or blue backdrop from the image and is usually used in overlapping talent on a background image.

After the keying mode is chosen, select **Self** if only one source is required for the keyer, which is Key source. Select **Split** if two sources are required for the keyer, which are Key and Fill sources. You can also select **P-in-P** to apply the keying effect to the PIP window.

If **Luma** keying is selected, the key image is configured by adjusting **lift**, **gain** and **opacity** parameters.

**Lift** adjusts the dark/black areas of the key image. **Reducing the value of Lift** will make dark areas of the key image more transparent. The background image will be showing only through the transparent areas.

**Gain** adjusts the light/white areas of the key image. **Increasing the value of Gain** will make light areas of the key image more solid. The background image will be showing only through the transparent areas.

**Opac** adjusts the transparency of the overall foreground key image. **Increasing the value of Opacity** will make the overall key image less transparent.

**Please note:**

**If Chroma is selected, adjust the Chroma Keyer parameters in the Chroma sub menu.**

If P-in-P is selected, adjust its parameters in the P-in-P sub menu.

For example, if the user selects **Key 1** → **Chroma** → **P-in-P**, you will then be able to apply the chroma key effect to the P-in-P window by configuring the respective chroma keyer parameters in the **Chroma** sub menu.

In the example below, after Keyer 1 is configured, by pressing the **Key 1 PGM or PVW** button on the switcher’s control panel, the user will thus be able to enable the P-in-P window on the respective display monitor with the chroma key effect applied.

Keyer	Keyer	Key 1	Normal	
	<b>Keyer Ctrl</b>	Chroma	Self	<b>Opac</b> 100%
		<b>Lift</b> 0%	<b>Gain</b> 1.0	<b>Invert</b> Off
	<b>Key Source</b>	<b>Input 1</b>	<b>Fill</b> Black	
	<b>Mask</b>	<b>Left</b> 0%	<b>Right</b> 0%	
		<b>Top</b> 0%	<b>Bot</b> 0%	

### Key Source

This option allows the user to assign the key source; various options are listed below:

- Bars: Color bars
- Matte: A configurable color screen and the Matte value can be set in **Matte** option of the **Start** menu
- Flex Src 1/2: Selected Flex source ([Flex Src](#) option menu)
- Still 1/2: Still picture loaded to Still 1/2 buttons
- Input 12: Image source loaded to input button 12
- Input 11: Image source loaded to input button 11
- Input 10: Image source loaded to input button 10
- Input 9: Image source loaded to input button 9
- Input 8: Image source loaded to input button 8
- Input 7: Image source loaded to input button 7
- Input 6: Image source loaded to input button 6
- Input 5: Image source loaded to input button 5
- Input 4: Image source loaded to input button 4
- Input 3: Image source loaded to input button 3
- Input 2: Image source loaded to input button 2
- Input 1: Image source loaded to input button 1
- Black: Black Screen

### Fill Source

This sub-option allows the user to assign the fill source; various options are listed below:

- Bars: Color bars
- Matte: A configurable color screen and the Matte value can be set in **Matte** option of the **Start** menu

- Flex Src 1/2: Selected Flex source ([Flex Src](#) option menu)
- Still 1/2: Still picture loaded to Still 1/2 buttons
- Input 12: Image source loaded to input button 12
- Input 11: Image source loaded to input button 11
- Input 10: Image source loaded to input button 10
- Input 9: Image source loaded to input button 9
- Input 8: Image source loaded to input button 8
- Input 7: Image source loaded to input button 7
- Input 6: Image source loaded to input button 6
- Input 5: Image source loaded to input button 5
- Input 4: Image source loaded to input button 4
- Input 3: Image source loaded to input button 3
- Input 2: Image source loaded to input button 2
- Input 1: Image source loaded to input button 1
- Black: Black Screen

### ***Invert***

Configure the luma key color

OFF: Luma key removes black background by default.

ON: Luma key removes white background after **INVERT** is turned **ON**.

### ***Mask***

The Mask feature basically shrinks the source image by removing borders of the final image. In this option, the user is allowed to configure the Mask in chroma, luma or linear mode by adjusting **Left**, **Right**, **Top** and **Bottom** parameters.

- **Left** – Left sets the left edge of the keyer mask.
- **Right** – Right sets the right edge of the keyer mask.
- **Top** – Top sets the top edge of the keyer mask.
- **Bottom** – Bottom sets the bottom edge of the keyer mask.

## **4.3 Chroma**

The Chroma Keyer removes the green background of the key image. If **Chroma** is selected in **Keyer**, this option menu allows you to configure the corresponding parameters.

### **Advanced mode options**

<b>Chroma</b>	<b>Keyer</b>	<b>Key 4</b>	<b>Normal</b>		
	<b>Key Source</b>	<b>Input 4</b>			
	<b>Key Tie</b>	<b>On</b>	<b>Input 6</b>		
	<b>CK Setup</b>	<b>CK Auto</b>	<b>Hue</b> 110	<b>Luma</b> 80%	
		<b>K Range</b> 160	<b>K Fgnd</b> 10%	<b>K Bgnd</b> 20%	
		<b>Hi-Light</b> 0%	<b>Lo-Light</b> 0%	<b>Bg-Supp</b> OFF	
		<b>Left</b> 0%	<b>Right</b> 0%	<b>Soft</b> 0%	

	<b>Mask</b>	<b>Left</b>	0%	<b>Right</b>	0%	
		<b>Top</b>	0%	<b>Bot</b>	0%	

### Keyer

First of all, select the **Keyer (Key 1, Key 2, Key 3, Key 4, DSK 1, DSK 2, Flex Key 1 or Flex Key 2)** that you would like to apply the chroma key effect to and then select one **Key Source** from all available Key Sources listed below.

Select **Fine** if you require high keying quality and **Normal** for original keying quality.

### Key Source

This sub-option allows the user to assign a key source to the keyer selected; various options are listed below:

- Bars: Color bars
- Matte: A configurable color screen and the Matte value can be set in **Matte** option of the **Start** menu
- Flex Src 1/2: Selected Flex source ([Flex Src](#) option menu)
- Still 1/2: Still picture loaded to Still 1/2 buttons
- Input 12: Image source loaded to input button 12
- Input 11: Image source loaded to input button 11
- Input 10: Image source loaded to input button 10
- Input 9: Image source loaded to input button 9
- Input 8: Image source loaded to input button 8
- Input 7: Image source loaded to input button 7
- Input 6: Image source loaded to input button 6
- Input 5: Image source loaded to input button 5
- Input 4: Image source loaded to input button 4
- Input 3: Image source loaded to input button 3
- Input 2: Image source loaded to input button 2
- Input 1: Image source loaded to input button 1
- Black: Black Screen

### Key Tie

Key tie is a feature that allows you to overlap a foreground image on a background image. The key tie image can then be opened by pressing the input button to which the background image is assigned. Note that the keyer button will be disabled if key tie is enabled for the corresponding keyer. Outlined below are steps to set key tie with the chroma keyer.

1. First, in the Keyer menu, select the keyer and set it to Chroma. We used Key 1 in this example.

<b>Keyer</b>	<b>Keyer</b>	<b>Key 1</b>	<b>Normal</b>	
	<b>Keyer Ctrl</b>	<b>Chroma</b>	<b>Self</b>	

		<b>Lift</b> 0%	<b>Gain</b> 1.0	<b>Opac</b> 100%
	<b>Key Source</b>	<b>Input 3</b>	<b>Fill</b> <b>Input 12</b>	<b>Invert</b> Off
	<b>Mask</b>	<b>Left</b> 0%	<b>Right</b> 0%	
		<b>Top</b> 0%	<b>Bot</b> 0%	

- Open the Chroma menu and select Key 1. Assign a foreground image to the Key Source (the foreground image is usually a person or an object against a green backdrop). In this case, it's Input 3.

Chroma	Keyer	Key 1	Normal	
	<b>Key Source</b>	<b>Input 3</b>		
	<b>Key Tie</b>	<b>Off</b>	Off	
	<b>CK Setup</b>	<b>CK Auto</b>	<b>Hue</b> 110	<b>Luma</b> 80%
		<b>K Range</b> 160	<b>K Fgnd</b> 10%	<b>K Bgnd</b> 20%
		<b>Hi-Light</b> 0%	<b>Lo-Light</b> 0%	<b>Bg-Supp</b> OFF
		<b>Left</b> 0%	<b>Right</b> 0%	<b>Soft</b> 0%
	<b>Mask</b>	<b>Left</b> 0%	<b>Right</b> 0%	
		<b>Top</b> 0%	<b>Bot</b> 0%	

- Enable Key Tie and on the right, select a background image.

Chroma	Keyer	Key 1	Normal	
	<b>Key Source</b>	<b>Input 3</b>		
	<b>Key Tie</b>	<b>On</b>	<b>Input 6</b>	
	<b>CK Setup</b>	<b>CK Auto</b>	<b>Hue</b> 110	<b>Luma</b> 80%
		<b>K Range</b> 160	<b>K Fgnd</b> 10%	<b>K Bgnd</b> 20%
		<b>Hi-Light</b> 0%	<b>Lo-Light</b> 0%	<b>Bg-Supp</b> OFF
		<b>Left</b> 0%	<b>Right</b> 0%	<b>Soft</b> 0%
	<b>Mask</b>	<b>Left</b> 0%	<b>Right</b> 0%	
		<b>Top</b> 0%	<b>Bot</b> 0%	

- After key tie is configured, to open the key tie image, simply press the input button of the background image selected at Step 3. In this example, input 6 is selected as the background so press button 6 on either the Preset or Program row to open the key tie image on the respective views.

Below are available sources of the background image:

- Still 1/2
- Input 1–12
- Off

**Note: You will not be able to use the keyer button once key tie is enabled. Use the input button that is assigned to the background image to open the key tie image.**

### **CK Setup**

In this sub-option, the user will be able to find all the parameters needed to perform chromakeying of the green or blue backdrop.

**CK Auto:** This function automatically calculates the best Hue & Luma values for the current Keyer source. After applying the CK Auto effect, the result can be fine-tuned by adjusting the Luma and Hue values.

**Hue:** This parameter adjusts the color of the chroma key. A typical green screen value will be around 120. Blue screen value will be around 240.

**Luma:** This parameter adjusts the luma value of the chroma key

**K Range (Key Range):** Key Acceptance sets the range of hues or colors (0 – 360 degrees) that closely match the background color to be keyed. The user can start with a value of 120 degrees and this value can be fine-tuned up or down depending on the setup of the green or blue screen studio.

**K Fgnd (Key Foreground):** **Key Foreground** adjusts the performance of the chroma key in light or white areas. Apply more **Key Foreground** if the light areas are becoming too transparent.

**K Bgnd (Key Background):** **Key Background** adjusts the performance of the chroma key in dark or black areas. Apply more **Key Background** if the dark areas are becoming too transparent.

**Hi-Light:** Hi-light boosts the foreground key in high luminance area.

**Lo-Light:** Lo-light boosts the foreground key in low luminance area.

**Bg-Supp: Background Suppress** removes the Luma (Brightness) of the background from the final image. **Bg-Supp** turns ON/OFF background suppression.

**Left:** Trims the left edge of the key object.

**Right:** Trims the right edge of the key object.

**Soft:** Determines the distinctiveness of key edge

### **Mask**

The Mask feature basically shrinks the camera image by removing the borders from the final image. This feature allows the user to configure the Mask in chroma, luma or linear mode.

- **Left** – Left sets the left edge of the keyer mask.
- **Right** – Right sets the right edge of the keyer mask.
- **Top** – Top sets the top edge of the keyer mask.
- **Bottom** – Bottom sets the bottom edge of the keyer mask.

## **4.4 P-In-P**

The **P-in-P** option allows the user to adjust all related P-in-P parameters. Use this option to configure your PIP window if **P-in-P** is selected in the **Keyer Ctrl** sub-option of the **Keyer** option.

**Note:** The P-in-P image source can only be selected in **Key Source** option of the **Keyer Sub Menu**.

## Advanced mode options

P-in-P	Keyer	Key 1		Fine	Normal
	<b>Position</b>	<b>X</b>	-20%	<b>Y</b>	10%
	<b>Border</b>	<b>Normal</b>			
		<b>Luma</b>	100%	<b>Sat</b>	80%
		<b>Width</b>	2%	<b>Soft</b>	0%
	<b>Shade Matte</b>	<b>Luma</b>	100%	<b>Sat</b>	80%
		<b>Shade Soft</b>	2%	<b>Shade Pos</b>	50
	<b>Crop</b>	<b>Left</b>	0%	<b>Right</b>	0%
		<b>Top</b>	0%	<b>Bot</b>	0%
				<b>Size</b>	40%
				<b>Hue</b>	0
				<b>Opac</b>	100%
				<b>Hue</b>	60
				<b>Direction</b>	35
				<b>Size</b>	0%
				<b>Soft</b>	0%

### Keyer

In this sub-option, the user will be allowed to select and configure the PIP window from the list below. Please note that Keyers 1-4 are active for PIP configuration only if P-in-P is selected in the Keyer sub-menu for the respective keyer.

- Key 1
- Key 2
- Key 3
- Key 4
- Flex PinP 1
- Flex PinP 2
- Flex PinP 3
- Flex PinP 4

### Position

The user can adjust the P-in-P window position by adjusting values of **X**, **Y** and **SIZE**, where X is the horizontal position, Y is the vertical position and Size is the PIP screen size.

**X-Value**     Positive value: position the P-in-P window to the right.  
 Negative value: position the P-in-P window to the left.  
 Zero value: Position the P-in-P window at the center.

**Y-Value**     Positive value: move the P-in-P window up.  
 Negative value: move the P-in-P window down.  
 Zero value: Position the P-in-P window at the center.

**Size**           Ranges from 0 to 100 with 1% being the smallest and 100 being the largest. So 50% would represent a P-in-P window which is half the size of the background image. 100% would see the PIP image totally cover the background image unless offset to one side.

## ***Fine***

Once enabled, you will then be able to fine tune the position of the P-in-P window by adjusting **X** and **Y** vales as well as the **Size**. This feature allows you to move the P-in-P window more precisely to the desired location and adjust its size.

## ***Border***

The user is also allowed to add borders to the PIP window and the HS-3200 offers various border styles listed as follows:

- Border Off
- Normal
- Shaded\*
- 3D Bevel\*\*
- Bevel Shaded\*
- Dual Bevel\*\*
- Bevel Flat\*\*
- Flat Bevel\*\*
- 3D Glass\*\*
- Dual Glass\*\*
- Glass Flat\*\*
- Flat Glass\*\*
- Circle\*\*
- Circle Shaded\*
- Rounded\*\*
- Rounded Shaded\*

***\*See Shade Matte/Hue for dual color border setting.***

***\*\*See Shade Matte/Direction for border shadow setting.***

To turn the Border off, simply select the option “Border OFF.”

In addition to assigning a style to the border, the user is also allowed to set border color by adjusting **Luma**, **Saturation** and **Hue** values. **Luma** and **Saturation** range from 0 to 100%. **Hue** value ranges from 0 to 355. The borders can also be widened or narrowed by adjusting **Width**. Please note that a width of zero (0) will turn the PIP border off.

**Opac** adjusts the transparency of the border, ranging from 0% to 100%

**Softness** defines the distinctiveness of the border edge. A low value results in a solid border edge and a high value gives a soft diffused border.

## ***Shade Matte (Dual Color Border)***

In order for the **Shade** effect to work, **Shaded Border (Dual Color)** must be selected first as the **Border** – see the previous section **Border**. Please note that Shade Matte determines the inner border and the boundary between the normal border matte and the shade matte can be determined by adjusting the **Shade Position** parameter.



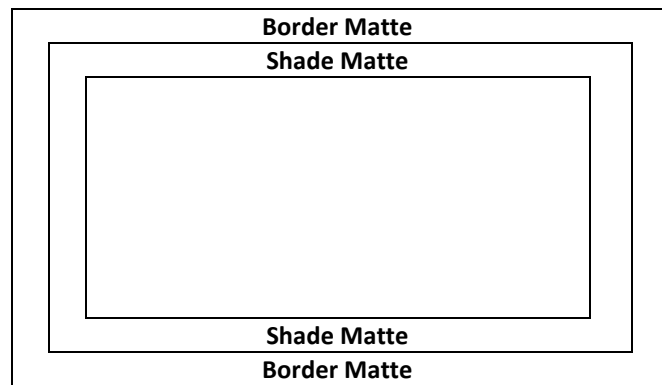

### **Luma, Sat and Hue**

The color of the **Shade Matte** can also be controlled by adjusting the **Hue, Sat** and **Luma** values.

For **Hue** value, **Red** is 0, **Green** is approximately 120 and **Blue** is approximately 240. For secondary colors, **Yellow** is approximately 60, **Cyan** is approximately 180 and **Violet** is approximately 300.

The **Sat** or **Saturation value** refers to the intensity of the color selected in **Hue**. As the saturation increases, the color appears to be more pure. As the saturation decreases, the color appears to be more washed-out or pale.

The **Luma value** relates to how bright or dark the selected color or hue is. The higher the **Luma** value, the brighter the color selected in **Hue**.

### **Shade Softness, Shade Position and Direction**

The **Shade Matte** can be further configured by adjusting its **softness (Shade Soft)** and **width (Shade Pos)**.

#### **Shade Soft**

This blurs or softens the **Shade Matte** area.

#### **Shade Position**

The position of the boundary line between **Shade Matte** and **Border Matte** is controlled by the **Shade Pos** value.

Increasing this value moves the boundary line such that the **Shade Matte** occupies less of the width of the border. Decreasing this value moves the boundary line such that the **Shade Matte** occupies more of the overall border width. When this value is 0, the **Shade Matte** occupies all of the border width.

**Note: You will see dual colors only if options “Shaded” and “Bevel Shaded” are selected.**

#### **Direction**

Direction sets the direction of the light source with the value of parameter ranging from 0 to 355. The default is 35, which indicates a direction of North East. You will see the border’s color shadow changes as the Direction value is changed. The directions that specific parameter values correspond to are listed as follows:

- 0: North
- 90: East
- 180: South
- 270: West

### **Crop**

The PIP image crop can be adjusted by modifying the following parameters:

- **Left** – Adjusts the position of the left edge of the PIP image.
- **Right** – Adjusts the position of the right edge of the PIP image.
- **Size** – Adjusts the PIP image crop size.
- **Top** – Adjusts the position of the top edge of the PIP image.
- **Bot** – Adjusts the position of the bottom edge of the PIP image.
- **Soft** – Adjusts the crop edge transparency.

**Note: You will sometimes see black thin lines on your PIP image after setting the PIP border to Normal with a border width of zero. This is caused by using an image that differs from its original size. To remove these lines, turn the border off or use the crop function to shrink the image until the lines disappear.**

## **4.5 Flex Src**

The Flex™ output allows the user to show a variety of sources at the same time. These image sources are fed as one combined image to the Program and Preset outputs.

The Flex™ output consists of one background image and four smaller source images overlapped on the background image in four separate individual PIP windows.

The HS-3200 offers the user two Flex™ outputs, which can be selected in “**Flex Src**” as shown in the Flex Src sub menu below. After selecting the Flex output, you can then start setting the source of input for each FLEX window as detailed in the next section.

<b>Flex Src</b>	<b>Flex Src</b>	Flex Src 1		
	<b>Flex Src Bgnd</b>	Black		
	<b>P-in-P 1 Src</b>	Black	<b>Enable</b>	On
	<b>P-in-P 2 Src</b>	Black	<b>Enable</b>	On
	<b>P-in-P 3 Src</b>	Black	<b>Enable</b>	On
	<b>P-in-P 4 Src</b>	Black	<b>Enable</b>	On
	<b>Keyer 1</b>	Input 1	Input 2	<b>Enable</b> On
	<b>Flex Preset</b>	<b>Preset 1</b>	<b>Preset 2</b>	<b>Preset 3</b>
		<b>Preset 4</b>	<b>Preset 5</b>	<b>Preset 6</b>

### **Flex Screen**

To set the source of input for the respective FLEX windows, open the OSD menu and select FLEX Src. On the sub-menu that opens, you will be able to see the following options allowing you to select the image sources to be displayed in the FLEX windows.

- **Flex Src Bgnd:** The background image is the image on which the FLEX windows are stacked.

- P-in-P 1 Src selects the image displayed in FLEX window 1.
- P-in-P 2 Src selects the image displayed in FLEX window 2.
- P-in-P 3 Src selects the image displayed in FLEX window 3.
- P-in-P 4 Src selects the image displayed in FLEX window 4.

The available sources of inputs are listed as follows:

- Black: Black Screen
- Input 1: Image source loaded to input button 1
- Input 2: Image source loaded to input button 2
- Input 3: Image source loaded to input button 3
- Input 4: Image source loaded to input button 4
- Input 5: Image source loaded to input button 5
- Input 6: Image source loaded to input button 6
- Input 7: Image source loaded to input button 7
- Input 8: Image source loaded to input button 8
- Input 9: Image source loaded to input button 9
- Input 10: Image source loaded to input button 10
- Input 11: Image source loaded to input button 11
- Input 12: Image source loaded to input button 12
- Still 1: Still picture loaded to Still 1 button
- Still 2: Still picture loaded to Still 2 button
- Matte: A configurable color screen and the Matte value can be set in **Matte** option of the **Start** menu
- Bars: Color Bars

### Keyer

The Flex Keyer can be set to **Chroma**, **Luma** or **Downstream keyer**. In the **Keyer** sub menu, first select the **Flex Key** with respect to the **Flex Source** selected in “**Flex Src**”. Then if a Chroma or Luma Self key setup is selected, only one source is enabled for the keyer, which is key source. If you’ve selected a DSK Split setup, then two sources should be enabled for the DSK keyer, which are Key and Fill sources.

In **Keyer** of the **Flex Src** sub menu, the first field corresponds to the key source and the second field selects the fill source.

P-in-P 3 Src	Black	Enable	On
P-in-P 4 Src	Black	Enable	On
Keyer 1	Input 1	Input 2	Enable On
Flex Preset	Preset 1	Preset 2	Preset 3
	Preset 4	Preset 5	Preset 6

First field = Key source

First field = Fill source

If you’ve selected **Chroma key setup**, the keyer can be configured in [Chroma](#) sub menu.

If you’ve selected **Luma key setup**, adjust Lift, Gain and Opac in [Keyer](#) sub menu.

For a Linear DSK self setup, a good example could be using an HDMI input from a Windows laptop that is running Datavideo's CG-250 Character Generator Software; see [Character Generator](#) for more information.

Key source and Fill source will be required for a DSK split setup. The steps outlined below will guide you through the configuration process of such.

### System Hardware Setup

1. Connect the laptop to the PC IN HDMI port of the TC-200 Title Creator using an HDMI cable.
2. Open CG-250 on the laptop and create a CG image that can then be sent to the HS-3200 via TC-200.
3. At the rear of the HS-3200, the two SDI output ports of the TC-200, Key Source and Fill Source, are respectively connected to the HS-3200's SDI 1 and SDI 2 inputs.
4. Switch ON the HS-3200's power button and after the boot up is complete, the Multiview should be displayed on the connected monitor.

### Menu Settings

5. On the Multiview, Input 1 window displays the Key Source, Input 2 window displays the Fill Source.
6. Follow the menu path [Keyer](#) → [Keyer](#) and select either **Flex Key 1** or **2** depending on the Flex screen selected in [Flex Src](#).
7. Follow the menu path [Keyer](#) → [Keyer Ctrl](#) and set the **Flex Key** to a **linear** or **luma DSK split** keyer.
8. Follow the menu path [Flex Src](#) → **Keyer1 (Keyer2)** and set CG Overlay inputs by selecting **Input 1 (Key)** in the first field and **Input 2 (Fill)** in the second field.

Flex Src	Flex Src	Flex Src 1		
	<b>Flex Src Bgnd</b>	Black		
	<b>P-in-P 1 Src</b>	Black	<b>Enable</b>	On
	<b>P-in-P 2 Src</b>	Black	<b>Enable</b>	On
	<b>P-in-P 3 Src</b>	Black	<b>Enable</b>	On
	<b>P-in-P 4 Src</b>	Black	<b>Enable</b>	On
	<b>Keyer 1</b>	Input 1	Input 2	<b>Enable</b> On
	<b>Flex Preset</b>	<b>Preset 1</b>	<b>Preset 2</b>	<b>Preset 3</b>
		<b>Preset 4</b>	<b>Preset 5</b>	<b>Preset 6</b>

After the keyer is configured, enable the keyer and on the switcher's control panel, press and hold the **SHIFT** button then press the **3/FLEX** button on either the Preset or Program row to view the Flex screen with CG enabled.

### ***Flex Preset***

The HS-3200 offers the user three FLEX Screen layouts. The respective **default** layouts are shown in the diagrams below.

#### **Preset 1**

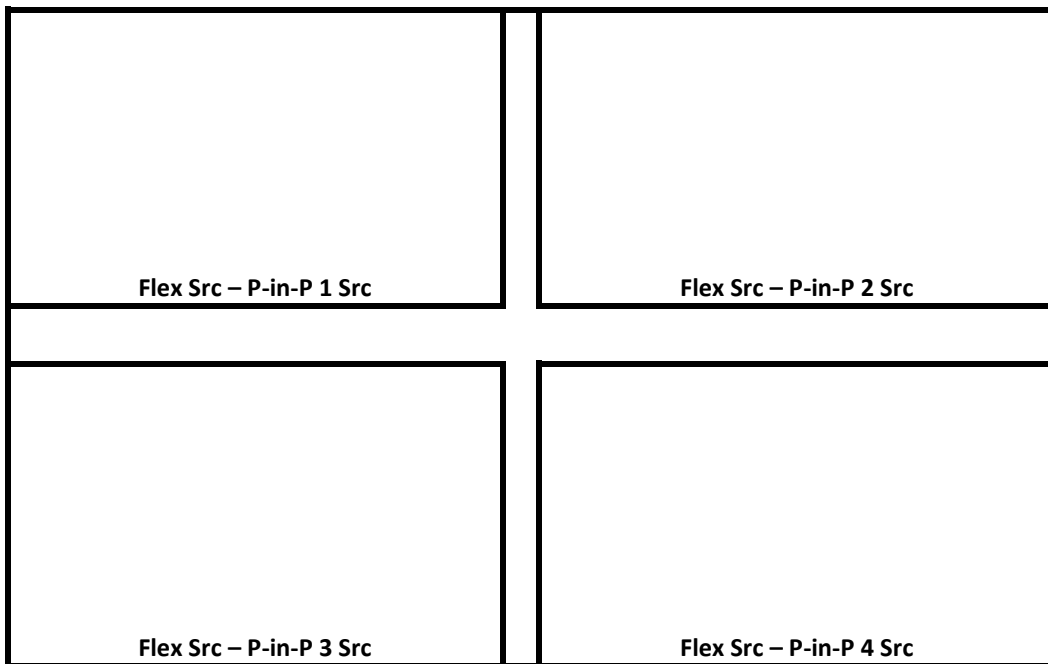

#### **Preset 2**

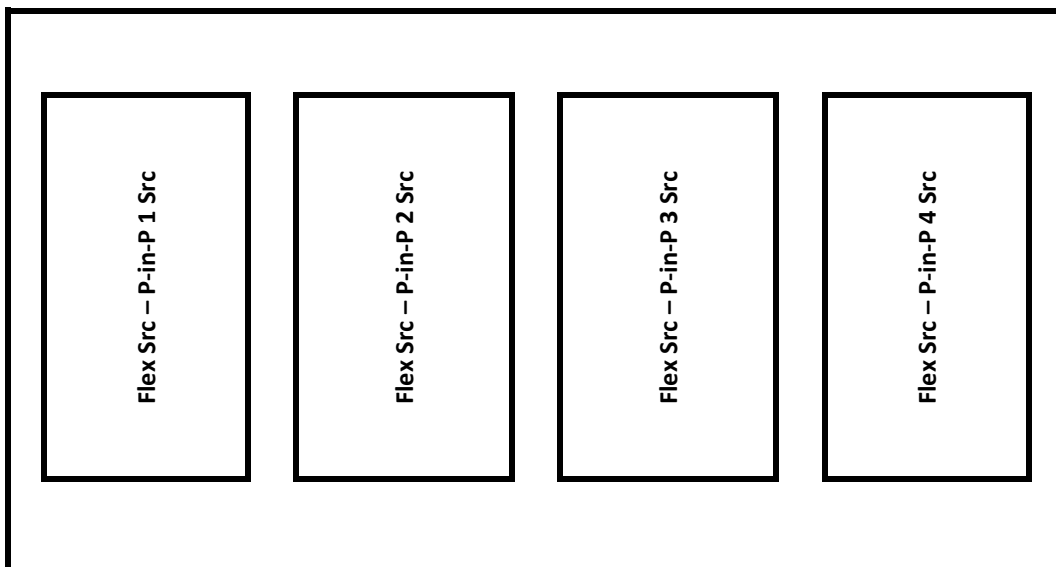

### Preset 3

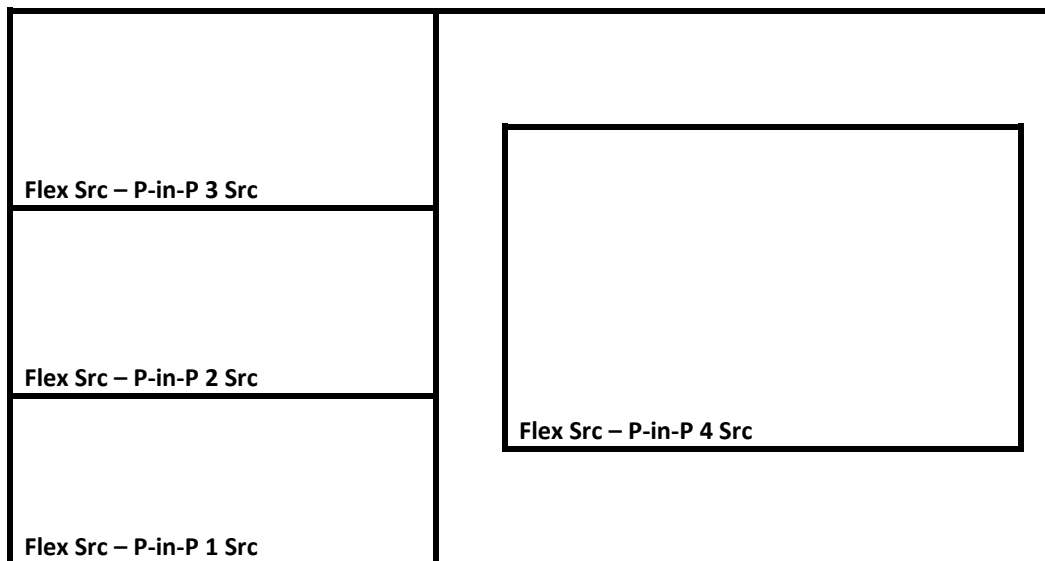

**Note: Presets 4 to 6 are reserved for future developments.**

Please note that positions of these PIP windows on the FLEX screen can be changed by adjusting the **x-y coordinates** in the **P-in-P** option. In addition, the user is also allowed to adjust the size of the FLEX window, enable/disable the window's border, set the border color, and crop the window image.

After the FLEX source is properly configured, the user can activate **Flex Src 1** on either the Program or Preset screen by pressing the **SHIFT** key followed by the **3/FLEX** button (the button should illuminate blue) along the Program or Preset row. Press the **3/FLEX** button (the button should illuminate orange) again while holding down the **SHIFT** key to activate **Flex Src 2**.

Alternatively, press the **BLK/MATTE** button which should turn blue, then press the **3/FLEX** button to activate **Flex Src 1** (3/FLEX button flashing blue) and again to activate **Flex Src 2** (3/FLEX button flashing red).

Note that the Flex Src window has an allowable size of up to 1080p full screen. If exceeded, one of the Flex Src windows will not be able to display the image correctly.

## 4.6 Inputs

This feature allows the user to select the mode of the selected input and then configure the input color by adjusting its **Black Level**, **White Clip** and **Chroma Gain** parameters. In addition, the Crosspoint function allows the user to shuffle contents of Inputs 1-12 without changing physical connections at the back of the machine.

### Advanced mode options

Inputs	Input	Input 9	Mode	Live	Mode	Zoom Md
		<b>Zoom</b> 100%	<b>X</b>	0%	<b>Y</b>	0%
	<b>Proc Amp</b>	<b>Black</b> 0%	<b>White</b>	100%	<b>Chrom</b>	1.0

	<b>Audio</b>	<b>Gain</b> 0 dB	<b>Delay</b> 0 ms	
	<b>Crosspoint</b>	<b>Input 9</b>		
	<b>Audio XPT</b>	<b>Off</b>		

## ***Input***

In this option, you will be allowed to set the mode of display in the respective Input windows of the Multiview display. First select the input that you would like to configure and then for each selected input, set the mode of input by selecting one of the modes **from the first mode option**:

- Still – Displays the still picture loaded into Inputs 1-12 in the respective input window.
- Freeze – Freezes the current video played in the Input window.
- Live – Live view or video display in the Input window.

## **Mode of Operation**

The second mode option allows you to select the mode of operation for the selected input.

**Zoom Mode:** This mode allows you to enlarge or shrink the selected input image. Select Zoom if you want to simultaneously adjust your image size horizontally and vertically. To adjust the image size horizontally only, simply change the X value and to adjust the image size vertically only, simply change the Y value.

**TC-200 Mode:** The TC-200 is a character generator built into the switcher to allow keying of CG text or graphics over the live video. Built-in TC-200s are available on Inputs 9-12 only.

**Please note that the following hardware restrictions apply when using this feature.**

- The built-in title overlay system (**TC-200**) works better with ATI and Intel VGA graphics cards.
- Compatibility issue such as color difference may occur when used with NVIDIA graphics cards.

First ensure that your input image or video resolution matches the switcher’s resolution set in [OSD menu](#) → [Setup](#) → [Standard](#), then follow the steps below to set up your CG text or graphics after TC-200 mode is enabled on the selected input (Inputs 9-12).

1. Connect the laptop to one of the HDMI ports of the HS-3200 switcher using an HDMI cable. In this example, we will be using HDMI port 9 for illustration purpose.
2. Open CG-250 on the laptop and create a CG image that can then be sent to the HS-3200 via the built-in TC-200.
3. Switch ON the HS-3200’s power button and after the boot up is complete, the Multiview should be displayed on the connected monitor.
4. On the Multiview, Input 9 window should display the CG image.
5. Press the “**MENU**” button on the HS-3200’s control panel to open the OSD menu on the Multiview display and then select the “**Inputs**” sub menu.

- Select “**Input 9**” from the **Input** option and enable TC-200 mode by turning on TC-200 Md.

Inputs	Input	Input 9	Mode	Still	Mode	TC-200 Md
	<b>Proc Amp</b>	<b>Black</b> 0%	<b>White</b> 100%		<b>Chrom</b>	1.0
	<b>Audio</b>	<b>Gain</b> 0 dB	<b>Delay</b> 0 ms			
	<b>Crosspoint</b>	<b>Input 9</b>				
	<b>Audio XPT</b>	<b>Off</b>				

- Move to the “**Keyer**” sub menu.
- Select “**DSK 1 or 2**” from the **Keyer** option and set Key and Fill Sources to Input 9.

Keyer	Keyer	DSK1	Normal	
	<b>Keyer Ctrl</b>	Linear	Split	<b>Opac</b> 100%
		<b>Lift</b> 0%	<b>Gain</b> 1.0	<b>Invert</b> Off
	<b>Key Source</b>	<b>Input 9</b>	<b>Fill</b> <b>Input 9</b>	
	<b>Mask</b>	<b>Left</b> 0%	<b>Right</b> 0%	
		<b>Top</b> 0%	<b>Bot</b> 0%	

- Locate DSK buttons on the switcher’s control panel then depending on the settings selected at Step 8, press DSK 1 or 2 button to open your CG graphics on either of the preview and program windows or both.

### **Proc Amp**

Proc Amp allows the user to configure the input color by adjusting its Black Level (0 – 100%), White Clip (0 – 100%) and Chroma Gain (0 – 16) parameters.

### **Audio**

**Gain (0 – 24 dB):** adjustment of the input audio volume for a particular selected video input.

**Delay (0 – 340 ms):** sets the delay of the audio component of a particular selected video input.

### **Crosspoint**

The crosspoint function allows the user to shuffle the contents of Inputs 1-12 without changing the physical connections at the back of the machine. For example, the user is allowed to assign the input 2 video source to input 1, after which the input 2 video will be displayed on the input 1 window. Select OFF if you would like to disable the input port.

- Input 1-12
- OFF



## Audio XPT

The Audio XPT feature allows the user to associate the audio component of any input source to any of the input buttons (1 – 12), thus cross assigning audio input channels to program/preset row buttons. Available options are listed as follows:

- Input 1-12
- External
- Follow

“**External**” selects audio source from AUDIO IN ports.

Select “**Follow**” to set the audio to Audio-Follow-Video mode in which the PGM audio is played via **AUDIO OUT** port. Please note that there will be no audio delay.

## 4.7 Outputs

This option allows the user to configure various output settings such as video output, Tally mode and GPI connection.

### Advanced mode

Outputs	Output	Sdi 1	Input 1	Sdi 2	Input 2	Sdi 3	Input 3
		Sdi 4	Input 4	Sdi 5	Input 5		
		HDMI	Pgm				
	<b>Multiviewer</b>	<b>AutoNum</b>	<b>Off</b>	<b>Label Inf</b>	<b>Off</b>	<b>Trns Lab</b>	<b>Off</b>
		<b>MV1</b>	Preset 3	<b>MV2</b>	Preset 1	<b>L: PVW</b>	<b>R: PGM</b>
	<b>Tally Mode</b>	Normal					
	<b>GPI Out</b>	Off		<b>Mode</b>	Pulse	<b>Width</b>	1
		Input 1		<b>Delay</b>	0		

### Basic mode

Outputs	Output	Sdi 1	Input 1	Sdi 2	Input 2	Sdi 3	Input 3
		Sdi 4	Input 4	Sdi 5	Input 5		
		HDMI	Pgm				
	<b>Multiviewer</b>	<b>AutoNum</b>	<b>Off</b>	<b>Label Inf</b>	<b>Off</b>	<b>Trns Lab</b>	<b>Off</b>
		<b>MV1</b>	Preset 3	<b>MV2</b>	Preset 1	<b>L: PGM</b>	<b>R: PVW</b>

## Outputs

In general, the HS-3200 offers 6 configurable output ports (**SDI 1 – 5 / HDMI**) and all 6 ports can be configured to output one of the following:

- Flex Src 1/2
- Still 2
- Still 1
- Input 1 – 12
- CLN PVW (Clean PVW)

- CLN PGM (Clean PGM)
- PG + DSK
- PVW
- PGM
- MultiV2 (Multi view 2)
- MultiV (Multi view)

**Multiviewer**

**AutoNum:** The Multiview windows can be automatically numbered, and this option turns ON/OFF automatic numbering.

**Label Inf** turns ON/OFF Label information. Input label indicates whether the input is still (stl), live (\*), or a frozen image (frz).

**Trns Lab** turns ON/OFF the Label Transparency. Once enabled, the background of the label should turn from an opaque black to a transparent one.

**MV1/2**

The HS-3200 Multi-view monitoring is available in different multi-image layouts. These outputs can be used to monitor video and audio in a number of different configurations. For each setup, embedded audio level indication is also available on all inputs as well as the Preview and Program windows.

Preset 1				Preset 2				
Preview		Program		Preview		Program		
1	2	3	4	1	2	3	4	5
5	6	7	8	3	4	5	6	7
				8	9	10	11	12
Preset 3				Preset 4				
Preview		Program		Program		1		
1	2	3	4	5	6	2		
7	8	9	10	11	12	3	4	5
Preset 5				Preset 6				
Program		Preview		Program		Preview		
9	10	11	12	1	2	3		
Still 1	Still 2	Flex Src	Clip	4	5	6		

Preset 7				Preset 8			
Program		Preview					
7	8	9		1	2	3	4
10	11	12		5	6	7	8
				9	10	11	12
Preset 9							
Program		Preview					
1	2	3	4				
5	6	7	8				
9	10	11	12				

## R/L

On the Multiview, by default, Preview window is positioned on the left and on the right is the Program window. This option allows you to switch their positions.

## Tally Mode

Tally output port generally sends two tally signals to each channel. In Datavideo products, **Red** indicates On-Air, and **Green** indicates next video source. On the Multiview screen, the tally light is indicated by rectangular borders around the input sub windows.

### The HS-3200 provides two tally modes:

**Normal:** If in normal mode, tally lights of all video sources enabled on PGM view will be turned ON (**Red**). These sources include PGM, PIP and Key sources. While transition is in progress, tally lights of all video sources enabled on PGM view do not change color. The tally light will only change color (**Red → Green**) after transition of PGM and PVW views is complete. However, for video sources on the Preview window, the tally lights will be enabled **Green**, and the color is changed to **Red** as soon as the transition is triggered.

**Audio Mixer:** If Audio Mixer mode is selected, tally lights of all video sources enabled on PGM view will be turned ON (**Red**). While transition is in progress, tally lights of all video sources enabled on PGM view do not change color. The tally light will only change color (**Red → Green**) after transition of PGM and PVW views is complete. However, for video sources on the Preview window, the tally lights will be enabled **Green**, and the color is changed to **Red** as soon as the transition is triggered.

## GPI Out

GPI is designed to allow the user to trigger playback of an external playback device such as Datavideo's NVP-20 or HRS-30 unit. **GPI OUT** allows the user to configure your GPI connection.

First enable the GPI port and then set the GPI **mode**, which is either level or pulse. The pulse width can be configured in **Width** sub-option (1-9).

Once the GPI function is enabled, you can assign it to one of **Inputs 1-12 which can later be used to trigger external devices** and the **delay** can be set to a value between 0 and 99.

## 4.8 Audio

In the **Audio** menu, you will be able to start and shut off the embedded audio of **SDI** and **HDMI** videos.

Audio	Audio	Mode	On	Src	Input 1	
	<b>PGM Audio</b>	<b>Mode</b>	V Fade	<b>Gain</b>	0 dB	<b>Delay</b> 0 ms
	<b>Analog Out</b>	<b>Src</b>	Follow	<b>Gain</b>	0 dB	<b>Delay</b> 0 ms

### **Audio**

External audio source can only enter the HS-3200 via the analog XLR input port found on the rear panel of the main unit. Ideally the user should use the HS-3200 with an audio mixer.

It is recommended to use AM-100 or AD-200 audio mixer designed and manufactured by Datavideo. All external audio sources can be connected to AM-100 or AD-200 before entering the HS-3200. The external audio can be embedded into SDI video out.

**Mode (ON/OFF):** Setting Mode ON allows the HS-3200 to embed external audio component into SDI video out. Changing the **Mode** option from ON to OFF will mute the embedded audio.

**Audio Src:** This sub-option allows the user to select the audio source.

If “**External**” is selected, the external audio, i.e. audio from **AUDIO IN** port, will be played.

If “**Follow**” is selected, the audio will enter Audio follow Video mode, i.e. playback of the audio of the output video.

To play the audio of a particular input video channel, select an **input number** from Input 1-12.

### **PGM Audio**

#### **Mode (V Fade/X Fade)**

While working in the Audio-F-Video mode, the audio sources will also change as the video sources are switched. We can choose how the audio changes sources, whether it be a clean cut (immediate switch) or some sort of transitioned change (cross fade or fade out & in). To do this we would need to set up with the following menu options.

- **X Fade:** PGM Audio / PVW Audio cross fade
- **V Fade:** Fade out PGM Audio then fade in PVW Audio

**Gain (0 – 24 dB):** adjustment of the PGM audio volume.

**Delay (0 – 340 ms):** sets the delay of the PGM audio volume.

## Analog Out

You are also allowed to select a source of audio of your preference and output the selected audio via Audio OUT. Open the OSD menu and select Audio → Analog Out → Src where you may select a source of audio from the following list.

- PGM Audio
- Follow
- Input 1-12

If “**Follow**” is selected, the audio will enter Audio follow Video mode, i.e. playback of the PGM audio via Audio OUT **without audio output delay**. If “**PGM Audio**” is selected, the HS-3200 will only play the PGM audio via Audio OUT **with audio output delay**. You may also select to output one audio component of the 12 inputs via Audio OUT **without audio output delay**.

**Gain (-60 – 24 dB):** adjustment of the audio volume at the **AUDIO OUT**.

**Delay (0 – 340 ms):** sets the delay of the audio at the **AUDIO OUT**.

## 4.9 Files

In Files, you will be allowed to manipulate different files such as clips, still pictures, user memories and still and animated logos.

**Still** allows the user to load images from the memory, save images to the memory, and save the images captured. **User** allows you to **load** previously saved settings and **save** the currently configured settings. In **Clip**, you will be able to browse through the clip files and load the clips directly on the switcher. As for logo and ani logo menus, they allow you to load still and animated logos directly on the switcher.

All five file types will be discussed in the following sub-sections.

### User Mems

In this option, the user is allowed to **load** previously saved settings and **save** the currently configured settings.

#### Advanced mode options

Files	User			
	Load Mem	Memory	1	Load
	Save Mem	Memory	1	Save

### Load Memory

Use the up/down arrow to scroll to the desired memory location and load the saved setting by selecting “**Load**”.

**Note:** The user can also press one of the USER memory shortcut buttons (1-3) on the control panel as a quick way of loading those previously saved User configurations.

### Save Memory

Use the up/down arrow to scroll to the desired memory location and save the current setting by selecting “Save.”

### Still

**STILL image** is an image pre-loaded to the HS-3200’s input buffers (Input 1-12). The **Still** menu allows users to load still pictures from the machine’s internal memory to the input buffer, save still pictures to the machine’s internal memory, view thumbnail pictures and grab program image to the specified still memory locations.

Files	File Type	Still		
	Load Still	Load	Still Num 1	Still 1
		Thumbnail Picture – 1	Thumbnail Picture	Thumbnail Picture + 1
	Save Still	Save	Still 1	Still Num 1
				Delete
	Grab Still	Grab	Still 1	

### Load Still

Upon selecting “**Load Still**”, the user can then choose the memory location from which the still image is loaded. The system memory can store up to 500 still images. The following are the destinations to which the still image can be loaded:

- Still 1: Still 1 button
- Still 2: Still 2 button
- Input 12: Input button 12
- Input 11: Input button 11
- Input 10: Input button 10
- Input 9: Input button 9
- Input 8: Input button 8
- Input 7: Input button 7
- Input 6: Input button 6
- Input 5: Input button 5
- Input 4: Input button 4
- Input 3: Input button 3
- Input 2: Input button 2
- Input 1: Input button 1

Select “**Load**” to load the still image to the chosen destination.

**Image Preview** is available below the “**Load Still**” row. “**Thumbnail Picture – 1**” allows the user to preview the previous image, “**Thumbnail Picture**” displays the image that will be loaded when “**Load**” is selected, and “**Thumbnail Picture + 1**” shows the next image.

**Note: The user is allowed to import still picture files. It is recommended to use 24-bit without Alpha bmp, png and jpg formats.**

### **Save Still**

“**Save Still**” allows the user to save the still image to a specific memory location. The user should determine the source of the still image first. The available sources are listed below:

- Still 1: Still 1 button
- Still 2: Still 2 button
- Input 12: Input button 12
- Input 11: Input button 11
- Input 10: Input button 10
- Input 9: Input button 9
- Input 8: Input button 8
- Input 7: Input button 7
- Input 6: Input button 6
- Input 5: Input button 5
- Input 4: Input button 4
- Input 3: Input button 3
- Input 2: Input button 2
- Input 1: Input button 1

To complete the save, the user can simply select “**Save**” after determining the memory location.

To remove a still from a memory location, first scroll to the memory location, and select “**Delete**” then “**Yes**” to confirm the delete.

### **Grab Still**

“**Grab Still**” function grabs an instant of the video image on the Program view to the destinations listed as follows:

- Still 1: Still 1 button
- Still 2: Still 2 button

After determining the destination to which an instant of the video image is captured, simply select “**Grab**” to trigger the image grab.

In the following sections, we will show you how to import still images from the PC to the switcher and load the imported file to the switcher.

### **Loading still images**

The HS-3200 allows the user to load still images saved on the machine to the Multiview screen. Please follow the steps outlined below to load the still picture.

1. Press the **MENU** button to open the OSD menu on the Multiview display.
2. Open the **Stills** menu option as shown below.

<b>Files</b>	<b>File Type</b>	<b>Still</b>		
	<b>Load Still</b>	<b>Load</b>	<b>Still Num</b> 1	<b>Still 1</b>

		<b>Thumbnail Picture - 1</b>	<b>Thumbnail Picture</b>	<b>Thumbnail Picture + 1</b>
	<b>Save Still</b>	<b>Save</b>	<b>Still 1</b>	<b>Still Num 1</b>
				<b>Delete</b>
	<b>Grab Still</b>	<b>Grab</b>	<b>Still 1</b>	

3. In the **Load Still** sub-option, first select the still picture that you would like to load (**Still Num**). The still picture preview is shown in the row right below the **Load Still** row.
4. In the field next to **Still Num**, select a destination to which the still picture will be loaded. Once the destination is determined, select **Load** to load the still picture to one of the following destinations:
  - Still 1: Still 1 button
  - Still 2: Still 2 button
  - Input 12: Input button 12
  - Input 11: Input button 11
  - Input 10: Input button 10
  - Input 9: Input button 9
  - Input 8: Input button 8
  - Input 7: Input button 7
  - Input 6: Input button 6
  - Input 5: Input button 5
  - Input 4: Input button 4
  - Input 3: Input button 3
  - Input 2: Input button 2
  - Input 1: Input button 1

For more still functions such as file import from the PC or laptop, see [Section 5.3 Managing Still Pictures](#).

### **Clip**

The **CLIP** or Stinger Transition Effect is basically an animated effect added during transition of two video sources. The animated effect is generated by a clip file which consists of a series of sequential files in **bmp/jpg/png/pic** formats. In the next few sections, you will be shown how you can load the existing clip on the switcher, and import the clip to the switcher from the PC.

#### **Advanced/Basic mode**

<b>Files</b>	<b>File Type</b>	<b>Clip</b>		
	<b>Load Clip</b>	<b>Load</b>	<b>Clip 0</b>	<b>Clip Settings</b>
		<b>Thumbnail Clip - 1</b>	<b>Thumbnail Clip</b>	<b>Thumbnail Clip + 1</b>
		<b>Clear Clip</b>		<b>Delete Clip</b>



### **Load Clip**

In this sub-option, use the Up/Down arrows on the physical keyboard of the switcher to browse the clip files. Once “Load” is pressed, the selected clip will be loaded into the clip buffer and replace the previously loaded clip. **As the clip is being loaded, you will be able to view its progress on the Preview window.**

**Note: The HS-3200 comes with pre-loaded clip files. The HS-3200 also allows the user to import customized clip files. It is recommended to use 32-bit with Alpha png format.**

You can preview three clip videos at the same time. “Thumbnail Clip – 1” allows the user to preview the previous clip, “Thumbnail Clip” displays the clip that will be loaded when “Load” is selected, and “Thumbnail Clip + 1” shows the next clip. **To enable the Clip (Stinger) transition mode, simply press the CLIP button.**

To clear the loaded clip from the buffer, simply select “Clear Clip.” To remove clip from a memory location, select “Delete Clip.”

### **Clip Settings**

**Clip Settings** allow the user to set the Clip’s Start/End & Mid (Transition points) frames. After users have imported a clip, they often find that it needs some small adjustments so with these settings the user can skip unwanted frames at the start and end of the Clip. They can also choose the frame at which the fade from PGM to PVW occurs. The default is to do the fade in the middle of the clip but depending on the actual clip, the user may want to alter this position.

- **Start Frm:** Adjusts the start frame number of the Clip
- **End Frm:** Adjusts the end frame number of the Clip
- **Mid Frm:** Adjusts the PGM to PVW fade point of the Clip
- **Cancel:** Cancels any changes
- **Save:** Saves the changes for this clip as each clip is allowed to have different settings.

**Note: Clip Settings will be enabled only after the clip is loaded.**

### **Loading the existing Clip for Stinger Transition Effect**

The HS-3200 allows you to generate the stinger transition effect. To do this, the user should load the clip saved on the machine first. Follow the steps outlined below to load the clip.

1. Press the **MENU** button to open the OSD menu on the Multiview display.
2. Open the **Clip** menu option as shown below.

Files	File Type	Clip		
	Load Clip	Load	Clip 0	Clip Settings
		Thumbnail Clip - 1	Thumbnail Clip	Thumbnail Clip + 1
		Clear Clip		Delete Clip

3. In the **Load Clip** option, first select the clip that you would like to load. The **Clip Preview** is shown in the row right below the Load Clip row.

4. Select **Load** to load the clip. The load progress prompt “**Loading Clip XX/XX ...**” will appear on the Preview window. Once loaded to the clip buffer, the previously loaded clip will be replaced.

**Note: The load process can take up to tens of seconds.**

5. To enable the Clip or Stinger transition mode, simply press the **CLIP** button.

For more information about Stinger transition (importing clip files to the switcher), see [Chapter 5.4 Performing a Stinger Transition](#).

## Logo

Logo is a still image pre-loaded to the logo buffer (Logo 1/2). The **Logo** menu allows users to load logo pictures from the machine’s internal memory to the logo buffer, save logo pictures to the machine’s internal memory, view thumbnail logo pictures and adjust the logo positions.

### Advanced/Basic mode

Files	File Type	Logo		
	<b>Load Logo</b>	<b>Load</b>	<b>Logo</b>	<b>1</b>
		<b>Thumbnail Picture – 1</b>	<b>Thumbnail Picture</b>	<b>Thumbnail Picture + 1</b>
		<b>Clear Logo</b>		<b>Delete Logo</b>
	<b>Logo 1</b>	X	-37%	X 24%
	<b>Logo 2</b>	Y	0%	Y 0%

### Load Logo

Upon selecting “**Load Logo**”, the user can then choose the memory location from which the still logo image is loaded. The system memory can store up to 999 still logo images.

**Logo Preview** is available below the “**Load Logo**” row. “**Thumbnail Picture – 1**” allows the user to preview the previous logo, “**Thumbnail Picture**” displays the logo that will be loaded when “**Load**” is selected, and “**Thumbnail Picture + 1**” shows the next logo.

Select “**Load**” to load the logo to the chosen destination (Logo 1/Logo 2).

**Note: To import custom logos from your computer, see [chapter 5.5 Enabling Still Logo](#) for instructions.**

To clear the loaded logo from the buffer, simply select “**Clear Logo.**”

To remove a still logo from a memory location, first move to the memory location, and select “**Delete**” then “**Yes**” to confirm the delete.

### Positioning

The logo can be manually positioned by adjusting its XY coordinates. Note that the origin of the coordinate system is at the center of the screen.

**X:** A positive value indicates that the logo is in the right half of the screen and a negative value indicates that the logo is in the left half of the screen.

**Y:** A positive value indicates that the logo is in the top half of the screen and a negative value indicates that the logo is in the bottom half of the screen.

### **Ani Logo**

Ani Logo is an animated logo pre-loaded to the logo buffer (Logo 1/2). The **Ani Logo** menu allows users to load animated logo from the machine’s internal memory to the logo buffer, save animated logo to the machine’s internal memory, view thumbnail images and adjust logo position.

#### **Advanced/Basic mode**

<b>Files</b>	<b>File Type</b>	<b>Ani Logo</b>		
	<b>Load Ani Logo</b>	<b>Load</b>	<b>Ani Logo</b>	<b>1</b>
		<b>Thumbnail Picture – 1</b>	<b>Thumbnail Picture</b>	<b>Thumbnail Picture + 1</b>
		<b>Clear Ani Logo</b>		<b>Delete Ani Logo</b>
	<b>Logo 1</b>	<b>X</b>	<b>-37%</b>	<b>X</b> <b>24%</b>
	<b>Logo 2</b>	<b>Y</b>	<b>0%</b>	<b>Y</b> <b>0%</b>

#### **Load Ani Logo**

Upon selecting “**Load Ani Logo**”, the user can then choose the memory location from which the animated logo is loaded. The system memory can store up to 999 logo animations.

**Logo Preview** is available below the “**Load Ani Logo**” row. “**Thumbnail Logo – 1**” allows the user to preview the previous animated logo, “**Thumbnail Logo**” displays the logo animation that will be loaded when “**Load**” is selected, and “**Thumbnail Logo + 1**” shows the next animated logo.

Select “**Load**” to load the animated logo to the chosen destination (Logo 1/Logo 2).

**Note:** To import custom logo animations from your computer, see [chapter 5.6 Enabling Logo Animation](#) for instructions.

To clear the loaded logo animation from the buffer, simply select “**Clear Ani Logo.**”

To remove an animated logo from a memory location, first move to the memory location, and select “**Delete**” then “**Yes**” to confirm the delete.

#### **Positioning**

The animated logo can be manually positioned by adjusting its XY coordinates. Note that the origin of the coordinate system is at the center of the screen.

**X:** A positive value indicates that the animated logo is in the right half of the screen and a negative value indicates that the animated logo is in the left half of the screen.

**Y:** A positive value indicates that the animated logo is in the top half of the screen and a negative value indicates that the animated logo is in the bottom half of the screen.

## 4.10 Setup

In the “**Setup**” menu, the user can change the **resolution**, switch between full and simplified menu versions, reset the HS-3200 to its **Factory Default** values, adjust the **menu preferences**, enable/disable **Auto Save**, choose the preferred OSD menu **language**, **upgrade firmware** and view the **current firmware versions** (Interface, Mainboard and Keyboard).

### Advanced mode options

<b>Setup</b>	<b>Standard</b>	1080p/59.94	<b>Level</b>	Auto	<b>Save Setup</b>
	<b>Genlock</b>	Off	<b>H Phase</b>	0	<b>V Phase</b> 0
	<b>OutConv</b>	Off			
	<b>Menu Mode</b>	Advanced	<b>Brightness</b>	3	
	<b>Menu Pref</b>	Blue	<b>Transp</b>	1	<b>Position</b> Bot
	<b>Auto Save</b>	On			
	<b>Factory Def</b>	<b>Restore</b>	<b>Restr Names</b>		
	<b>Language</b>	<b>English</b>			
		<b>Network</b>	<b>Network Def</b>		
	HS-3200	s/w: v0.9.9.9	f/w: 2019-07-17	Kbd: v1.7.3	OS: v1.0

<b>Addr Mode</b>	<b>DHCP</b>			
<b>IP Addr</b>	<b>192</b>	<b>168</b>	<b>100</b>	<b>101</b>
<b>Network Mask</b>	<b>255</b>	<b>255</b>	<b>255</b>	<b>0</b>
		<b>Cancel</b>	<b>Save</b>	

### Standard

This option allows the user to choose the appropriate output resolution such as 1080i/50. Once done, simply select “Save” to confirm the selected output resolution. The available resolutions are 1080p/60/59.94/50, 1080i/60/59.94/50, and 720p/60/59.94/50.

**Note: If you’ve selected 720p for the output resolution, all inputs should have a resolution of 720p as well.**

The menu option OutConv will be activated as soon as 1080p50 or 1080p59 is selected. OutConv allows you to downgrade the resolution of the SDI video port 5 to 1080i or 720p for connecting to the HDR-70 recorder, which is a crucial device in OBV-3200 HD 12-Channel Mobile Video Studio until the HDR-90 is ready for shipment. See the section, [OutConv](#), for details of this option.

### Level

There are two different audio standards available for selection. The user can either select the EBU or SMPTE standard. By selecting AUTO allows the device to automatically detect the audio standard.

**Note:** When the image is 50 Hz, the audio follows EBU standard and when the image is 59.94/60 Hz, the audio follows SMPTE standard.

## ***Genlock***

**Genlock** is an external sync setting. **Ref IN/OUT** port receives external sync which can be either **Tri-Level** or **Black Burst** signal. **Please note that resolutions of 1080i and 720p are not appropriate for Black Burst Sync.**

Enable genlock to allow the switcher to receive external sync, then adjust its H and V phases accordingly. H phase ranges from -2190 to +2190 ms and V phase ranges between -1124 and +1124. A positive value sets sync signal leading and a negative value sets sync signal lagging.

## ***OutConv***

When the video output resolution is set to 1080p50 or 1080p59, OutConv allows you to downconvert the resolution of SDI video port 5 to 1080i or 720p for connecting to the HDR-70 recorder, which is a crucial device in OBV-3200 HD 12-Channel Mobile Video Studio until the HDR-90 is ready for shipment.

If the output resolution is 1080p50, you may downconvert the resolution to the following:

- Off
- 720p50
- 1080i50

If the output resolution is 1080p59.94, you may downconvert the resolution to the following:

- Off
- 720p59.94
- 1080i59.94

## ***Menu Mode***

The user is allowed to switch between full and simplified menu versions. Select “Advanced” for full menu display or “Basic” to display a condensed version of the OSD menu.

**Brightness:** This option allows you to adjust the keyboard brightness with 5 being the brightest and 1 being the dimmest.

## ***Menu Preference***

In menu preference, the user is allowed to set the menu color, menu transparency level, menu size and the display position.

**Menu color:** the available options are blue and grey

Options of **Menu Transparency** are listed below:

0: No Transparency

1: Background 50% Transparent (buttons not Transparent)

2: All Menu 50% Transparent

## **Menu Position**

Menu Position gives the user ability to select several positions for the Menu area on the Screen. The current options are Centre, Top, Left, Right and Bottom.

### ***Auto Save***

When enabled, your last settings will be automatically saved within 5-10 seconds after shutting down the OSD menu. Do not shut down your machine during this time. At the next boot, the machine will automatically load the last saved settings. Note that **Still Load** also triggers auto save.

Note: The **Auto Save** function does not instantly save new settings; it is only triggered 5 to 10 seconds after the OSD menu is closed. This is to avoid adverse effects on the smoothness of operation.

The **Auto Save** function does not apply to the resolution setting. To change the HS-3200's resolution, go to "**OSD Menu/Setup/Standard**" and then select "Save Setup" to save the new setting.

### ***Factory Default***

**Restore:** This option resets the machine to the factory default settings.

**Reset Names:** This resets the Multiviewer labels (Input 1-12) to their default settings.

### ***Language***

The available languages for OSD menu are English, Traditional Chinese and Simplified Chinese.

### ***Network***

The Network option allows you to view the switcher's IP address through which the computer imports image files. See [chapter 3](#) for network configuration and software installation.

**Addr Mode:** The available network connection modes are **DHCP** and **Static**. The default connection mode is **Static** with an IP address of **192.168.100.101**.

**IP Addr:** Manually enter the IP address if **Static** is chosen.

**Network Mask:** Manually enter the network mask if **Static** is chosen.

**Cancel:** Select to cancel all changes made.

**Save:** Select to save all changes made.

**Network Def:** resets network settings to factory defaults. Default settings are listed below.

- Addr: Static
- IP Addr: 192.168.100.101
- Network Mask: 255.255.255.0

### ***Software***

This option is only available when the USB storage device containing the latest firmware file is inserted. Select Upgrade to start the firmware upgrade process. See [FIRMWARE UPGRADE](#) section for more details.

At the bottom of the menu, you will be able to view the version number of the latest firmware installed.

## Chapter 5 Basic Operation

The switcher's control panel is the main control interface for the user to select video sources and take them to air during live production. On the control panel, the user will be allowed to select the transition style, enable/disable various keys, and add logos to the program view.

The OSD menu allows the user to adjust transition settings, configure chroma keys and PIP windows, assign inputs and outputs and modify audio parameters.

This section describes how you can switch video sources on the control panel using simple operations.

### 5.1 Video Switching

First let's learn the basics of video switching.

#### *Program and Preset rows*

This row of buttons is typically used to select the switcher's main Program output image. The selected source sent to the Program outputs will be **backlit Red** on this row. Simple cuts between sources can be performed on this row by pressing on the source number required for the next shot.

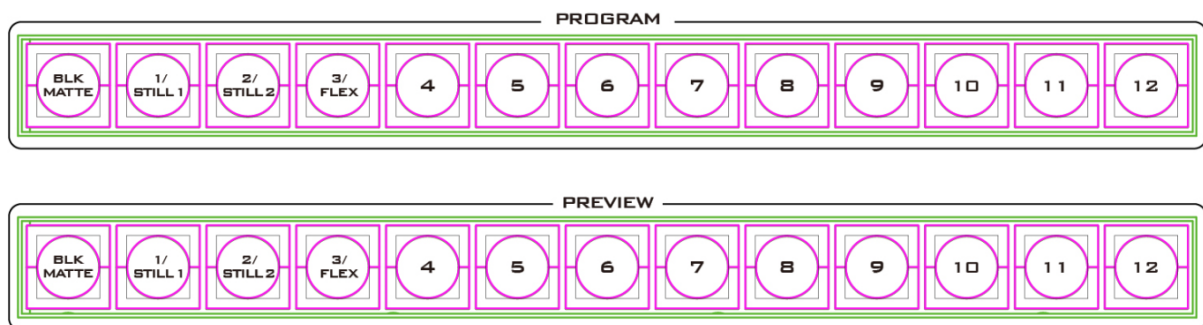

This row of buttons is typically used to select the switcher's Preview or Next source output image. The selected source will be **backlit Green** on this row. You can transition between Preview and Program using the **T-Bar**, the **CUT** button or the **AUTO** button.

**Note:** *The keys on the Program and Preview rows will still be active while the T-Bar is moving.*

#### *Black and MATTE View*



The **BLK/MATTE** button allows the user to switch between a black background, a matte colour and color bars on Program and Preview screens.

The MATTE color can be configured in the OSD menu. Simply go to 'Start' → 'Matte' and then adjust **Luma**, **Saturation** and **Hue**.

For **Hue** value, **Red** is 0, **Green** is approximately 120 and **Blue** is approximately 240. For secondary colors, **Yellow** is approximately 60, **Cyan** is approximately 180 and **Violet** is approximately 300.



The **Sat** or **Saturation value** refers to the intensity of the color selected in **Hue**. As the saturation increases, the color appears to be more pure. As the saturation decreases, the color appears to be more washed-out or pale.

The **Luma value** relates to how bright or dark the selected color or hue is. The higher the **Luma** value, the brighter the color selected in **Hue**.

### **Flex Output**

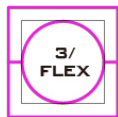

The **Flex™** output allows the user to show a variety of sources at the same time these can then be fed as one combined image to the HS-3200 Program or Preview output.

The **Flex™** output is basically a combination of one background image and four other Picture in Picture windows. Press and hold the **SHIFT** button and then press the **FLEX** button to activate the **Flex™** output. To deactivate, press the **FLEX** button again.

You will have the ability to place a user defined color border around the smaller PIP windows. You can re-size, crop, rotate and position the PIP windows in almost any manner that you wish. See [Section 4.5 Flex Src](#) for details on the Flex Output Configurations.

### **Still button**

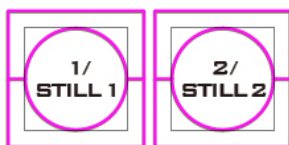

Press and hold the **SHIFT** button and then press the **STILL** button to switch the Main Program view to a still picture. Before pressing the Still button, make sure the still pictures are loaded to the still buffers (Still 1/2), which can be done in the **OSD** menu.

## **5.2 Transitions**

The **Transitions** group of buttons allows the user to decide how to bring the selected Preset / Next source image to the Program output. The HS-3200 user can decide to use a **CUT, MIX, WIPE** or **DVE (Digital Video Effect)** transition. In order to use these transition options the **TRANS BG** (Transition Background) Button needs to be enabled (backlit Red) in the **TRANS EFFECT** area of the HS-3200 Control Panel.



### **AUTO Button**



The **AUTO** button is used instead of the manually operated **T-Bar** and automatically performs the complete selected transition between Program and Preset over a set period. The **M/E** value in the **START** menu is used here. See [Section 4.1](#) on page 37 also.

### **CUT Button**



The **CUT** button is used to immediately switch between the currently selected Program and Preset sources.

### MIX Button



The **MIX** button is selected when a dissolve or fade transition between the selected Program and Preset sources is required. This **MIX** transition is produced by then moving the **T-Bar** manually or by pressing the **AUTO TRANS** button. To configure the mix transition time, open the OSD menu, then the **Start** menu, and modify the **M/E** value accordingly.

**Program View  
Before Transition**



**Transition in Progress  
(MIX Effect)**



**Program View  
After Transition**



### WIPE/DVE Button



The **WIPE/DVE** button is selected when a 2D wipe or a 3D DVE transition between the selected Program and Preset sources is required. This WIPE or DVE transition effect is produced by then moving the **T-Bar** manually or by pressing the **AUTO** button. Select 2D WIPE in **OSD menu** → **Start** → **WIPE Effects** → **WIPE**. Select 3D WIPE by pressing **DVE 1/2/3** buttons.

**Program View  
Before Transition**



**Transition in Progress  
(WIPE Effect)**



**Program View  
After Transition**



### Clip Button



Press the **Clip** button to enable the Clip (Stinger) transition mode. The Stinger Transition Effect is basically an animated effect added during transition of two video sources. The animated effect is generated by a clip file which consists of a series of sequential files in **bmp/jpg/png/pic** formats. The Stinger transition is produced by then moving the **T-Bar** manually or by pressing the **AUTO TRANS** button. See [Section 5.4](#) for instructions on loading the clip on the switcher.

### FTB Button

The **FTB** button (Fade To Black) fades the current video program source to black. When pressed again it acts in reverse from complete black to the

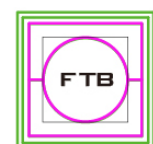

currently selected program video source. To set the transition time, open the OSD menu, then the Start menu, and modify the FTB value accordingly.

### T-Bar

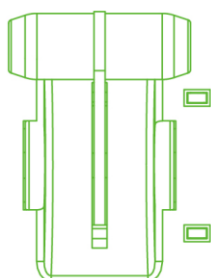

This performs a manually controlled transition from the current program source to the selected preset source. The selected transition wipe, dissolve or animation will be used. When the **T-Bar** has travelled as far as it can go, the transition between sources is complete. Please note that the **T-Bar** can be operated bi-directionally.

The **T-Bar** has indicators next to it, which light when the transition is in progress indicating the direction of operation and is off after the transition is complete.

### WIPE Selection MENU

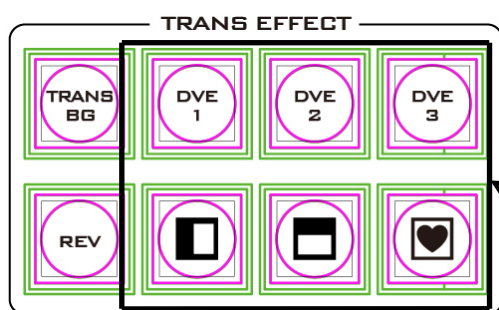

There are 32 different 2D WIPE effects and 3 different 3D WIPE effects to choose from when using the HS-3200 switcher. To select a different WIPE transition, either select a WIPE style in the **TRANS EFFECT** area of the HS-3200 Control Panel or the **Start** Item of the OSD Menu (see the table below). Before you make the selection, make sure the **TRANS BG** and **WIPE/DVE** buttons are enabled.

Start	Transition	M/E	60	DSK	15	FTB	60
	<b>Type</b>	<b>WIPE</b>					
	<b>Wipe Effects</b>	<b>Wipe</b>	1	<b>Soft</b>	0%	<b>Width</b>	1%
	<b>Border</b>	<b>Luma</b>	100%	<b>Sat</b>	80%	<b>Hue</b>	0
	<b>Position</b>	<b>X</b>	0%	<b>Y</b>	0%		
	<b>Matte</b>	<b>Luma</b>	100%	<b>Sat</b>	80%	<b>Hue</b>	0

**Note:** Open the **OSD menu** by pressing the **MENU** button in the **MENU** area of the HS-3200 Control Panel.

To select a **WIPE** on the **OSD menu**, navigate to the **WIPE** option under **WIPE EFFECTS** and then select a **WIPE number**. Each WIPE transition also has flexible user options to tailor the look of the transition. All wipes have an optional colour border applied. The wipe border **width** and **colour** are also chosen within the menu system.

### Soft Value

This value allows the 'inside' and 'outside' edge softness of the Wipe Border to be controlled. A low value makes a sharp or hard wipe edge. A large value results in a softer or diffused wipe edge.

### Width Value

This value determines how wide the actual wipe effect is. A low value makes a narrow wipe. A large value makes a wider wipe.

### Hue, Sat and Luma values

The colour of the Wipe Border Matte can also be controlled by adjusting the **Hue, Sat** and **Luma** values.

### Wipe Position

Certain Wipes, such as the **Circle** and the **Oval Wipes**, allow the Wipe position to be controlled.

The **X value** allows the selected wipe to be offset to the left or right of the screen.

The **Y value** allows the selected wipe to be offset to the top or bottom of the screen.

### REV Button



When the **REV** Button is **OFF** the selected WIPE or DVE transition will operate in its default direction only. When the **REV** Button is **ON** then the selected transition will operate in the reverse direction.

## 5.3 Managing Still Pictures

On the HS-3200 Switcher, the user will be allowed to manipulate uncompressed still pictures with Grab and Frame Store functions. In this section, you will also be guided to load the stills saved on the switcher and display them on the monitor.

Each video channel of the HS-3200 has one frame store to which a still can be loaded, and the unit has enough storage space for up to 1000 uncompressed stills.

### Grabbing & Saving a Still to Memory

The Grab & Save options of the OSD menu allow new Still Images to be created by grabbing & saving the **current Program video frame image** to two internal still buffers in the HS-3200.

1. Press the **MENU** button to open the OSD menu (shown below) on the Multiview display.

Stills	File Type	Still		
	Load Still	Load	Still Num 1	Still 1
		Thumbnail Picture - 1	Thumbnail Picture	Thumbnail Picture + 1
	Save Still	Save	Still 1	Still Num 1
				Delete
	Grab Still	Grab	Still 1	

2. The Program output is grabbed to a Still buffer (Still 1 or 2) by selecting '**Grab**'.

3. The user can look at the Multi Image Preview and decide if this Still should be saved.

- To save a Still from the currently selected Stills buffer, the user should select a Still number that has not been used yet, and select '**Save**'.
- The save process takes about 15 seconds, after which the new thumbnail picture will be shown within the Still display under the chosen still number.

### ***Loading an existing Still from Memory***

The Still Load Menu allows stills already stored in the HS-3200 to be loaded to a Still buffer (Still 1 or 2) or an Input buffer (Inputs 1 – 12). Follow the steps below to load the still.

Files	File Type	Still		
	Load Still	Load	Still Num 10	Still 1
		Thumbnail Picture – 1	Thumbnail Picture	Thumbnail Picture + 1
	Save Still	Save	Still 1	Still Num 10
				Delete
	Grab Still	Grab	Still 1	

The Still menu screen (shown above) shows thumbnail pictures of up to 3 saved stills at a time. If there are more than 3 stills stored in the HS-3200 then the Menu Control's up/down arrow buttons can be used to move through the saved stills. The stills are shown in numerical order, and any numbers not used will be blank.

To load a still, simply browse to a Still number and select a still buffer then select '**Load**'. The selected still will be loaded into the selected buffer. In the above example, the still buffer will be loaded with the image in memory slot 10.

### ***Deleting a saved Still from Memory***

To delete a saved still, select a still number that is no longer required. Select '**Delete**' and you will be prompted to confirm the delete. Select '**YES**' to remove the still from the switcher's memory and '**No**' to cancel the delete.

**Note:** The deleted still, if pre-loaded to the current Still or Input buffer, will be kept until another still image is selected or grabbed to occupy this buffer.

### ***FS – Frame Store Button***



The HS-3200 has twelve video channels and each of these channels has its own Frame Store, making a total of twelve Frame Stores. Each of these Frame Stores can hold one still image. The FS button allows the user to call the still image into the production and toggle between that still image of the Frame Store and the live video input connected to that same video channel.

#### **How to choose live video input or Frame Store**

- First press and hold down the FS button. The Preset row of input sources will flash green.

2. While still holding down the FS button, press the required input on the Preset row.  
For example, pressing button 1 switches the video channel to the still picture mode.
3. To return to the live video mode, simply press the channel button again.

This selection will also be confirmed on the Multi-view output, with the selected channel showing the live input or frame store image.

**Note:** Before using the FS function, first make sure the still picture has been loaded to the input video channel. Refer to [Section 5.3](#) for instructions on loading still pictures.

### ***Import Still Images from PC***

The Switcher Image Import/Export software (**SwitcherImageImEx\_vx.x.x.msi**) allows the user to import still pictures from the PC to a designated Still number in the switcher. **The software installation package can be downloaded from the product page.** Features of the Import/Export software are listed as follows:

- Supported file formats are BMP, JPG, PNG, and PIC.
- Minimum resolution is 1280 x 720.

See [Chapter 3](#) for installation instructions and network configuration.

#### ***How to use***

1. After the utility is successfully installed, double click the icon to run the program. Since the program is executed for the first time, it will automatically scan the network and if multiple network interface cards are found, simply select the card that is on the same network as the device.

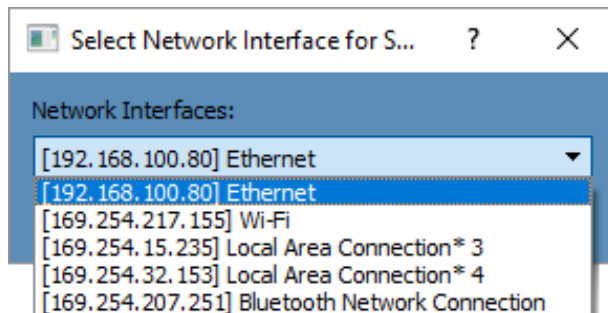

2. If the available device is scanned and found, the connection will be automatically established and the **Connect Status** will show "**Connected**" (will show **Not Connected** if disconnected).



3. After clicking the **Setup** button, you will see the network information as shown below.



4. Click the **Still** button to view thumbnails of still pictures and import still pictures from your PC.



5. Click the Still number first and enter a location for storing the still. Then click Import Still and the interface for selecting still files will appear. If the selected picture is not 1120x1080 or 1280x720, the interface shown below will pop up to allow you to crop or zoom in/out the picture.

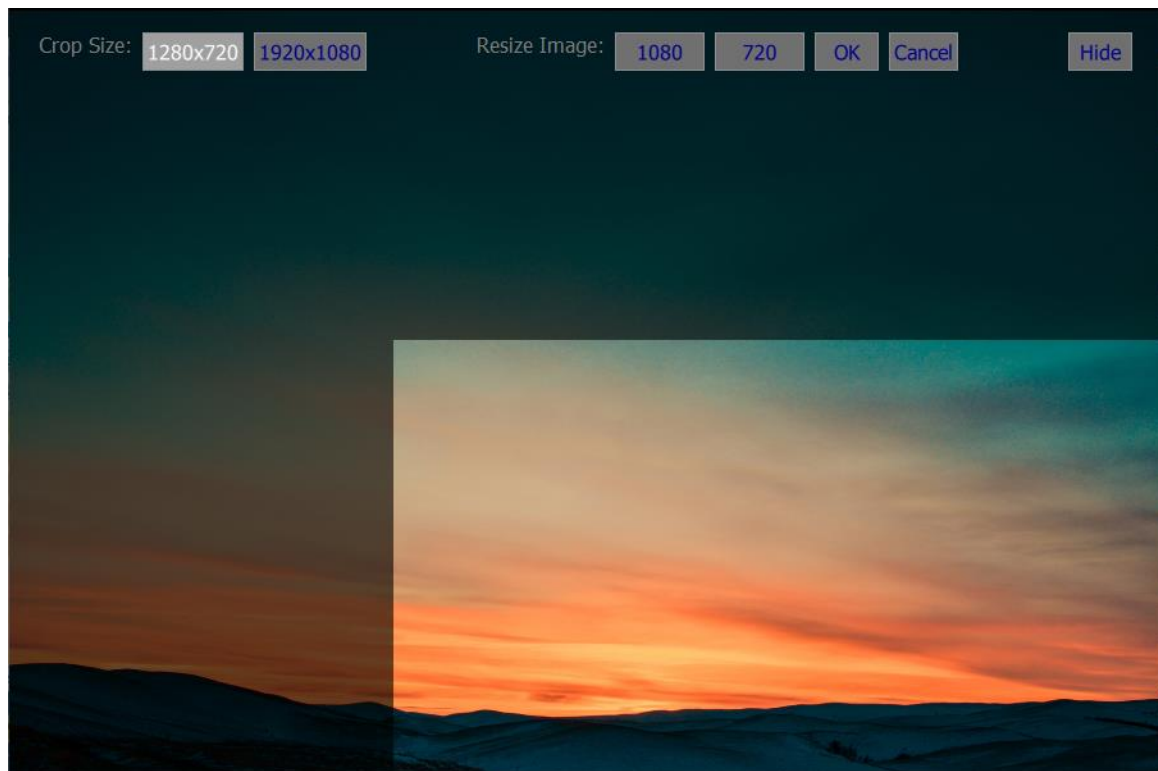

**Crop Size:** Select the right crop



**Resize Image:** You will be allowed to select two sizes, large (1080) or small (720), and zoom the picture to 1920 x 1080 or 1280 x 720.

**OK:** Apply the crop and start the import.

**Cancel:** Cancel the selection

**Hide:** Hide the interface

6. After the right crop is selected or the resolution is correctly configured, click OK to start importing the still picture to the switcher.
7. To confirm that the still picture is imported successfully, click the **Still** button on the **MENU SELECT** pane to view the thumbnails. OSD menu is another way to confirm the import, simply go to Files → File Type → Still.



## 5.4 Performing a Stinger Transition

The Stinger Transition Effect is basically an animated effect added during transition of two video sources. The animated effect is generated by a clip which consists of a series of sequential files in **bmp**, **jpg**, **png** or **pic** format. This type of transition is very popular in sports productions for transitioning in and out of instant replays.

In this section, we will explain how to build and perform stinger transitions.

### **Loading a Clip from Memory**

In **Clip**, use the Up/Down arrow buttons on the physical keyboard of the switcher to browse the clip files. Once "**Load**" is pressed, the selected clip will be loaded into the clip buffer and replace the previously loaded clip.

Files	File Type	Clip		
	Load Clip	Load	Clip 0	Clip Settings
		Thumbnail Clip - 1	Thumbnail Clip	Thumbnail Clip + 1
		Clear Clip		Delete Clip

**Note:** The HS-3200 comes with pre-loaded clip files. The HS-3200 also allows the user to import customized clip files. It is recommended to use 32-bit with Alpha png format.



Preview of clip videos is below the “Load Clip” sub-option. You can preview three clip videos at the same time.

After the clip video has been successfully imported, to enable the Clip (Stinger) transition mode, simply turn ON the Clip button.

### Importing the Clip for Stinger Transition Effect from PC

On the HS-3200, besides using the existing clips on the machine, you are also allowed to import your own clip (a series of **bmp/png/jpg/pic** files) to the HS-3200 from the PC using the **Switcher Image Import/Export utility**. Simply select one of the sequential files numbered by the last five digits of the file name and the utility program will start linking all images (from the first selected file to the last) up into a sequential animation file. The optimal resolution is 1920x1080.

Instructions for importing the clips are provided below:

Click the **Clip** button on the **MENU SELECT** pane.



The clip number allows you to select a location where you can save the clip. To import a clip from the computer into the HS-3200, select **Import Clip**.



**Tip:** The **Switcher Image Import/Export utility** does the conversion from bmp/png/jpg to the .pic file format automatically. All you need to do is to give the utility a starting file location and it will give the utility an idea where to start linking all images up into a sequential animation file.

### Importing Clips

Select “**Import Clip**” will open a file browser window. Browse to the directory where your clip files are saved and then select the file at the zeroth location, in our example on the right, the file name is **frame-000.png**.

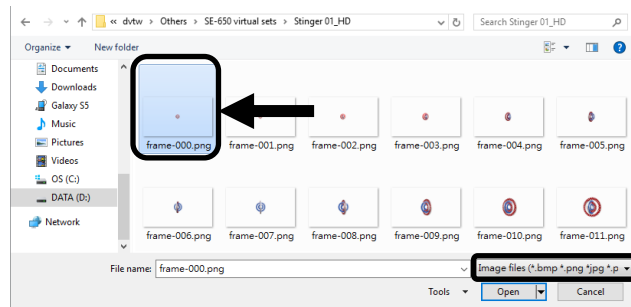

Click **Open** to start the clip import. If your files are not the .pic format, they will be automatically converted to .pic format by the **Switcher Image Import/Export utility** first.

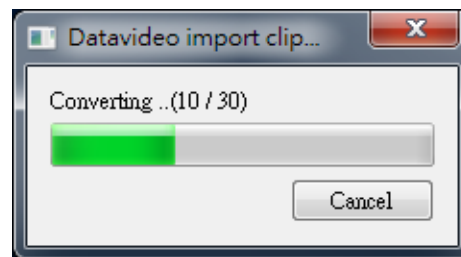

After the file conversion, the clip import will then start. After the import is complete, the progress dialog will be automatically closed.

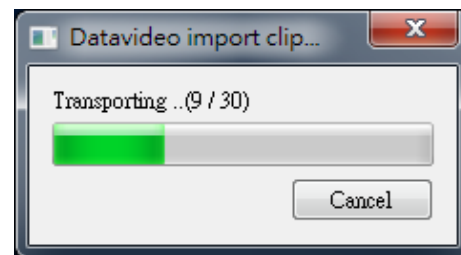

**Note:** Clip Conversion and Clip Import have progress dialogs that show progress & number of frames done. These dialogs also have a cancel button which allows the user to cancel the import at any stage. If the import is cancelled, then the partially imported data will be deleted.

### ***How to Create the PNG Sequence for Stinger Transition Effect***

Adobe After Effects is a motion graphics application that can be used for creating the clip file for stinger transition effect. After the clip file is created, there are two ways to convert the file to the PNG sequence format readable by the HS-3200 switcher in Adobe After Effects. In this section, we will show you how you can create the PNG sequence for the Stinger transition effect.

#### ***Adobe After Effects***

1. Click **File** → **Export** → **Add to Render Queue** (or alternatively, you can also click **Composition** → **Add to Render Queue**).



2. The Render Queue will be displayed in the bottom pane.

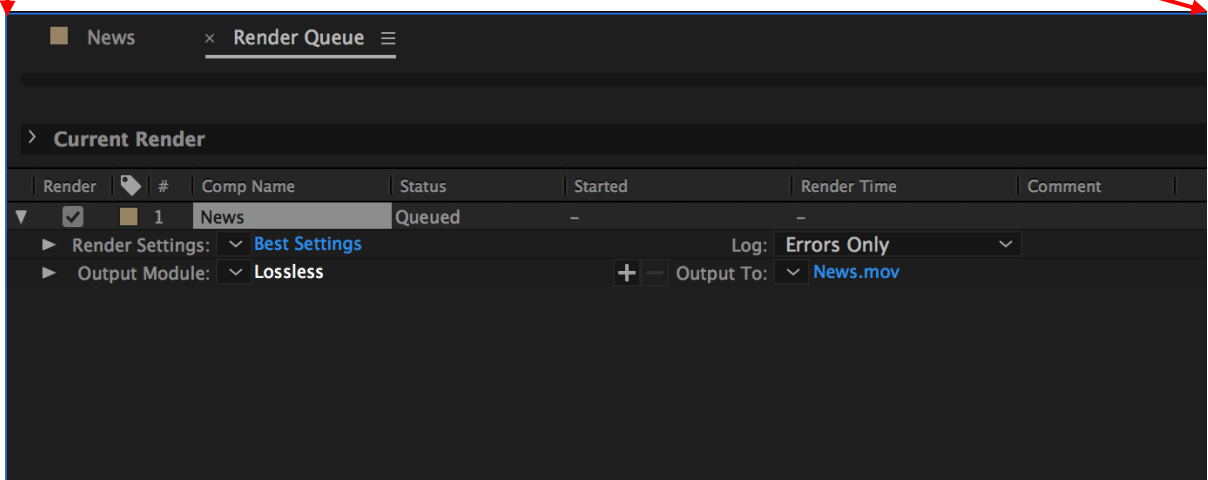
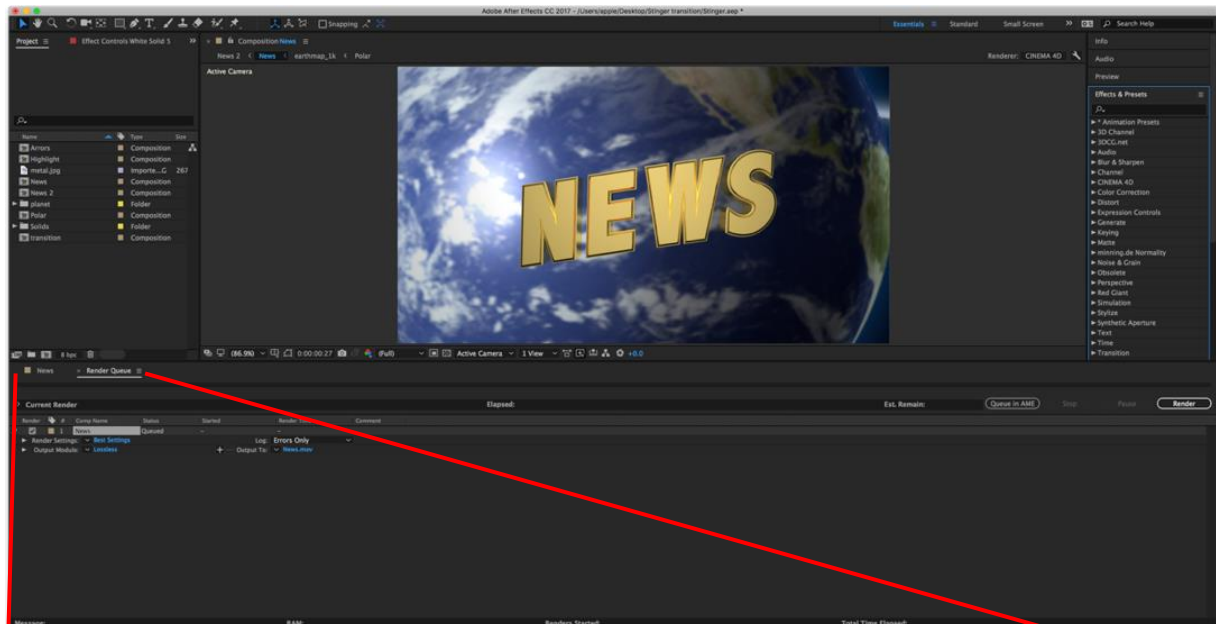

3. Click **Output Module** and on the **Main Options** window, click the **Format** dropdown list and select **PNG Sequence**.

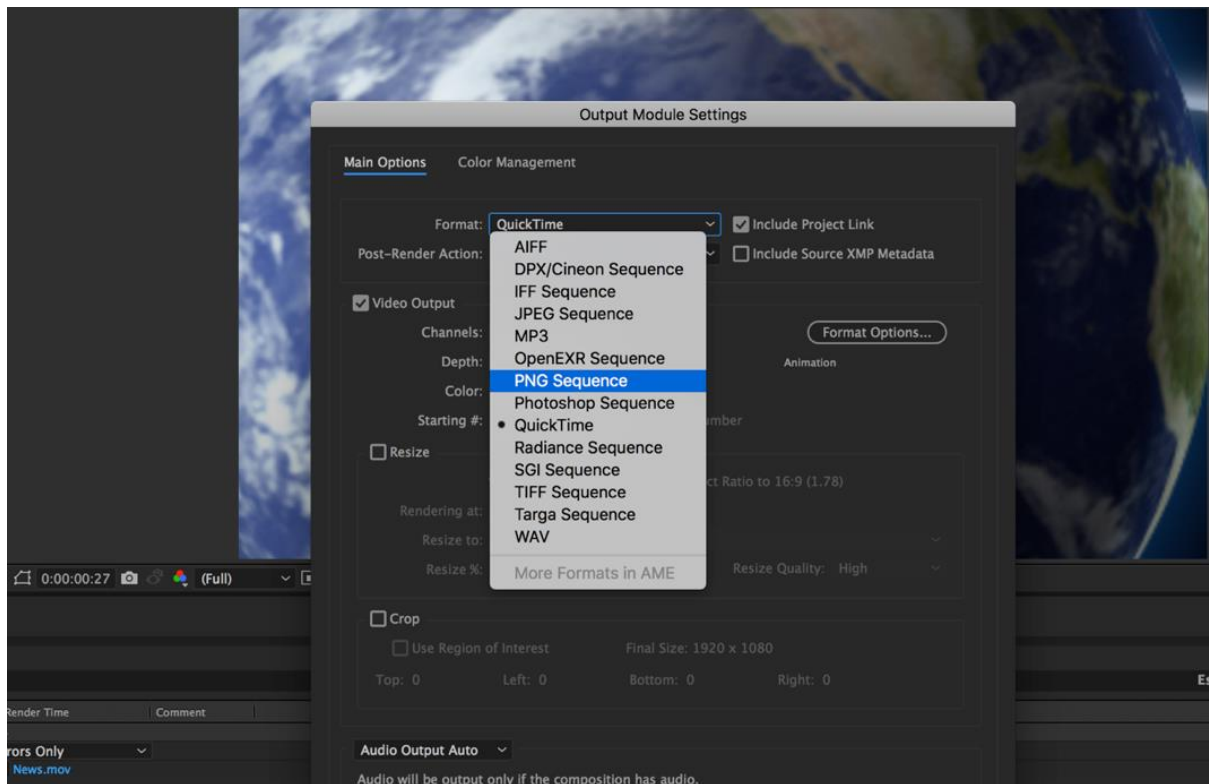

4. Click the **Channels** dropdown list and select the “**RGB + Alpha**” option.

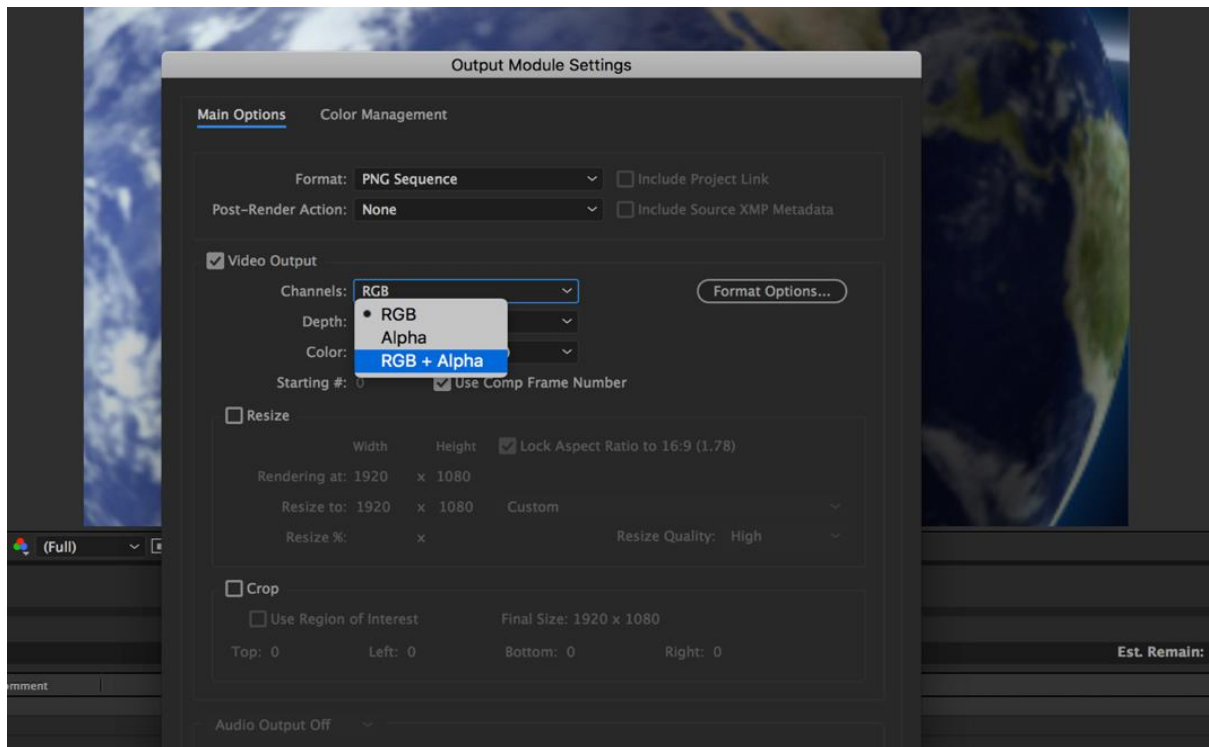

5. Click “**Output To**” and then change the location where your files are rendered. Click **Render** after that.

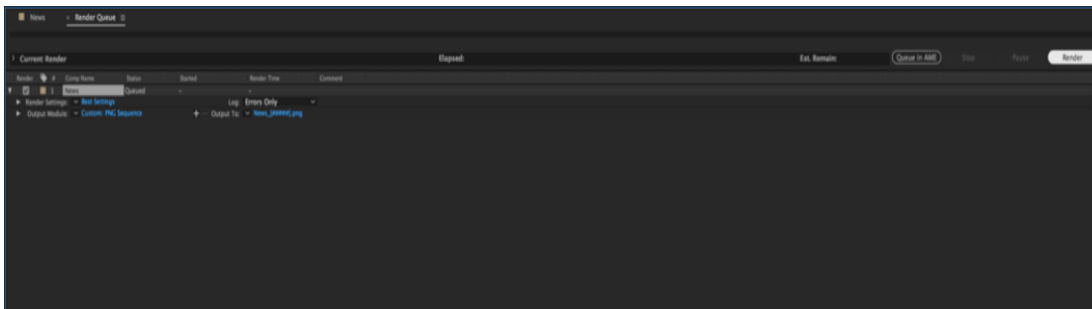

The next section outlines the file conversion procedure using the **Media Encoder CC**.

### Adobe Media Encoder CC

1. Click **Composition** → **Add to Media Encoder Queue** (or alternatively, you can also click **File** → **Export** → **Add to Media Encoder Queue**).



2. Click blue fonts in **Format/Preset** fields to open the “**Export Settings**” window.

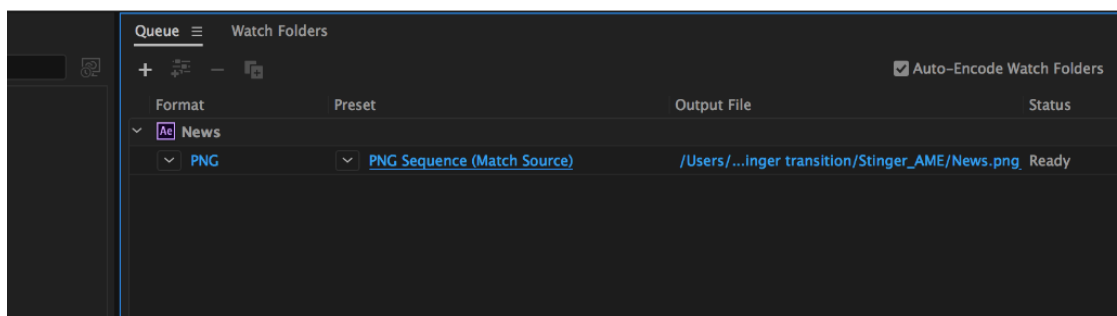

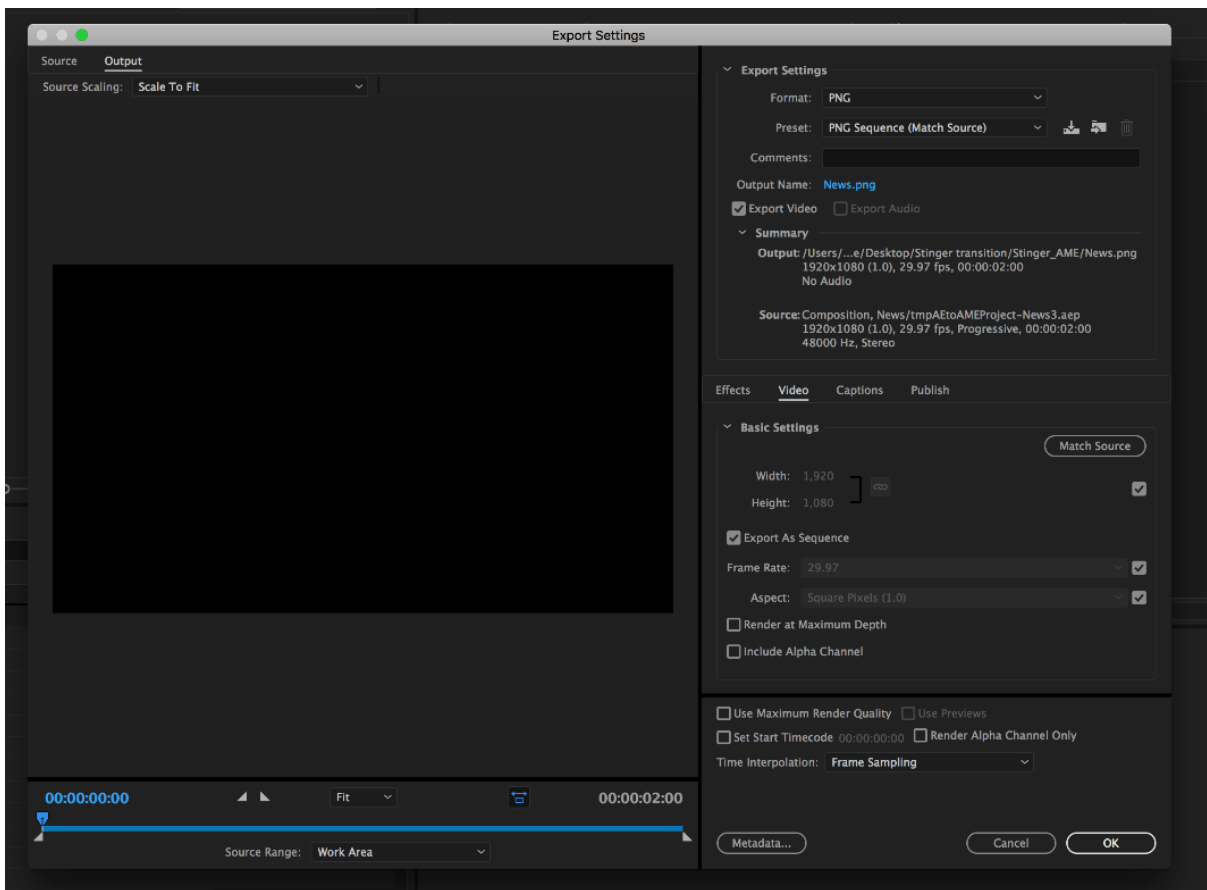

3. Click the **Format** dropdown list and then select **PNG**.

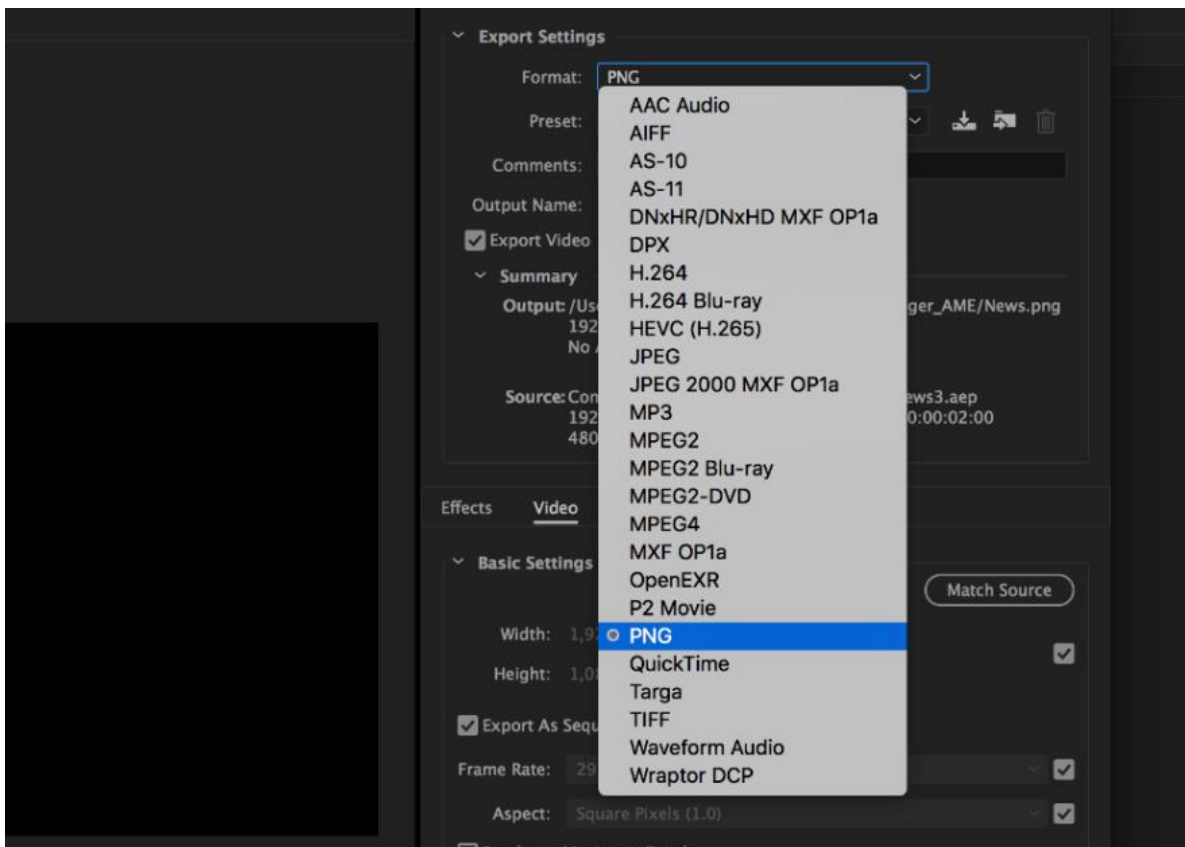

4. Click the **Preset** dropdown list and select “**PNG Sequence with Alpha.**”

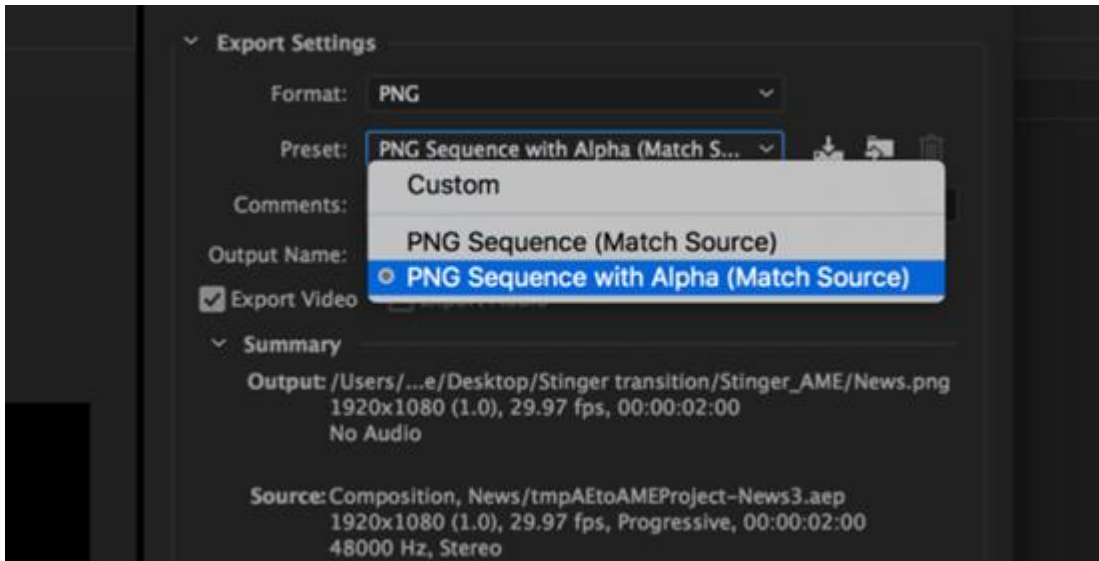

5. Make sure “**Export As Sequence**” and “**Include Alpha Channel**” are checked and then click **OK**.

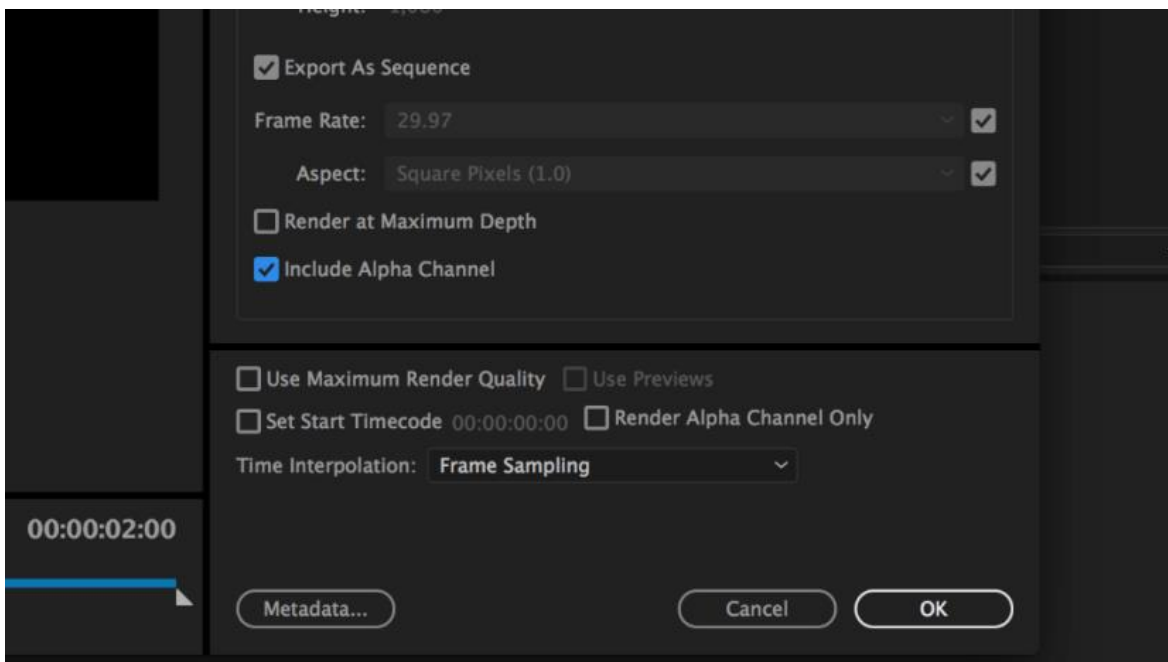

6. Select “**Output File**” to choose the render files destination. Click the green button to render.

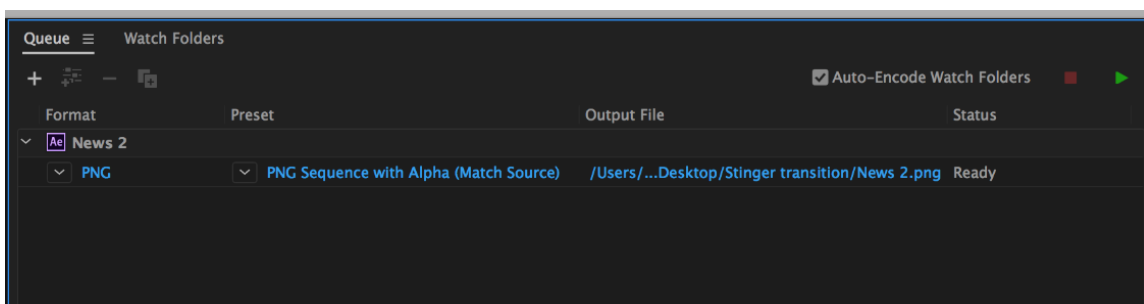



7. Once completed, the status will display “Done.”

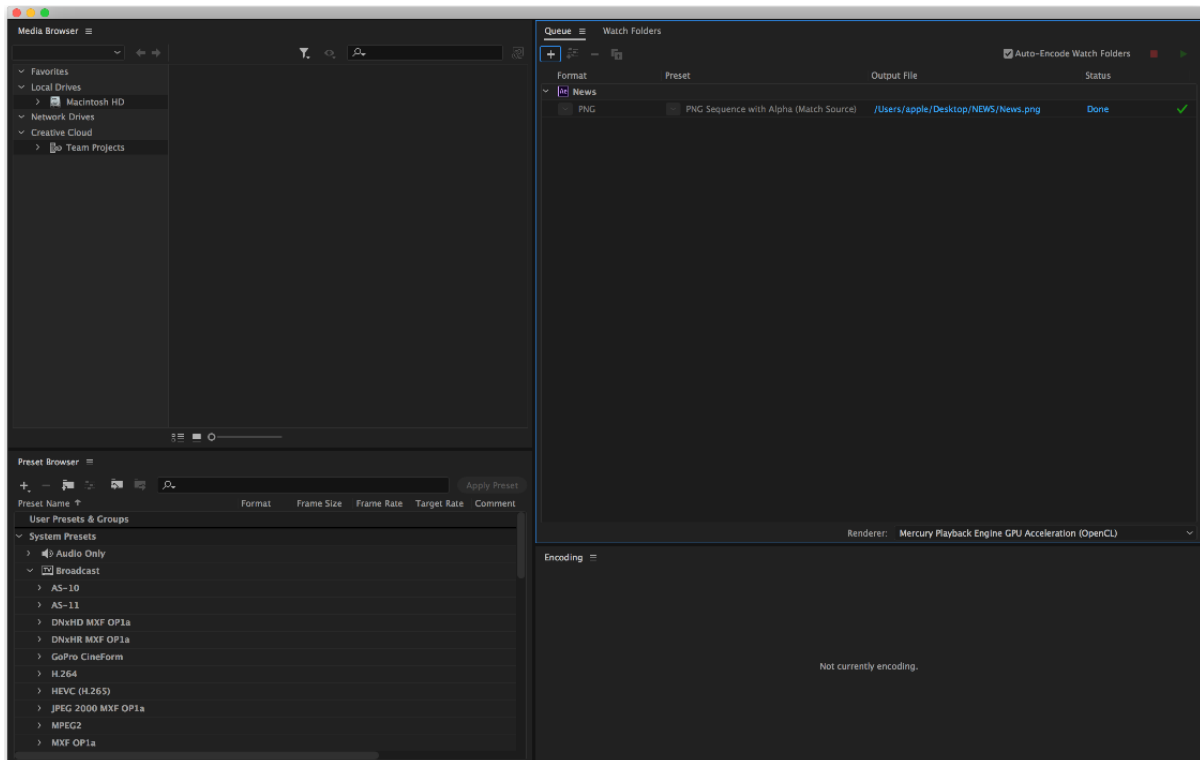

After the sequential files are created and ready, see the following sub-sections on how you can import the Clip file to the switcher.

### ***Important things to note while creating Stinger Transition Effects***

When using Datavideo’s HS-3200 Multi-Channel Switcher to design and create the Stinger Transition Effects, in addition to being creative, there are a few things that you need to take into account of.

#### **1. Length limit of the stinger transition animation**

The length of a good stinger transition animation should be approximately 0.5 to 2 seconds.

#### **2. The HS-3200 allows a maximum of 200 image files in an animation sequence**

The number of image files will determine the length of stinger transition time.

#### **3. While designing the animation, it is best to have an image that fills up the entire frame to create a satisfactory visual effect (please see the images below).**





## 5.5 Enabling Still Logo

The HS-3200's logo function places a logo layer on your video. In this section, we will show you how to import still logo image to the switcher, load still logo image on the switcher as well as enabling the loaded still logo on Preview and Program Out.

The HS-3200 has enough storage space for up to 1000 uncompressed still logo pictures.

### *Loading an existing Logo from Memory*

The HS-3200 allows the user to load still logo from the machine's memory to the logo buffer (Logo 1 or 2), then press either Logo 1 or Logo 2 button to enable the loaded logo on both the Preview and Program Out. Follow the steps outlined below to load the desired still logo from memory.

Files	File Type	Logo			
	Load Logo	Load	Logo	13	Logo 1
		Thumbnail Picture – 1	Thumbnail Picture		Thumbnail Picture + 1
		Clear Logo			Delete Logo
	Logo 1	X	-37%	X	24%
	Logo 2	Y	0%	Y	0%

On the still logo menu, you should find a thumbnail view of three logos. Use the up/down arrow buttons to browse all other logos which are shown in numerical order. Black thumbnails are unused memory slots.

To load a still logo, simply browse to a still logo number and select a logo buffer then select 'Load'. The selected still logo will be loaded into the selected buffer. In the above example, logo 1 will be loaded with the logo saved in memory slot 13.

To adjust the logo position, simply change the **X** and **Y** values of the respective logo buffer which can be found at the bottom of the **Logo** menu.

Selecting “Clear Logo” clears the logo buffer. Selection of “Delete Logo” removes the logo from the selected memory slot.

### **Importing Still Logo from PC**

The Switcher Image Import/Export software (**SwitcherImageImEx\_vx.x.x.msi**) allows the user to import still logos from the PC to a designated memory slot of the switcher. **The software installation package can be downloaded from the product page.**

**Note: A standard still logo is basically a still picture with an aspect ratio limited to 480x720.**

See [Chapter 3](#) for installation instructions and network configuration.

#### **How to use**

1. Open the Switcher Image Import/Export Program and make sure the **Connect Status** shows “**Connected**” (shows **Not Connected** if disconnected).

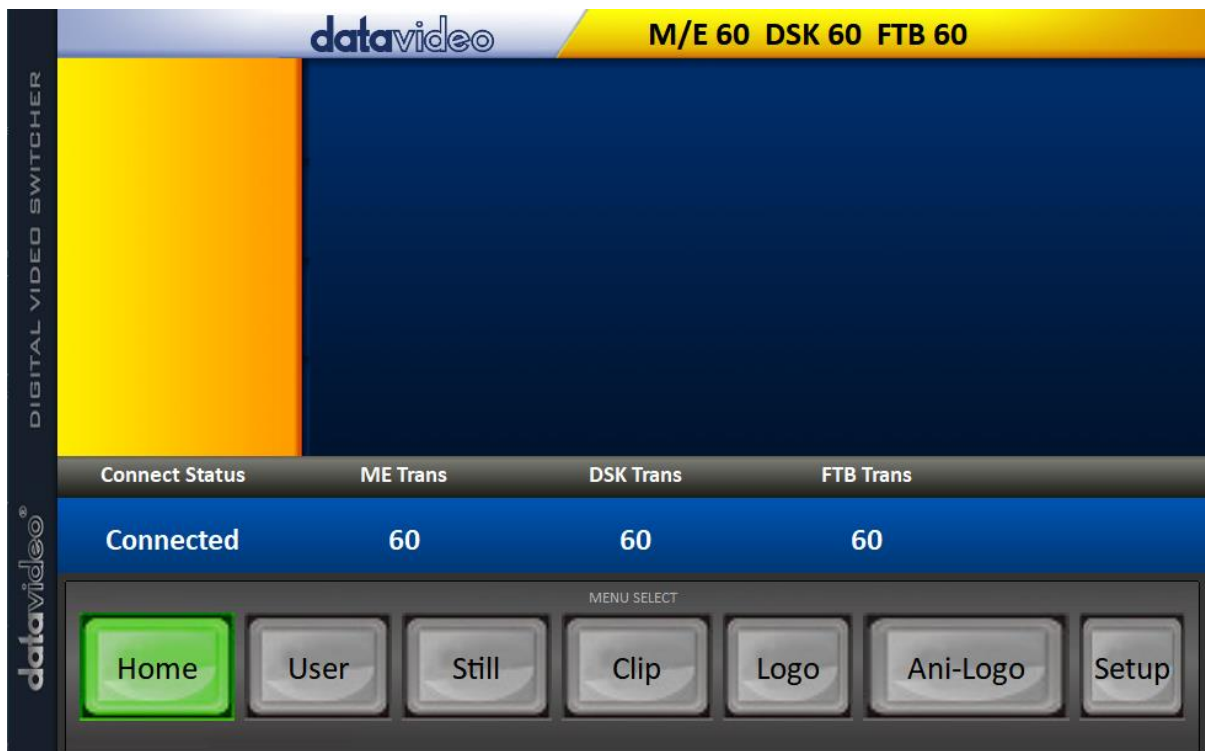

2. Clicking the **Logo** button to view logo thumbnails and import logos from your PC to the switcher.



3. Click “**Logo**” number then enter a memory slot number. Click “**Import Logo**” to open the file browser window and browse to the file that you would like to import.
4. Select the logo file that you would like to import. **Note that the aspect ratio is limited to 480x720.**
5. Check on the program’s Logo page to make sure that the logo has been imported successfully.



6. After successfully importing the logo into the switcher, you will then be able to start loading the new logo to the buffer. To enable the logo on Preview and Program Out, press the Logo button.

## 5.6 Enabling Logo Animation

The HS-3200's logo animation function places an animated logo layer on your video. Each animated logo consists of a series of 120 sequential files in bmp, jpg, png or pic format. Every image file is limited to an aspect ratio of 480x270.

In this section, we will show you how to import animated logo to the switcher, load animated logo on the switcher as well as enabling the loaded animated logo on Preview and Program Out.

**Note: The HS-3200 has enough storage space for up to 1000 uncompressed animated logo.**

### *Loading an existing Ani-Logo from Memory*

The HS-3200 allows the user to load ani logo from the machine's memory to the logo buffer (Logo 1 or 2), then press either Logo 1 or Logo 2 button to enable the loaded ani logo on both the Preview and Program Out. Follow the steps outlined below to load the desired ani logo from memory.

Files	File Type	Ani Logo		
	Load Ani Logo	Load	Ani Logo 13	Logo 1
		Thumbnail Picture – 1	Thumbnail Picture	Thumbnail Picture + 1
		Clear Ani Logo		Delete Ani Logo
	Logo 1	X -37%	X 24%	
	Logo 2	Y 0%	Y 0%	

On the ani logo menu, you should find a thumbnail view of three animated logos. Use the up/down arrow buttons to browse all other animated logos which are shown in numerical order. Black thumbnails are unused memory slots.

To load an animated logo, simply browse to an ani logo number and select a logo buffer then select '**Load**'. The selected animated logo will be loaded into the selected buffer. In the above example, logo 1 will be loaded with the animated logo saved in memory slot 13.

To adjust the animated logo position, simply change the **X** and **Y** values of the respective logo buffer which can be found at the bottom of the **Ani Logo** menu.

Selecting "**Clear Logo**" clears the logo buffer. Selection of "**Delete Logo**" removes the animated logo from the selected memory slot.

### *Importing Animated Logo from PC*

The Switcher Image Import/Export software (**SwitcherImageImEx\_vx.x.x.msi**) allows the user to import animated logos from the PC to a designated memory slot of the switcher. **The software installation package can be downloaded from the product page.**

**Note:** Each animated logo consists of a series of 120 sequential files in bmp, jpg, png or pic format. Every image file is limited to an aspect ratio of 480x270.

See [Chapter 3](#) for installation instructions and network configuration.

### How to use

1. Open the Switcher Image Import/Export Program and make sure the **Connect Status** shows “**Connected**” (shows **Not Connected** if disconnected).

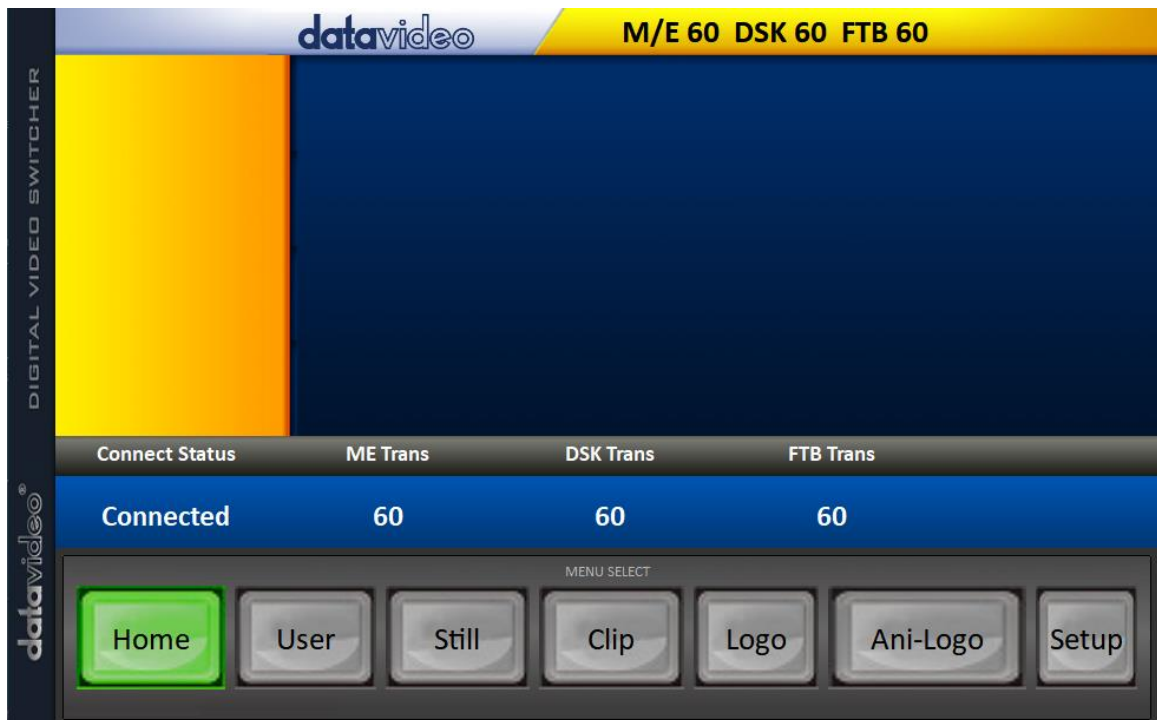

2. Clicking the **Ani-Logo** button to view animated logo thumbnails and import animated logos from your PC to the switcher.



3. Click “Ani Logo” number then enter a memory slot number. Click “Import Ani-Logo” to open the file browser window and browse to the file that you would like to import.
4. Select the animated logo file at the zeroth location so upon file import, the program will then link all images up into a sequential animation file. If your files are not the .pic format, they will be automatically converted to .pic format by the program first.
5. Check on the program’s Ani Logo page to make sure that the animated logo has been imported successfully.

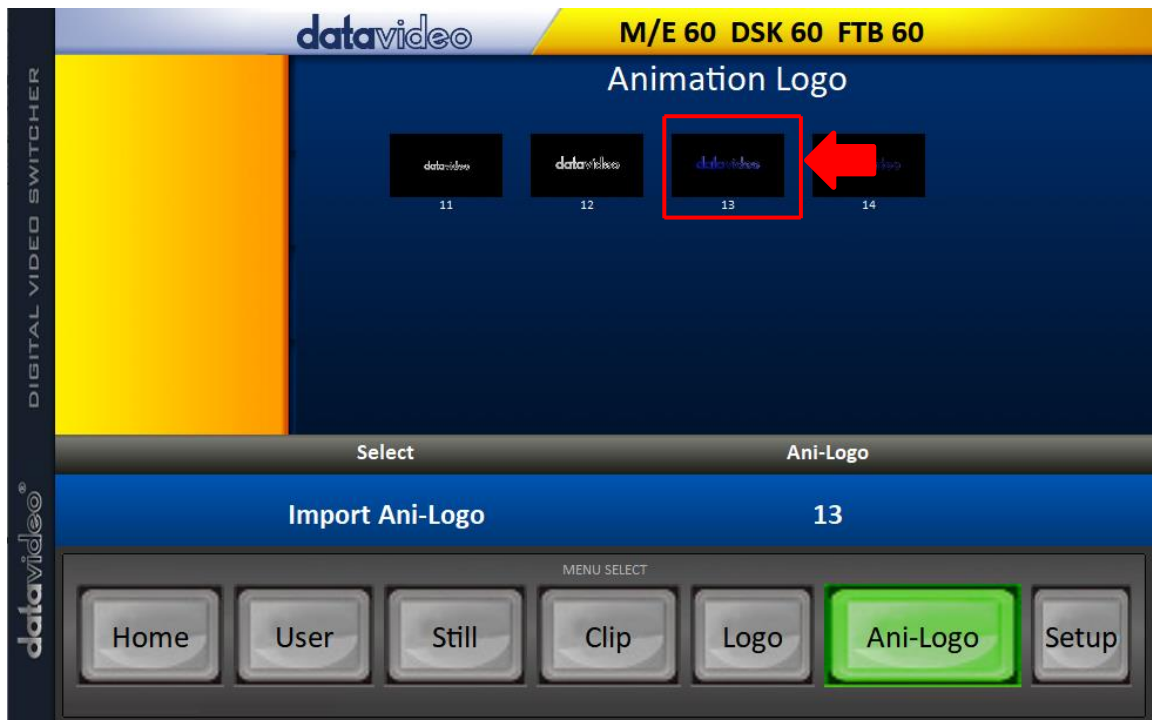

6. After successfully importing the animated logo into the switcher, you will then be able to start loading the new animated logo to the buffer. To enable the animated logo on Preview and Program Out, press the Logo button.

## Chapter 6 Advanced Operation

The HS-3200 is a High Definition Digital Video Switcher. As well as mixing video and audio sources, it has additional functions such as Picture In Picture (PIP), DSK, LUMA KEY, Chroma Key and Logos.

Before attempting to use the HS-3200's PIP, DSK LUMA KEY and LOGO functions it may help to first understand the order of the video layers at the HS-3200 Program (PGM) outputs.

### PROGRAM or PREVIEW Layers



- When logos 1 and 2 are enabled on PROGRAM and PREVIEW windows at the same time, you will be allowed to select two types of logos.
- Standard logo: max size of 480 x 1080 (1 still frame)
  - Animation logo: max size of 480 x 270 (dynamic made up of 120 frames)

The **Background video layer** is the normal video layer (**black screen, color matte, color bars, inputs 1-12, still pictures 1 and 2 or Flex™ sources**) when mixing and switching with the HS-3200. It occupies the whole screen area of the Program output. This layer can be hidden or partly hidden by the PIP, DSK and LOGO layers in front of it.

The **Key 1 layer (PIP1, chroma key or luma key)** does not occupy the whole screen and is shown in front of the Background video layer when enabled.

The **Key 2 layer (PIP2, chroma key or luma key)** does not occupy the whole screen and is shown in front of the Background video and Key 1 layers when enabled.

The **Key 3 layer (PIP3, chroma key or luma key)** does not occupy the whole screen and is shown in front of the Background video, Key 1 and Key 2 layers when enabled.

The **Key 4 layer (PIP4, chroma key or luma key)** does not occupy the whole screen and is shown in front of the Background video, Key 1, Key 2 and Key 3 layers when enabled.



In some setups the Key image can be hidden behind other key images. This is not a fault. Change the position or size of the Key image if required.

The **DSK 1 layer** can occupy the whole screen. If set up incorrectly this layer can stop the video layers behind it from being seen properly. Re-adjust your DSK 1 settings or switch off the DSK1 function on the HS-3200 to restore the video behind it.

The **DSK 2 layer** can occupy the whole screen. If set up incorrectly this layer can stop the video layers behind it from being seen properly. Re-adjust your DSK 2 settings or switch off the DSK2 function on the HS-3200 to restore the video behind it.

The logo layer is the uppermost layer. If standard logo (still) is chosen, the maximum logo size will be restricted to 480 x 1080. If animation logo (dynamic) is chosen, the logo will be confined within 480 x 270.

**Note:** Where possible prepare and position the upper video layer elements in advance of the live production starting to avoid them appearing on the program output incorrectly.

Most broadcast networks have guidelines and advice on the use of video, images, music, logos and on screen text so it is best to check beforehand when planning a production. Do not use copyright protected content until you have the relevant permissions. Information on royalty free video, images and music is widely available, speak to your local dealer or search for advice on the internet.

## 6.1 Picture-in-Picture and Downstream Key

The **Picture in Picture (PIP)** feature of the **Key 1, Key 2, Key 3 and Key 4** layers can be used for displaying a smaller secondary image in front of the background video layer. This smaller PIP image can be resized, cropped, repositioned and even keyed by the user to avoid an important part of the background video layer being covered by it.

The **Down Stream Key layers (DSK 1 & DSK 2)** are placed on top of all the previous layers. These layers are typically used with Character Generator inputs for displaying titles, graphics, lower thirds, clocks and logos. Datavideo offer several Character Generator products (additional purchase) such as TC-200, CG-250, CG-350 and CG-500. If set up incorrectly these DSK layers can also stop the video layers behind them from being displayed properly.

The HS-3200 has six dedicated keys, **Key1, Key2, Key3, Key4, DSK 1 and DSK 2**. All six keys can be active simultaneously.

### ***Picture-In-Picture***

In this example, we are supplying the HS-3200 with an HD-SDI live video signal to input 2; this is selected on the Program row. We have also assigned a STILL image to input 6. This still image, selected on the [Keyer](#) sub menu, will be displayed in the PIP window.

**Note:** See [Section 5.3](#) for assigning a STILL image to input 6.



On the HS-3200 Control Panel / Keyboard there are eight **KEYER** keys. These are labelled Program and Preview. The upper **KEYER** keys relate to activating Picture-In-Picture images on the Program outputs. The lower **KEYER** keys relate to activating Picture-In-Picture images on the Multi-view or Preview outputs. Before activating

Picture-In-Picture images on the output image, you should first set these **KEYER** keys to PIP mode.

### **Assigning a video source to a PIP window**

On the **Keyer** sub menu you can assign a selected input to the chosen PIP video layer.

1. Open the **Keyer** sub menu and in the **Keyer Ctrl** option, set **Key 1** to the desired Key (**Luma, Chroma and Linear**) and PIP mode as shown below.

Keyer	Keyer	Key 1	Normal	
	<b>Keyer Ctrl</b>	Luma	PIP	<b>Opac</b> 100%
		<b>Lift</b> 0%	<b>Gain</b> 1.0	<b>Invert</b> Off
	<b>Key Source</b>	<b>Input 1</b>	<b>Fill</b> Black	
	<b>Mask</b>	<b>Left</b> 0%	<b>Right</b> 0%	
		<b>Top</b> 0%	<b>Bot</b> 0%	

2. In the **Key Source** option, assign an input source.
3. Activate PIP window on the Preview or Program output by pressing **Key 1 PVW** or **Key 1 PGM** button so that you can adjust the PIP window while viewing the changes made.
4. Open the **P-in-P** sub menu and adjust the PIP window settings (**positions, border, shade matte and crop**). For descriptions of the parameters, refer to the section on [P-In-P](#) for more details.

P-in-P	Keyer	Key 1		Fine	Normal
	<b>Position</b>	<b>X</b> 20%	<b>Y</b> 10%	<b>Size</b>	40%
	<b>Border</b>	<b>Normal</b>			
		<b>Luma</b> 100%	<b>Sat</b> 80%	<b>Hue</b>	0
		<b>Width</b> 2%	<b>Soft</b> 0%	<b>Opac</b>	100%
	<b>Shade Matte</b>	<b>Luma</b> 100%	<b>Sat</b> 80%	<b>Hue</b>	60
		<b>Shade Soft</b> 2%	<b>Shade Pos</b> 50	<b>Direction</b>	35
	<b>Crop</b>	<b>Left</b> 0%	<b>Right</b> 0%	<b>Size</b>	0%
		<b>Top</b> 0%	<b>Bot</b> 0%	<b>Soft</b>	0%

### Assigning a video source to a PIP window using shortcut keys

In addition to assigning a video source to a PIP window on the **OSD MENU**, the user can also use shortcut keys to easily switch between different PIP image sources. Press and hold **KEY 1-4 PGM** buttons, and the program and preview rows will start flashing. Press the program row buttons to switch the PIP image source.

### Character Generator

The built-in TC-200 Title Creator allows you to linear key the CG text or graphics over the live video. **However, please note that the following hardware restrictions apply when using this feature.**

- The built-in title overlay system (**TC-200**) works better with ATI and Intel VGA graphics cards.
- Compatibility issue such as color difference may occur when used with NVIDIA graphics cards.

Simply connect the laptop, with CG software installed, to one of the HDMI inputs (inputs 9 to 12) of the switcher. Ensure that your input image or video resolution matches the switcher’s resolution set in [OSD menu](#) → [Setup](#) → [Standard](#).

#### Then follow the steps below to set up the built-in TC-200

1. Connect the laptop to one of the HDMI ports of the HS-3200 switcher using an HDMI cable. In this example, we will be using HDMI port 9 for illustration purpose.
2. Open CG-250 on the laptop and create a CG image that can then be sent to the HS-3200 via the built-in TC-200.
3. Switch ON the HS-3200’s power button and after the boot up is complete, the Multiview should be displayed on the connected monitor.
4. On the Multiview, Input 9 window should display the CG image.
5. Press the “**MENU**” button on the HS-3200’s control panel to open the OSD menu on the Multiview display and then select the “**Inputs**” sub menu.
6. Select “**Input 9**” from the **Input** option and enable TC-200 mode by turning on TC-200 Md.

Inputs	Input	Input 9	Mode	Live	Mode	TC-200 Md
	Proc Amp	Black 0%	White 100%		Chrom	1.0
	Audio	Gain 0 dB	Delay 0 ms			
	Crosspoint	Input 9				
	Audio XPT	Off				

7. Move to the “**Keyer**” sub menu.

8. Select “**DSK 1 or 2**” from the **Keyer** option and set Key and Fill Sources to Input 9.

<b>Keyer</b>	<b>Keyer</b>	<b>DSK1</b>	Normal	
	<b>Keyer Ctrl</b>	Linear	Split	<b>Opac</b> 100%
		Lift 0%	Gain 1.0	<b>Invert</b> Off
	<b>Key Source</b>	<b>Input 9</b>	<b>Fill Input 9</b>	
	<b>Mask</b>	Left 0%	Right 0%	
		Top 0%	Bot 0%	

9. Locate DSK buttons on the switcher’s control panel then depending on the settings selected at Step 8, press DSK 1 or 2 button to open your CG graphics on either of the preview and program windows or both.

### DSK Preview and DSK Program



On the HS-3200 Control Panel / Keyboard there are four DSK keys. These are labelled Program and Preview. The upper DSK1 and DSK2 keys relate to activating Down Stream Keying on the Program outputs. The lower DSK1 and DSK2 keys relate to activating Down Stream Keying on the Multi-view or Preview outputs.

To display the CG subtitle configured previously, simply press the DSK 1 PGM or DSK 1 PVW button to enable the downstream key on the PGM or PVW screen.

## 6.2 Placing text on the video using luma key



The HS-3200 allows the user to place a logo or text image (ideally black and white) on the video using the luma key function. First of all, create a 1920x1080 (16:9) text image against a black or white background on a laptop. Once the text image is created, please follow the steps outlined as follows to insert the text image.

**Note: If the text image is dark, choose a white background; if the text image consists primarily of bright colors, choose a black background.**

1. Connect the laptop to the switcher’s **HDMI Input Port 9**.
2. Press the **MENU** button to open the OSD Menu on the Multiview display.
3. Select **Keyer** to open the **Keyer** sub menu.

<b>Keyer</b>	<b>Keyer</b>	<b>Key 1</b>	Normal	
	<b>Keyer Ctrl</b>	Luma	Self	<b>Opac</b> 100%

	<b>Lift</b>	0%	<b>Gain</b>	1.0	<b>Invert</b>	Off
<b>Key Source</b>	<b>Input 9</b>		<b>Fill</b>	Black		
<b>Mask</b>	<b>Left</b>	0%	<b>Right</b>	0%		
	<b>Top</b>	0%	<b>Bot</b>	0%		

4. Select Key 1.
5. In the **Keyer Ctrl** option, select “**Luma**” and “**Self**” to apply luma keying effect to the connected input. The luma key removes the background, in this case, the black component of the image.
6. In this example, the text image is against a black background so **reduce the Lift value to remove the black background**. Descriptions of the corresponding parameters are described below:
  - **Lift** (0 – 100%) adjusts the dark/black areas of the key image. **Reducing the value of Lift** will make dark areas of the key image more transparent. The background image will be showing only through the transparent areas.
  - **Gain** (0.0 – 16.0) adjusts the light/white areas of the key image. **Increasing the value of Gain** will make light areas of the key image more solid. The background image will be showing only through the transparent areas.
  - **Opac** (0 – 100%) adjusts the transparency of the overall foreground image, which is the text in this example. **Increasing the value of Opacity** will make the overall key image less transparent.
  - **Invert** (On/Off) sets the luma key color; luma key color is **white** if turned ON and **black** if turned OFF.
7. Set the “**Lift**” to 100% if the background is in total black.
8. **Opaque** logo can be created by setting the “**Opac**” parameter to 100%. Set “**Opac**” to 100% if an opaque logo is desired. **Semi-transparency** effect can be generated by setting the “**Opac**” parameter to a value between 0 and 100%.
9. Under the **Source** option, select an input source to which the luma key settings will be applied. In this example, select “**Input 9**” since this is the port to which the laptop is connected.

**Note: Since “Self” is chosen, Fill input will be ignored.**
10. Exit the menu after the luma key settings are properly configured.
11. Press the **Key 1 PGM** or **Key 1 PVW** button to place the text image on the Program screen or the Preview screen respectively.

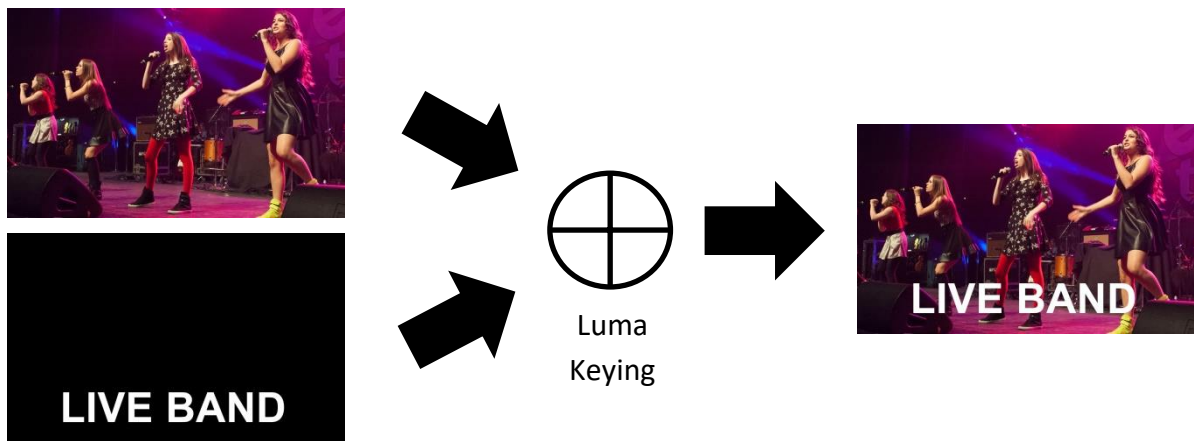

### 6.3 Insertion of People onto Backgrounds (Chroma Key)

The Chroma Key feature of the HS-3200 is easy to use. Typical Blue and Green screen studios can be quickly incorporated into an HS-3200 production.

The following is a quick overview of Chroma Key basics.

The **camera**, **backdrop** and **lighting** all play an important role in producing the optimal Chroma Key result. Although the HS-3200 is equipped with excellent keying controls, it is best to start with a good keyable image.



#### A good foreground image helps produce a good key

##### Three chip/Three sensor camera

We strongly recommend the use of a three chip or three sensor camera for Chroma Key shooting. If the camera has three chips or sensors then this usually means good colour separation within the camera. The optics on these cameras are usually better too. The extra image clarity and the good colour separation help improve the quality of the subsequent keying with the camera's output.

##### White Balance the Camera

White Balance is extremely important after setting up a chroma key studio. The camera must be correctly white balanced to minimize the subject picking up any colour cast (green or blue) from the background. Of course the white balance settings will vary according to the type of lighting you are using, but neutral whites and good skin tone colour are the all-important targets.

To set the white balance you will need a white reference card (or a sheet of white paper). Focus the camera on the reference card and light it evenly using the main light. Set the camera's iris / aperture so that the card is correctly exposed. Use the Auto White Balance (AWB) function, or set the white balance manually so that the card appears white. If you are

in any doubt about how to white balance your camera, **please refer to your Camera’s instruction manual for more details.**

## Lighting

Lighting of your chosen green or blue backdrop is extremely important; the more even the lighting on the backdrop the better the finished result. Lighting setups for the foreground subject will vary according to the effect that you want. For chroma keying backdrops, balanced even lighting with no hotspots or shadow areas is the aim. The easiest way to achieve balanced Chroma key lighting is with a lighting setup that looks similar to this:

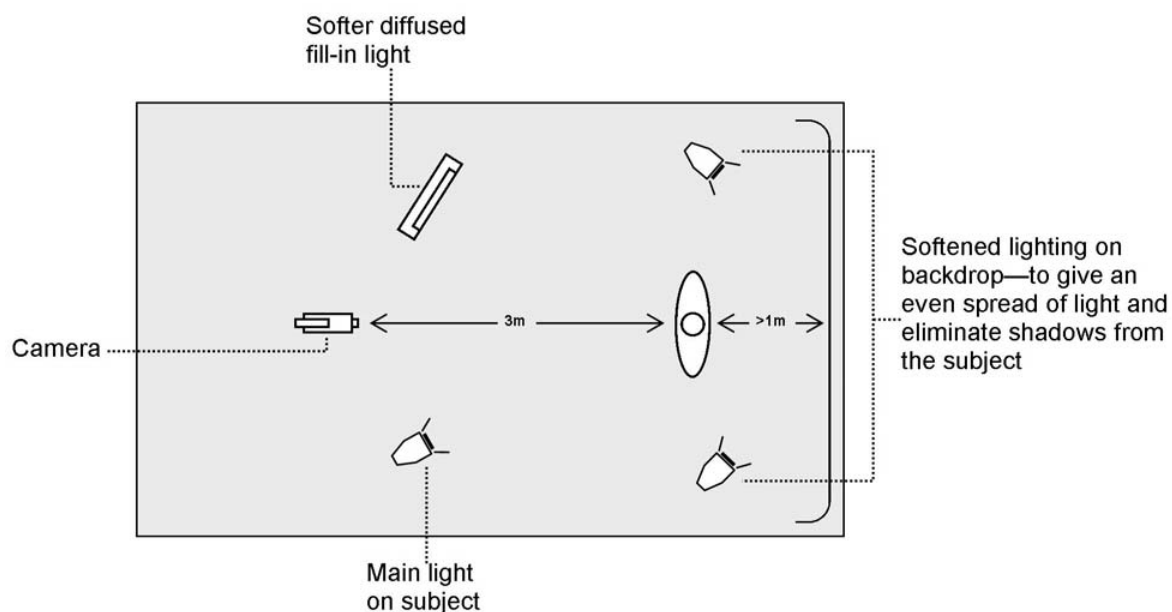

In the diagram, you will see that we recommend a **minimum** of four lights and we keep the subject **more than** 1m away from the backdrop. It is always easier to get more even lighting if the subject is farther away from the backdrop (no shadows). The foreground lighting on the subject will also vary according to the effect that you are looking for.

After the studio set up is complete, connect the camera shooting the speaker on a green backdrop to the SDI Input 1 at the rear of the switcher. To configure the settings that will be used for chroma keying, press the **MENU** button on your HS-3200 control panel to open the OSD menu on the monitor. Follow the steps below to configure the chroma key settings.

1. Open the Keyer sub menu and select Key 1.

Keyer	Keyer	Key 1	Normal	
	Keyer Ctrl	Chroma	Self	Opac 100%
		Lift 0%	Gain 1.0	Invert Off
	Key Source	Input 1	Fill Black	
	Mask	Left 0%	Right 0%	
		Top 0%	Bot 0%	

2. Select “**Chroma**” and “**Self**” under “**Keyer Ctrl**” and then select the camera source under “**Key Source.**” In this example, we have selected Input 1, which corresponds to the SDI Input 1 at the rear of the switcher and therefore the port to which the camera is connected.

3. Adjust the left, right, top and bottom values of “**Mask**” to set the chroma key range according to green or blue backdrop size.

4. Open Chroma Sub Menu and adjust the corresponding chroma key parameters. Again in this example, we have selected Input 1, which corresponds to the SDI Input 1 at the rear of the switcher.

**Note:** Selection of **CK Auto** automatically calculates the best Hue & Luma values for the current Keyer source.

Chroma	Keyer	Key 1	Normal	
	Key Source	Input 1		
	Key Tie	On	Input 6	
	CK Setup	CK Auto	Hue 110	Luma 80%
		K Range 160	K Fgnd 10%	K Bgnd 20%
		Hi-Light 0%	Lo-Light 0%	Bg-Supp OFF
		Left 0%	Right 0%	Soft 0%
	Mask	Left 0%	Right 0%	
		Top 0%	Bot 0%	

The chromakeying parameters are described below:

- **Hue:** This parameter adjusts the color of the chroma key. A typical green screen value will be around 120. Blue screen value will be around 240.
- **Luma:** The **Luma** value relates to how bright or dark the selected key colour or hue is.
- **K Range (Key Range):** **Key Range** sets the range of hues or colors (0 – 360 degrees) that closely match the background color to be keyed. The user can start with a value of 120 degrees and this value can be fine-tuned up or down depending on the setup of the green or blue screen studio.
- **K Fgnd (Key Foreground):** **Key Foreground** adjusts the performance of the chroma key in light or white areas. Apply more **Key Foreground** if the light areas are becoming too transparent.
- **K Bgnd (Key Background):** **Key Background** adjusts the performance of the chroma key in dark or black areas. Apply more **Key Background** if the dark areas are becoming too transparent.
- **Hi-Light:** Hi-light boosts the foreground key in high luminance area.
- **Lo-Light:** Lo-light boosts the foreground key in low luminance area.
- **Bg-Supp:** Turn ON **Background Suppress** removes the Luma (Brightness) of the background from the final image. If the Chroma Key Output is showing Light Edges, then the **Bgnd suppress** can be used to suppress any background Luma that is showing through on these edges.



5. After Chroma Key configuration is complete, close the OSD menu and simply press **KEY 1 PGM** or **KEY 1 PVW** button on the switcher's control panel to place the speaker on **PGM** or **PVW** Screen as shown in the diagram below.

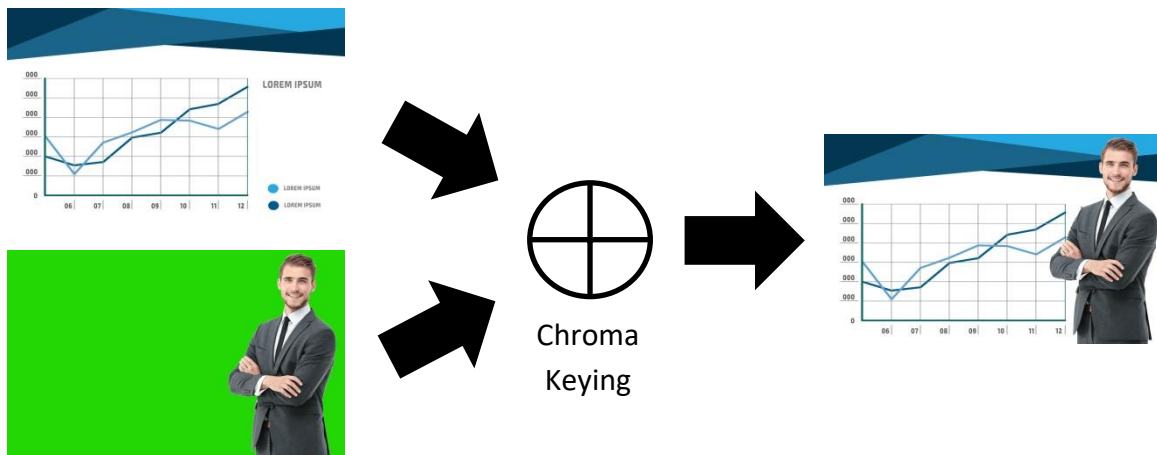

## 6.4 Displaying a variety of Sources at the same time

The Flex™ output allows the user to show a variety of sources at the same time and these sources can then be fed as one combined image to the HS-3200 Program or Preview outputs.

The Flex™ output could be as simple as one background image and four smaller source images to make a basic Flex™ layout.

Alternatively it could be a lot more complex with a fifth image source making a fifth PIP window. You also have the ability to place a user defined color border around all PIP windows. You can re-size, crop, rotate and position the PIP windows in almost any manner that you wish. With the HS-3200, you will be allowed to enable up to eight PIP windows on the Flex™ output.

To configure the Flex™ settings, simply follow the steps outline below.

### **Basic Flex™ Output (Four PIP Windows)**

1. Enable **Flex™** output on PGM or PVW window (press **SHIFT** and while holding down the **SHIFT** button, press the **FLEX** button). This will display the **Flex™** output layout on either the PVW or PGM screen so that you will be able to configure the **Flex™** output windows while viewing the changes.

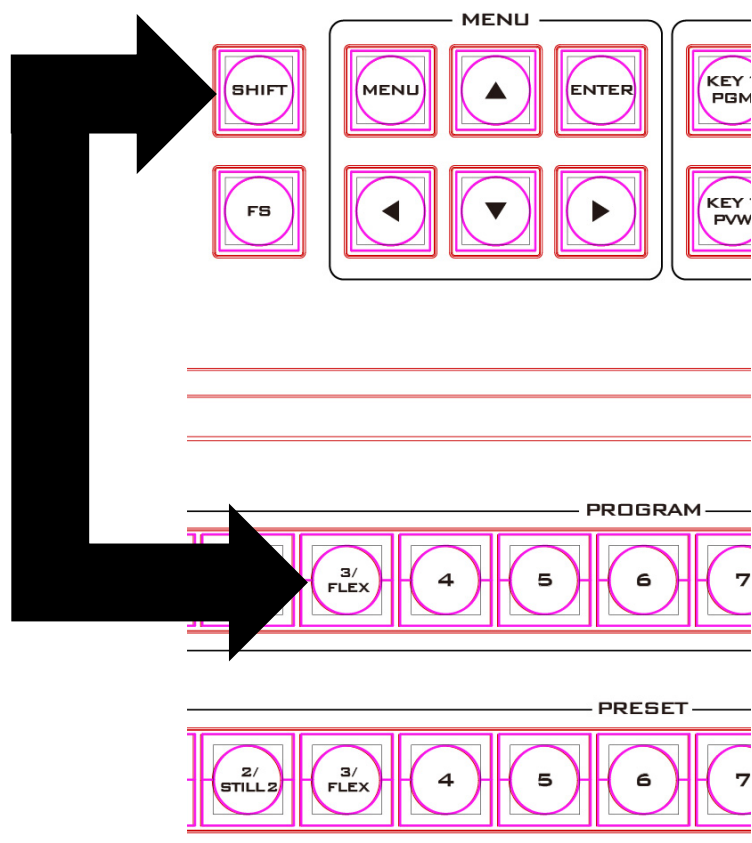

2. Press the **MENU** button on the switcher’s control panel to open the OSD menu on the Multiview screen and select **Flex Src** sub menu. On the sub menu that opens, select any of the presets to enable the desired preconfigured layout on the screen.

Flex Src	Flex Src	Flex Src 1		
	<b>Flex Src Bgnd</b>	Black		
	<b>P-in-P 1 Src</b>	Black	<b>Enable</b>	On
	<b>P-in-P 2 Src</b>	Black	<b>Enable</b>	On
	<b>P-in-P 3 Src</b>	Black	<b>Enable</b>	On
	<b>P-in-P 4 Src</b>	Black	<b>Enable</b>	On
	<b>Keyer 1</b>	Input 1	Input 2	<b>Enable</b> On
	<b>Flex Preset</b>	<b>Preset 1</b>	<b>Preset 2</b>	<b>Preset 3</b>
		<b>Preset 4</b>	<b>Preset 5</b>	<b>Preset 6</b>

3. The **Flex™** output consists of one background image and four smaller source images overlapped on the background image in four separate individual PIP windows. The options above the **Keyer** row allow you to select a source for the background (**FLEX Src Bgnd**) and then assign an input source to the respective **Flex™** output windows (**P-in-P 1 Src** to **P-in-P 4 Src**).

Flex Src	Flex Src	Flex Src 1		
	<b>Flex Src Bgnd</b>	Input 4		
	<b>P-in-P 1 Src</b>	Input 6	<b>Enable</b>	On
	<b>P-in-P 2 Src</b>	Input 7	<b>Enable</b>	On
	<b>P-in-P 3 Src</b>	Input 11	<b>Enable</b>	On

	<b>P-in-P 4 Src</b>	Input 12	<b>Enable</b>	On	
	<b>Keyer 1</b>	Input 1	Input 2	<b>Enable</b>	On
	<b>Flex Preset</b>	<b>Preset 1</b>	<b>Preset 2</b>	<b>Preset 3</b>	
		<b>Preset 4</b>	<b>Preset 5</b>	<b>Preset 6</b>	

4. In order to configure the corresponding FLEX window's size, position, border style, border color, border width and the crop settings, open the P-in-P sub menu and in the **Keyer** option, you will be able to find options **Flex PinP 1 to 4**. Select one of them and adjust the **Flex™ P-in-P** windows accordingly.

<b>P-in-P</b>	<b>Keyer</b>	<b>Flex PinP 1</b>		<b>Fine</b>		<b>Normal</b>
	<b>Position</b>	X	20%	Y	10%	<b>Size</b> 40%
	<b>Border</b>	<b>Normal</b>				
		<b>Luma</b>	100%	<b>Sat</b>	80%	<b>Hue</b> 0
		<b>Width</b>	2%	<b>Soft</b>	0%	<b>Opac</b> 100%
	<b>Shade Matte</b>	<b>Luma</b>	100%	<b>Sat</b>	80%	<b>Hue</b> 60
		<b>Shade Soft</b>	2%	<b>Shade Pos</b>	50	<b>Direction</b> 35
	<b>Crop</b>	<b>Left</b>	0%	<b>Right</b>	0%	<b>Size</b> 0%
		<b>Top</b>	0%	<b>Bot</b>	0%	<b>Soft</b> 0%

5. Once configured, save the **Flex™** settings in User Memories for easy access.

After the **Flex™** settings are successfully configured, as depicted in the diagram below, each FLEX window will display the respective source images. Use the **Flex™** feature in different scenarios and apply the proper keying effect accordingly.



## Flex™ and Downstream Key: Talk Show and Interview TV Show



## Flex™ and Chroma Key: Educational Program



## Flex™, Chroma Key, Luma Key and PIP: Cultural Program or Live Sports Program



### Assigning a video source to a PIP window using shortcut keys

In addition to assigning a video source to a **Flex™ output window** using the **OSD MENU**, the user can also use shortcut keys to easily switch between different **Flex™ output window sources**. Press and hold **KEY 1-4 PVW** buttons, and the program row will be backlit red. Press the program row buttons to change the **Flex™ output window** content.

### Simultaneously Enabling up to Eight PIP Windows

The HS-3200 allows you to enable up to eight PIP windows at the same time. This can be achieved by enabling the **Flex™ output** along with the **four keyers** built into the **HS-3200**. Before using this feature, the four keyers must be set to PIP mode and the four FLEX windows must be adjusted and positioned accordingly. The steps outlined below will guide you in configuring the eight PIP windows.

1. Enable **Flex™** output on PGM or PVW window (press **SHIFT** and while holding down the **SHIFT** button, press the **FLEX** button). This will display the **Flex™** output layout on either the PVW or PGM screen so that you will be able to configure the **Flex™** output windows while viewing the changes.
2. Pre-configure the four **Flex™** output windows in the **P-in-P** sub menu by adjusting the size and position of the corresponding windows. Remember to modify the luma key parameters accordingly. Note that you can change the **Flex™** output window content in the **Flex Src** sub menu.

P-in-P	Keyer	Flex PinP 1		Fine	Normal
	Position	X 20%	Y 10%	Size	40%
	Border	Normal			
	Luma	100%	Sat 80%	Hue	0
	Width	2%	Soft 0%	Opac	100%

	<b>Shade Matte</b>	<b>Luma</b> 100%	<b>Sat</b> 80%	<b>Hue</b> 60	
		<b>Shade Soft</b> 2%	<b>Shade Pos</b> 50	<b>Direction</b> 35	
	<b>Crop</b>	<b>Left</b> 0%	<b>Right</b> 0%	<b>Size</b> 0%	
		<b>Top</b> 0%	<b>Bot</b> 0%	<b>Soft</b> 0%	

3. Open the **Keyer** sub menu, set Keyers 1 – 4 to **PIP** mode and enable **Luma Key**.

<b>Keyer</b>	<b>Keyer</b>	<b>Key 1</b>	Normal	
	<b>Keyer Ctrl</b>	Luma	P-in-P	<b>Opac</b> 100%
		<b>Lift</b> 0%	<b>Gain</b> 1.0	<b>Invert</b> Off
	<b>Key Source</b>	<b>Input 1</b>	<b>Fill</b> Black	
	<b>Mask</b>	<b>Left</b> 0%	<b>Right</b> 0%	
		<b>Top</b> 0%	<b>Bot</b> 0%	

4. Adjust the P-in-P windows in the P-in-P sub menu.

<b>P-in-P</b>	<b>Keyer</b>	<b>Key 1</b>		<b>Fine</b>	Normal
	<b>Position</b>	<b>X</b> 20%	<b>Y</b> 10%	<b>Size</b>	40%
	<b>Border</b>	<b>Normal</b>			
		<b>Luma</b> 100%	<b>Sat</b> 80%	<b>Hue</b>	0
		<b>Width</b> 2%	<b>Soft</b> 0%	<b>Opac</b>	100%
	<b>Shade Matte</b>	<b>Luma</b> 100%	<b>Sat</b> 80%	<b>Hue</b>	60
		<b>Shade Soft</b> 2%	<b>Shade Pos</b> 50	<b>Direction</b>	35
	<b>Crop</b>	<b>Left</b> 0%	<b>Right</b> 0%	<b>Size</b>	0%
		<b>Top</b> 0%	<b>Bot</b> 0%	<b>Soft</b>	0%

5. After the **Flex™** output and the four PIP windows are successfully configured, enable the **Flex™** output by pressing the **Flex™** button while holding down the **SHIFT** button, and then press **KEY1 PGM** to **KEY4 PGM** buttons to activate the four PIP windows on the **Program** Output. The diagrams below provide an example of an eight PIP window display.



## 6.5 Shortcut Keys to assigning Output Sources

In general, the HS-3200 offers 9 output ports (**SDI 1 – 6 / HDMI 1-3**) and all 9 ports can be configured to output one of the following:

- Flex Src 1/2
- Still 2
- Still 1
- Input 1 – 12
- CLN PVW (Clean PVW)
- CLN PGM (Clean PGM)
- PG + DSK
- PVW
- PGM
- MultiV2 (Multi view 2)
- MultiV (Multi view)

In addition to setting the source of these 9 output ports in **OSD menu → Outputs → Output**, you can also use the shortcut keys on the control panel to assign the output sources. The instructions are outlined as follows:

1. The diagram below depicts the corresponding buttons for selecting the respective output ports as well as the video sources. The program row on the top allows you to first select the output port and the preset row below allows you to then assign a video source to the selected output port.

**Note: Pressing the BLK/MATTE button switches between two different groups of video sources.**

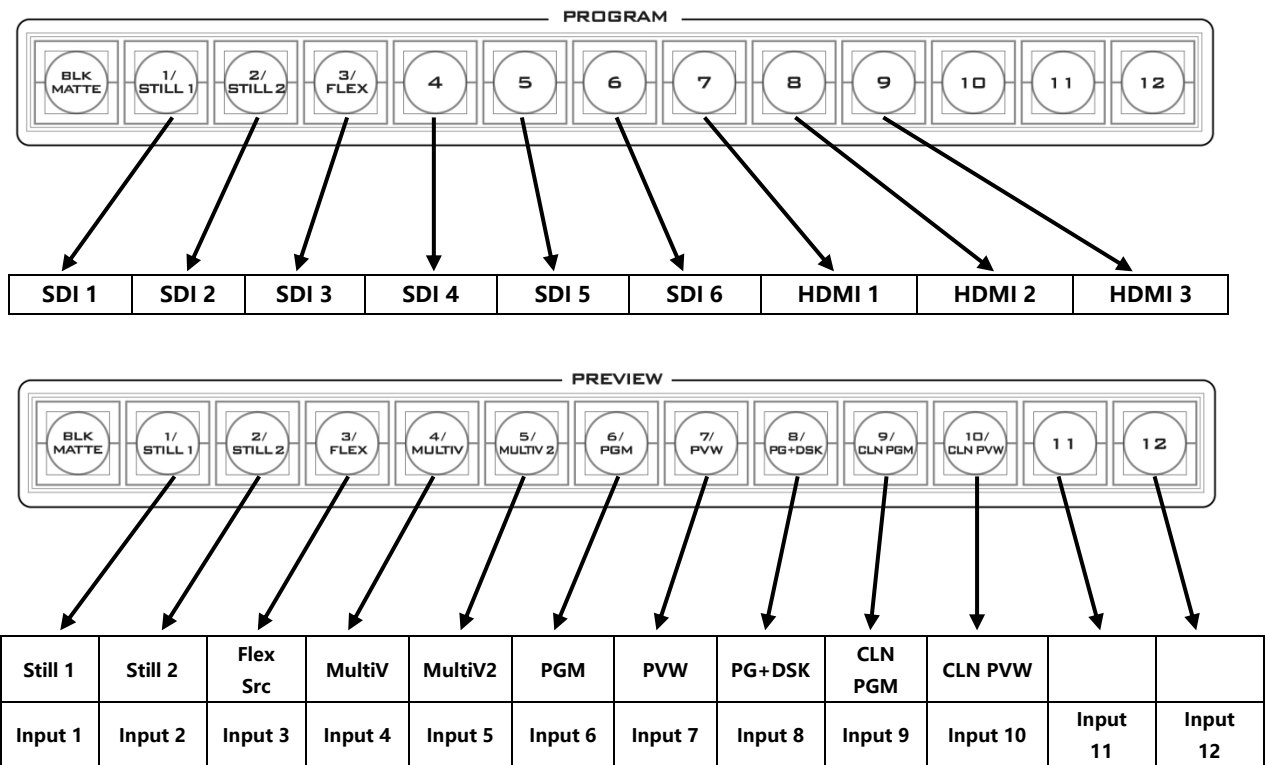

2. Upon pressing the FS/AUX button, you will see the following button LED behavior:
  - Buttons 1 – 9 on the program row turn solid red except for Button 1 which should be flashing by default.
  - Buttons BLK/MATTE – 10 on the preset row should turn solid blue except for one flashing button that is the video source assigned to the output port selected on the program row.
3. Press one of buttons 1 – 9 on the program row to select an output port. The selected button should turn flashing red.
4. Press one of buttons 1 – 10 on the preset row to select a video source; the corresponding video sources are listed as follows:
  - 1: Still 1
  - 2: Still 2
  - 3: Flex Src
  - 4: MultiV
  - 5: MultiV2
  - 6: PGM
  - 7: PVW
  - 8: PG+DSK
  - 9: CLN PGM
  - 10: CLN PVW

Once selected, the button should turn flashing blue.



5. To select input 1 – 12 video sources, you will need to press the **BLK/MATTE** button to switch to another group of video sources. All buttons on the preset row should turn solid green. Press the corresponding button to select the video source and the selected button should turn flashing green, indicating that the assignment is successful. Button 1 corresponds to input 1, button 2 corresponds to input 2 and etc.
6. Press the **FS/AUX** button to deactivate the shortcut keys.

## Chapter 7 Video Streaming and Recording

The HS-3200 Portable Video Studio includes a built-in Video Streaming Server (NVS-31) allowing the user to stream and record your program at the same time. From any SDI/HDMI input sources, the Datavideo's video streaming server generates an H.264 encoded stream that is compliant with RTSP or RTMP(S) protocols. While encoding the video at bit rates appropriate for live streaming, the Datavideo NVS-31 concurrently records a high-quality MP4 file to an SD card.

**Note:** *The built-in video streaming server and recording device are referred to as NVS-31.*

### 7.1 Streaming Network Connection and Device Search

This section details how to connect the NVS-31 to a network with or without a DHCP server, and describes how to acquire the NVS-31's IP address.

#### **Connecting to a DHCP Network (DHCP Mode)**

Follow the following procedure to scan your DHCP network for connected NVS-31 devices.

**Note:** *The NVS-31 will be automatically assigned an IP address upon connection to the DHCP network.*

1. Connect the NVS-31's stream port to the network via an Ethernet cable.
2. Turn on the HS-3200's power and the NVS-31 will also be turned ON in the DHCP mode by default.
3. Connect the laptop to the same network that the NVS-31 is connected to and download the free IP Finder utility program.
4. Double click the IP Finder utility program icon to open the IP Finder interface.
5. Click the **SCAN** button to start searching for connected devices.

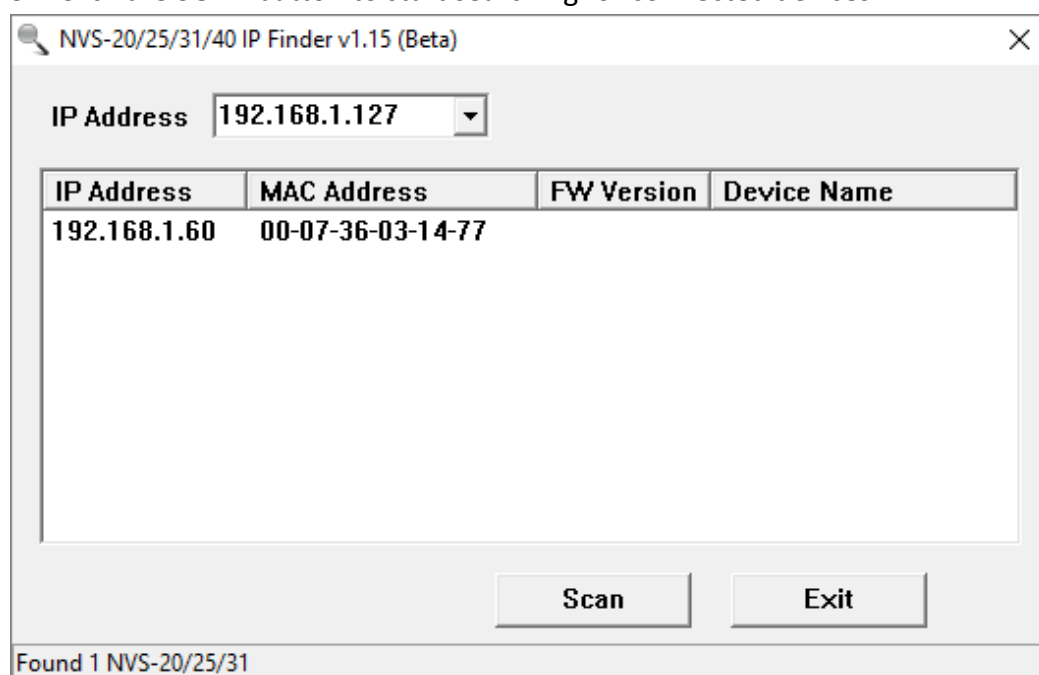
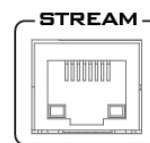

## Connecting to a NON-DHCP Network (Static IP)

Upon connection to a non-DHCP network, the NVS-31 will not be assigned of any IP addresses. As such it is recommended that you manually assign a fixed IP address to the device or use the default IP address (**192.168.1.60**).

### Default Fixed IP

Default Fixed IP is primarily used in point-to-point connection, such as connecting the PC to the NVS-31 directly. In a non-DHCP environment, the NVS-31 works in fixed IP mode only. To configure the NVS-31 to the **default IP**, please follow the steps outlined below:

1. Connect the NVS-31's stream port to the network via an Ethernet cable.
2. Turn on the HS-3200's power and the NVS-31 will also be turned ON in the DHCP mode by default.
3. Search for the NVS-31 device according to the method as detailed in the previous DHCP section. Once found, log into the user interface on the web browser.
4. Enter the system page by clicking the "System" tab on the home of the user interface.
5. In the "Network Setting", disable the DHCP mode.
6. You will then be allowed to manually enter the static IP address once the DHCP mode is disabled. The static IP is 192.168.1.60 by default. The subnet mask and default gateway are 255.255.255.0 and 192.168.1.254 respectively.

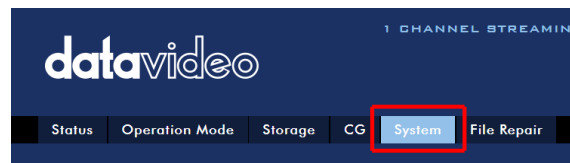
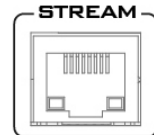

**Tip: If you forget or lose the IP address, do the following to reset the network settings.**

- Turn off the switcher.
- Press the **RECORD** and **STREAM** buttons at the same time then turn ON the power of the switcher
- Wait for about five seconds and release the button push as soon as you see the **RECORD** and **STREAM** button LEDs light up.
- The IP address should be the default IP which is **192.168.1.30**.

### Troubleshooting the Network Connection

Connect the NVS-31 to the network and open the IP Finder utility program. Scan for the device. If not found, it is possible that your network is not assigning IP addresses. Reasons of this are outlined as follows:

- Router or DHCP server is not connected to the network.
- New devices are blocked by the network administrator.
- Anti-virus software or the firewall blocks the communication.

Solve the problem by trying the following:

- Turn off the router, wait for 10 seconds then turn on the router again.

- Reset the NVS-31 to the factory default:
  - Turn off the switcher.
  - Push the **Record and Stream** buttons simultaneously while turning on the switcher's power.
  - Wait for about five seconds and release the button push as soon as you see the **RECORD** and **STREAM** button LEDs light up.
- Reboot the PC.

If the problem still persists, try the following ways:

- Temporarily shut down the anti-virus software or firewall.
- Make sure no other devices are connected to the LAN (wired or wireless) because this may result in IP conflicts.

After trying all methods and if the problem is still not solved, the NVS-31 video streaming server offers the fixed IP feature that allows you to establish direct connection to the NVS-31. The default IP address is 192.168.1.60.

This method allows you to configure the NVS device to the IP range of your network so that you do not need a DHCP server to gain access to the NVS device.

- Connect your PC to the NVS device directly using an Ethernet cable (not necessarily a crossover cable).

Next, change the network settings of your PC or laptop.

- Click START located at the bottom left corner of your screen.
- On the text bar, enter Network Connections then click the icon that appears.
- Double click the network adapter that connects your PC or laptop to the network.
- Click the "**Properties**" button.
- Select "**Internet Protocol Version 4 (TCP/IPv4)**" option and click the "**Properties**" button.
- Check the "**Obtain an IP address automatically**" option.
- Enter IPv4 settings:
  - IP Address: 192.168.1.2
  - Subnet Mask: 255.255.255.0 (System default is 255.255.255.0)
  - Default Gateway: Not required for one-to-one connection.

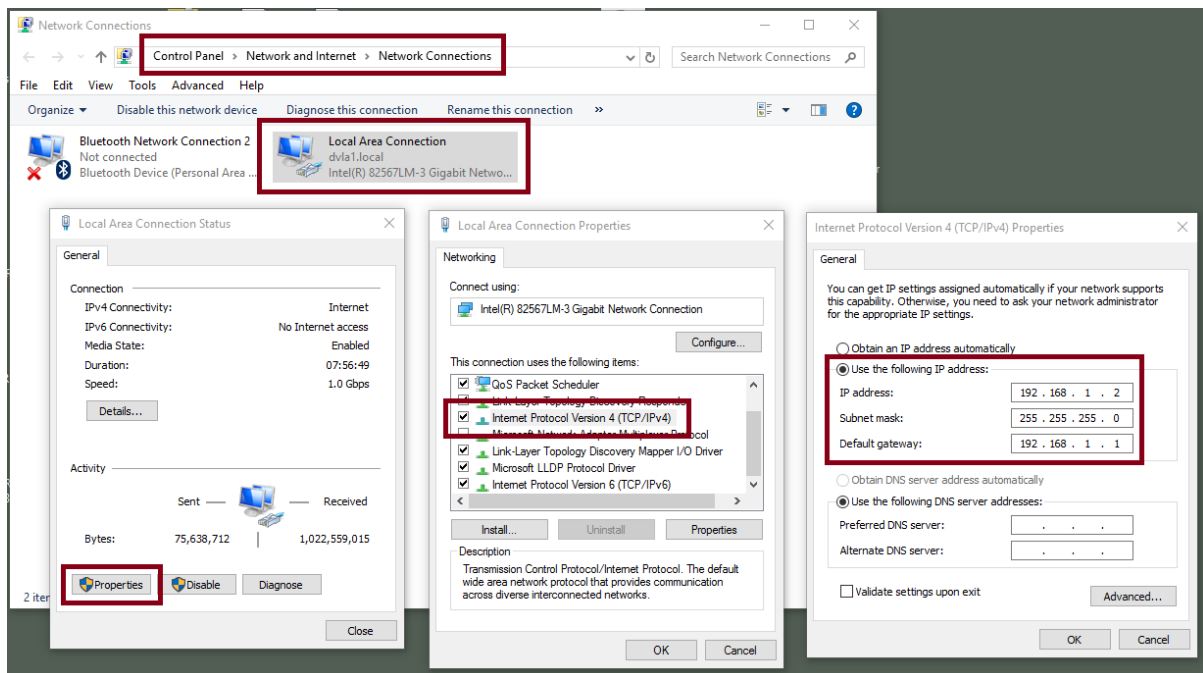

**Note: Please write down the IPv4 address previously entered as it may be needed after you are done with streaming or recording.**

- The NVS-31 should now be connected with an IP address of 192.168.1.60.
  - If the NVS-31 still cannot connect, simply restore the NVS-31 to the factory defaults.
    - Turn off the switcher.
    - Push the **Record and Stream** buttons simultaneously while turning on the switcher's power.
    - Wait for about five seconds and release the button push as soon as you see the **RECORD** and **STREAM** button LEDs light up.
    - Make sure no other devices are connected to the LAN (wired or wireless) because this may result in IP conflicts.
- Login the NVS-31 via a web browser.
  - Default user name is **admin**
  - Default password is **000000**
- Click the "**System**" tab then on the system page, enter network settings such as static IP and default gateway. Make sure that the default gateway matches your connected network and no device shares the same IP as the NVS-31.
 

For example, if your router's default gateway IP is 10.10.1.1, then in the default gateway field, you should also enter 10.10.1.1. Then set the IP address of the NVS-31 to 10.10.1.X, which can range from 10.10.1.2 to 10.10.1.255. Pick an unused IP address.

**Network Setting**

<p>DHCP</p> <p>Enable(DNS AUTO) ▼</p>	<p>Static IP</p> <p>192.168.1.60</p>
<p>Subnet Mask</p> <p>255.255.255.0</p>	<p>Default Gateway</p> <p>192.168.1.254</p>
<p>Primary DNS</p> <p></p>	<p>Secondary DNS(Alternative)</p> <p></p>
<p>MAC ADDRESS</p> <p>00:07:36:03:C0:20</p>	

- DHCP: Disable
- Static IP: X.X.X.Y; the first three decimal numbers must be the same as your router or switch. The number Y must be a number not used by any devices connected to the network.
- Subnet Mask: 255.255.255.0
- Default Gateway: Z.Z.Z.Z; same as the gateway IP of your router or switch.

**Note: Some router may require special gateway IP setting; instead of the standard 192.168.1.1. Therefore, you should check the network properties on the PC before switching to the fixed IP mode.**

**For example, some routers have a gateway IP of 192.168.1.254 and as a result, the default gateway and primary DNS fields on the NVS-31 must also be configured to 192.168.1.254.**

- Primary DNS: Same as the default gateway IP, which, if causing issues, can be changed to 8.8.8.8 or 8.8.8.4 (Public DNS provided by Google).
- Click the “**Submit**” button to save the network settings.
- Reconnect the PC and the NVS-31 to the network.
- Restore the PC’s original network settings.
- Shut down the HS-3200; wait for approximately five seconds before turning the HS-3200 back ON.
- You should be able to access the NVS-31 through the fixed IP address.

### ***Advanced Troubleshooting***

If you still are unable to connect, please try the following:

- Use the ARP table to search for the encoder’s MAC address; the device’s MAC address is on the print label at the bottom of your HS switcher.
- MAC address starts with **00:07:36:03:xx:xx**.
  - Switcher’s MAC address starts with 00:07:36:07:xx:xx (HS-3200 and HS-3200 only)

- On the command prompt (terminal on MAC OS), enter "**arp -a**" then press enter key to display an ARP list. See if the NVS-31 is successfully connected to the network.
- Execute **services.msc**, and on the right column of the "**Services**" window, locate "**DHCP Client**" then click "**Restart**".
- On the command prompt, enter **ipconfig/flushdns** followed by **ipconfig/release** and **ipconfig/renew**.

## 7.2 Web User Interface

By now, we have obtained the IP addresses of the PC and the NVS-31. Enter the NVS-31's IP address into the address bar of a browser then hit the **ENTER** button. Login by entering the user name as well as the password into a pop-up dialogue box as shown below.

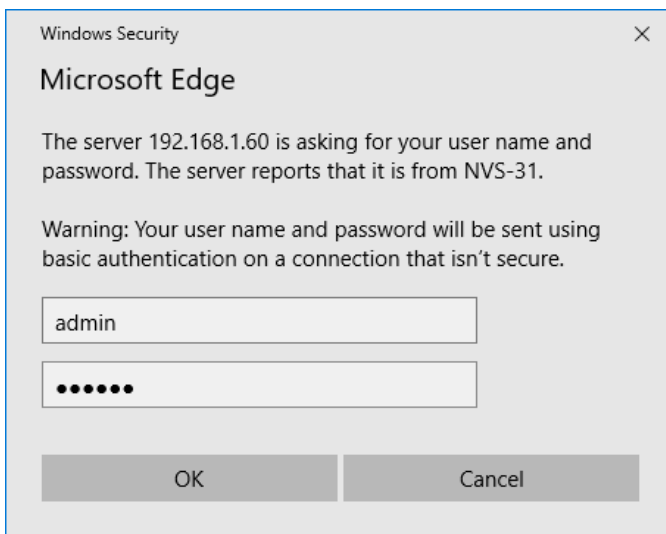

**Username: admin**

**Password: 000000**

Click **OK** to login. Once logged in, the first page that appears will be the **Status** page.

### Status

You will see the **Status** page immediately after logging into the NVS-31 web UI. On the Status page, you will be able to view the **Operation Mode**, **Video Resolution**, **Stream Settings** (RTSP/RTMP(S)/HLS/SRT/TS), **Record Settings**, **Record Media** and **Messages**.



**Note: The NVS-31 web UI does not update automatically so to learn the latest device status, please refresh the page manually.**

While monitoring streaming and recording, please update the page periodically regardless of how you operate the device (using the device’s physical buttons only or using the device’s physical buttons along with the web UI). This ensures the page is always displaying the most up-to-date information.

If an error occurs, the error code will be shown in the “**Messages**” field. The device’s error codes are listed in the table below.

<b>Error Messages</b>	<b>Descriptions</b>	<b>Error Code</b>
STR_UP_ETH_LINK_DOWN	Ethernet Link Down	133
STR_UP_ETH_LINK_RESTORE	Ethernet Link Up from Down	134
STR_UP_ETH_CONN_ERR	RTMP Cannot Publish (Retrying)	140
STR_UP_ENC_START_ERR	Encoder Start Failed	129
STR_UP_ENC_BUFF_ERR	Encoder Buffer Error	130
STR_RUN_ETH_LINK_DOWN	Ethernet Link Down (Dropped)	133
STR_RUN_ETH_CONN_ERR	RTMP Drop Connection (Retrying)	140
STR_RUN_ENC_BUFF_ERR	Encoder Buffer Error	130
STR_RUN_PROG_BUFF_ERR	Streamer Buffer Error	137
STR_RUN_PROG_SOCKET_ERR	Streamer Socket Error	140
STR_STOP_PROG_EXIT_ERR	Streamer Stop Failed	141
REC_UP_DISK_ERR	Disk Bad Sectors/Read Only/File System Error	148
REC_UP_DISK_EMPTY	No Disk	144
REC_UP_ENC_START_ERR	Encoder Start Failed	129
REC_UP_ENC_BUFF_ERR	Encoder Buffer Error	130
REC_UP_PROG_START_ERR	Recorder Start Failed	148
REC_UP_PROG_BUFF_ERR	Recorder Buffer Error	154
REC_RUN_DISK_FULL	Disk Full	151
REC_RUN_ENC_BUFF_ERR	Encoder Buffer Error	130
REC_RUN_PROG_WRITE_ERR	Recorder Write Failed	153
REC_RUN_PROG_BUFF_ERR	Recorder Buffer Error	137
REC_STOP_DISK_EXIT_ERR	Unmount Disk Failed	156
REC_STOP_PROG_EXIT_ERR	Recorder Stop Failed	157



## Operation Mode

Click the **Operation Mode** tab on the tool bar to open the operation mode configuration page.

The screenshot displays the 'Operation Mode' configuration page for the NVS-31. At the top, there are navigation tabs: Status, Operation Mode (selected), Storage, CG, System, and File Repair. The page title is '1 CHANNEL STREAMING ENCODER / RECORDER NVS-31' and the language is set to 'English'. The firmware version is 'FW20190618NVS\_V06'. The main configuration area is divided into three sections: 'Record and Stream', 'Record Only', and 'Stream Only', each with a radio button. The 'Record and Stream' mode is selected. Below these are two columns of settings: 'Record Setting' and 'Stream Setting'. The 'Record Setting' includes Resolution (Same as Input), Framerate (30.00), Profile (High), Video Bitrate (6 M), Audio Bitrate (128 K), and GOP (60). The 'Stream Setting' includes Resolution (Same as Input), Framerate (30.00), Profile (High), Video Bitrate (1.5 M), Audio Bitrate (128 K), and GOP (60). Other settings include Bitrate Mode (Mid), Auto Stream (OFF), File Name (RECORD), Stream Type (HLS), Video Only (OFF), File Size (4G), and Recording File (None). At the bottom, there are buttons for Start, Stop, and Apply.

The NVS-31 offers the following operation modes:

- **Record and Stream:** Streaming and recording functions are enabled at the same time.
- **Stream Only:** Only streaming mode is enabled.
- **Record Only:** Only recording mode is enabled.

In each mode, the user will be allowed to customize various stream and record settings.

In the Stream Only mode, settings such as **Resolution**, **Frame Rate**, **Profile**, **Video Bitrate (bps)**, **Audio Bitrate (bps)**, **GOP** and **Stream Type** can be configured.

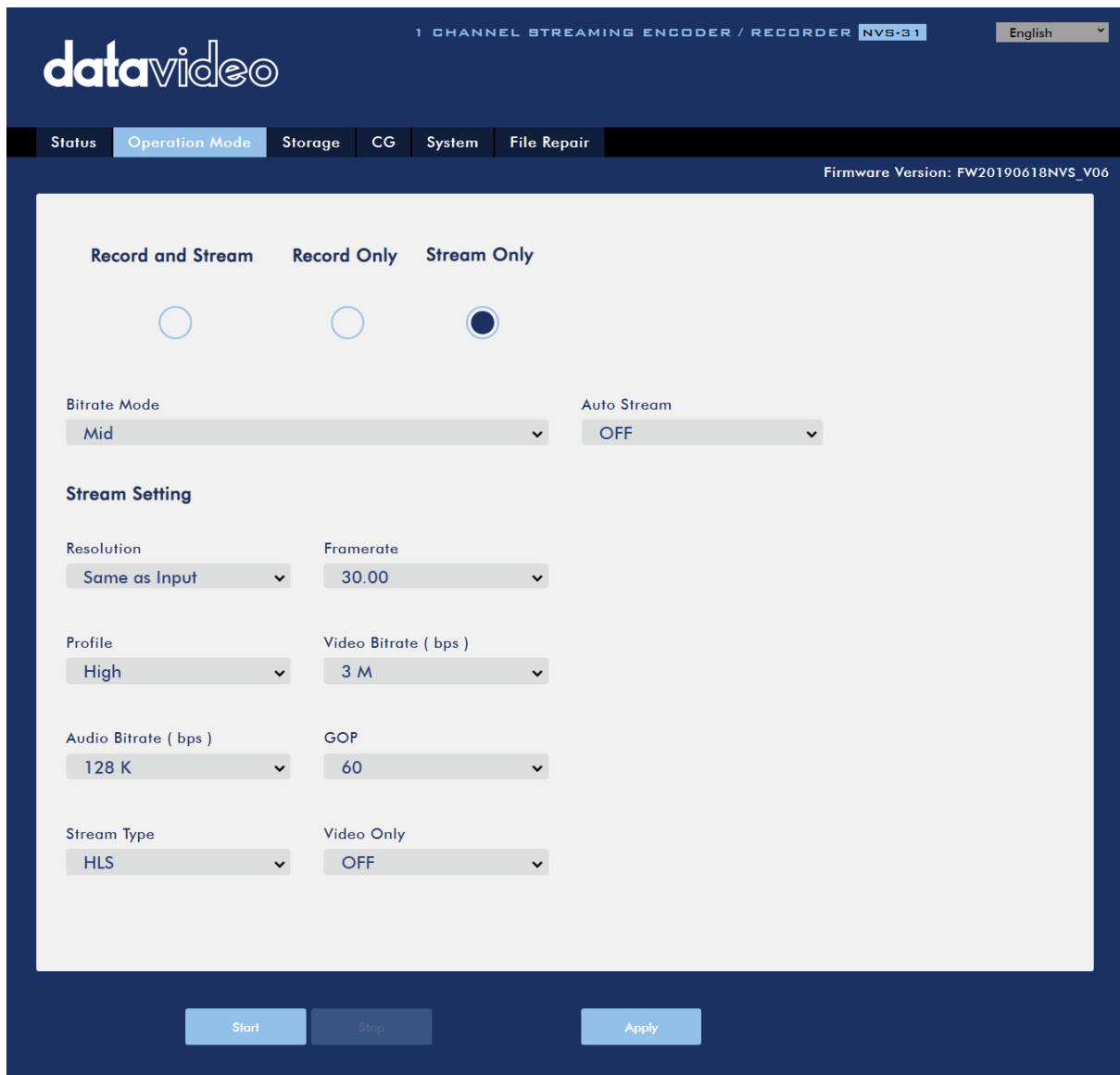

Five stream types are available on the NVS-31 and they are **RTSP**, **RTMP(S)**, **HLS**, **SRT** and **TS**. See [Section 6.3](#) for details.

Click the **“Apply”** button to apply the new stream settings. Click the **“Start”** button to open the stream and the **“Stop”** button to end the stream.



As for recording, the settings are **Resolution**, **Frame Rate**, **Profile**, **Video Bitrate (bps)**, **Audio Bitrate (bps)**, **GOP**, **File Name** and **File Size**.

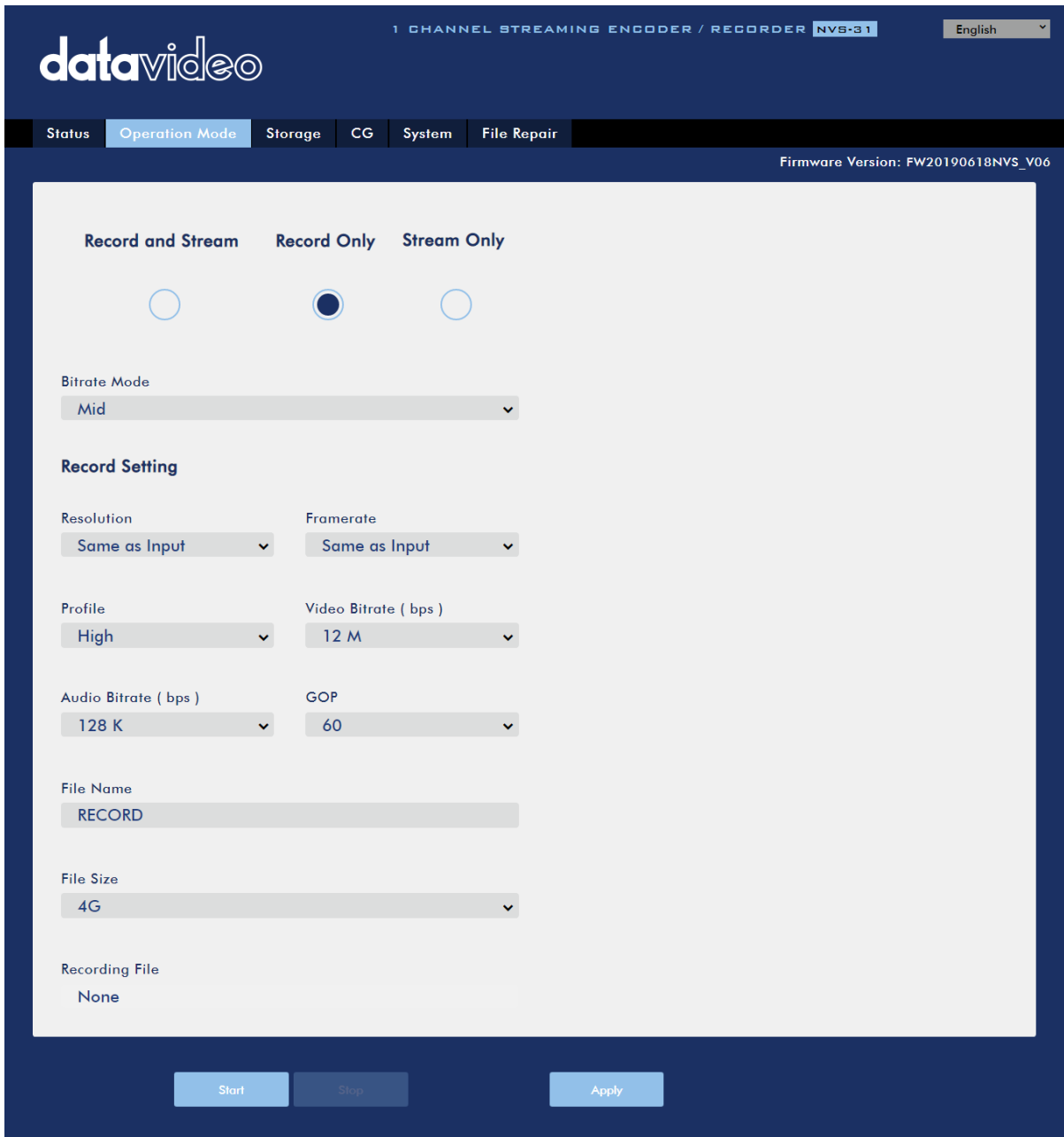

Click the **“Apply”** button to apply the new record settings. Click the **“Start”** button to start recording and the **“Stop”** button to stop recording.



## Stream and Record Settings

In the section, you will be introduced various setting options of stream and record functions.

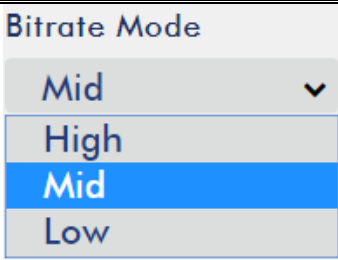
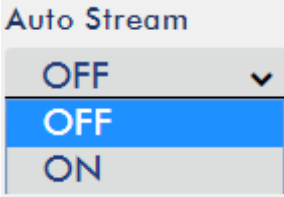
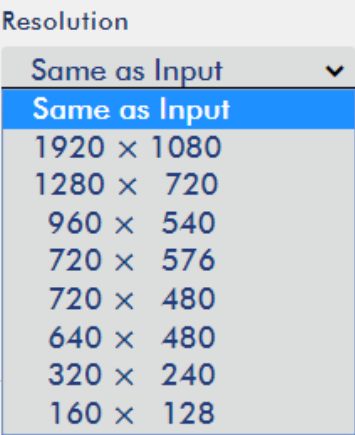
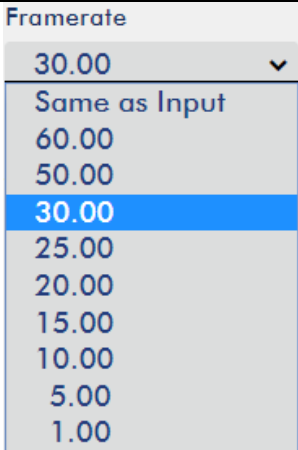
Stream Encoder Settings	
	<p><b>Bitrate Mode</b></p> <p>The bitrate mode sets the video bitrate mode for your video stream. The available modes are high, mid and low.</p> <p><b>Note: You can also switch between different bitrate modes by pressing the Bitrate button on the Record/Stream panel. See <a href="#">Section 7.4</a> for details.</b></p>
	<p><b>Auto Stream</b></p> <p>If the Auto Stream is enabled, in the event of power outage, the stream will be automatically restored after the switcher is powered ON again.</p>
	<p><b>Resolution</b></p> <p>The first step of encoder setup is to adjust the image size. It is best to either match your original video source or scale it down. For example, capture at HD 720 and stream at HD 720. Or capture at HD 720 and stream at 540 (high).</p> <p>You should never be scaling up and streaming at a higher resolution than your original video source. For example, it does not make sense to capture at 720 and stream at 1080. Note that you will also have no gain in quality and you are using more bandwidth than is necessary for your viewers.</p> <p>You should also be aware that higher resolutions require greater processing power to encode the stream. Attempting too high of a resolution on too little processing power can result in degraded image quality and corrupted or interrupted streams or recordings.</p>
	<p><b>Frame Rate</b></p> <p>Select a frame rate from the drop-down menu for video streaming. Note that frame rates should always match the frame rate of the video source.</p>

<p>Profile</p> <ul style="list-style-type: none"> <li>Main ▾</li> <li>High</li> <li><b>Main</b></li> <li>Baseline</li> </ul>	<p><b>Profile</b></p> <p><b>Profile</b> sets the H.264 encoding profile for your stream. The available options are <b>Baseline</b>, <b>Main</b>, and <b>High</b>. Typically, <b>High</b> profile provides the best image quality and is suitable in most instances. However, depending on the decoder used when viewing the stream, such as with mobile devices, a Main or Baseline profile may be required.</p>
<p>Video Bitrate ( bps )</p> <ul style="list-style-type: none"> <li>12 M ▾</li> <li>15 M</li> <li><b>12 M</b></li> <li>10 M</li> <li>8 M</li> <li>7 M</li> <li>6 M</li> <li>5 M</li> <li>4 M</li> <li>3 M</li> <li>2.5 M</li> <li>2 M</li> <li>1.5 M</li> <li>1 M</li> <li>512 K</li> <li>256 K</li> </ul>	<p><b>Video Bitrate (bps)</b></p> <p>The bitrate of the video specifies the amount of information stored in the video. The higher the bitrate is, the clearer the video is. However, when choosing your encoding settings for streaming, you should first check your available upload bandwidth. A good rule of thumb is for the bitrate of your stream to use no more than 50% of your available upload bandwidth capacity on a <b>DEDICATED</b> line. For example, if the result you get from a speed test shows that you have 2Mbps of upload speed available, your combined audio and video bitrate should not exceed 1Mbps.</p> <p>Usually high bitrate means good image quality; however, there are also exceptions. For example, SD video may appear acceptable at 1000 Kbps (1M) but HD video is unacceptable at 1000 Kbps. Therefore we recommend the following settings for your video bitrate:</p> <ul style="list-style-type: none"> <li>• When NVS-31 is in record-only mode, the recommended video bitrate is 16 Mbps.</li> <li>• When NVS-31 is in stream-only mode, the recommended video bitrate is 10 Mbps.</li> <li>• When NVS-31 streams and records simultaneously, sum of the stream and record video bitrates should not exceed 12Mbps.</li> </ul>
<p>Audio Bitrate ( bps )</p> <ul style="list-style-type: none"> <li>128 K ▾</li> <li>384 K</li> <li>256 K</li> <li><b>128 K</b></li> <li>64 K</li> <li>32 K</li> </ul>	<p><b>Audio Bitrate (bps)</b></p> <p>The NVS-31 offers the user the following audio bitrates at which you may want to stream the audio. It is recommended to select 128Kbps or higher.</p>

<p><b>GOP</b></p> <p>60</p> <p>180</p> <p>160</p> <p>140</p> <p>120</p> <p>100</p> <p>60</p> <p>50</p> <p>30</p> <p>25</p> <p>20</p> <p>15</p> <p>10</p> <p>5</p> <p>3</p> <p>2</p> <p>1</p>	<p><b>GOP</b></p> <p>GOP pattern with longer GOP length encodes video very efficiently. Shorter GOP lengths usually work better with video that has quick movements, but they do not compress the data rate as much. Depending on your applications, the NVS-31 offers the user 16 GOP sizes ranging from 1 to 180.</p>
<p><b>Stream Settings</b></p>	
<p><b>Stream Type</b></p> <p>RTSP</p> <p>RTSP</p> <p>RTMP</p> <p>TS</p> <p>HLS</p> <p>SRT</p>	<p><b>Stream Type</b></p> <p>The NVS-31 offers the user six stream types. There are <b>RTSP, RTMP(S), TS, HLS, SRT</b> and <b>Youtube</b>.</p> <p>Please note that when streaming, the NVS-31 converts video into data, which are sent across an IP network. High bitrates consume more bandwidth across the IP network. In a gigabit office LAN, high bitrate may not be a concern and Speed/Bandwidth is therefore not a limitation in an NVS-31 application environment.</p> <p>If your available bandwidth is limited, you should reduce both your resolution and your bitrate accordingly. A good rule of thumb is for the bitrate of your stream to use no more than 50% of your available upload bandwidth capacity on a dedicated line. For example, if the result you get from a speed test shows that you have 2Mbps of upload speed available, your combined audio and video bitrate should not exceed 1Mbps.</p>
<p><b>Stream Type – RTSP</b></p>	
<p><b>RTSP Port</b></p> <p>554</p>	<p><b>RTSP Port</b></p> <p>RTSP Port is 554 by default.</p>

<p>RTSP HTTP Port</p> <p>8000</p>	<p><b>RTSP HTTP Port</b> RTSP HTTP port is 8000 by default.</p>
<p>Video Only</p> <p>OFF <input type="checkbox"/></p> <p>OFF <input checked="" type="checkbox"/></p> <p>ON <input type="checkbox"/></p>	<p><b>Video Only</b> Enable this option if you just want to stream the video without the audio.</p>
<p><b>RTSP Username/Password</b> The account and password are <b>root</b> by default.</p> <p>RTSP Account: root      RTSP Password: root</p>	
<p><b>Stream Type – RTMP(S)</b></p>	
<p>RTMP URL</p> <p><input type="text"/></p>	<p><b>RTMP URL</b> Enter the RTMP URL obtained from any live streaming platform such as Ustream.  <b>Note: The NVS-31 supports RTMP(S) Publish only and not RTMP(S) Local.</b></p>
<p>RTMP URL</p> <p><input type="text"/></p>	<p><b>Stream Name</b> Enter the stream name or key from any live streaming platform such as Ustream.</p>
<p>Account</p> <p><input type="text"/></p>	<p><b>Account</b> Enter your RTMP account name.</p>
<p>Password</p> <p><input type="text"/></p>	<p><b>Password</b> Enter the password of your RTMP account.</p>
<p>Audio Only</p> <p>OFF <input type="checkbox"/></p> <p>OFF <input checked="" type="checkbox"/></p> <p>Video Only <input type="checkbox"/></p> <p>Audio Only <input type="checkbox"/></p>	<p><b>Audio Only</b> In this option, the user is allowed to choose to stream <b>Audio Only</b> or <b>Video Only</b>. If disabled, video and audio streams will be delivered simultaneously.</p>
<p><b>Stream Type – TS</b></p>	
<p>TS Port</p> <p>12345</p>	<p><b>TS Port</b> The TS port number is 12345 by default.</p>

<p><b>TS IP</b></p> <p>239.100.100.100</p>	<p><b>TS IP</b></p> <p>The TS IP address is 239.100.100.101 by default.</p>
<p>Video Only</p> <p>OFF <input type="checkbox"/></p> <p>OFF <input checked="" type="checkbox"/></p> <p>ON <input type="checkbox"/></p>	<p><b>Video Only</b></p> <p>Enable this option if you just want to stream the video without the audio.</p>
<p><b>Stream Type – SRT</b></p>	
<p><b>SRT Port</b></p> <p>9001</p>	<p><b>SRT Port</b></p> <p>The SRT port is 9001 by default.</p>
<p><b>Play URL</b></p> <p>srt://192.168.1.60:9001</p>	<p><b>Play URL</b></p> <p>A stream URL will be generated after the <b>Start</b> button is clicked.</p>
<p><b>Record Encoder Settings</b></p>	
<p><b>Bitrate Mode</b></p> <p>Mid <input type="checkbox"/></p> <p>High <input type="checkbox"/></p> <p>Mid <input checked="" type="checkbox"/></p> <p>Low <input type="checkbox"/></p>	<p><b>Bitrate Mode</b></p> <p>The bitrate mode sets the video bitrate mode for your video stream. The available modes are high, mid and low.</p> <p><b>Note: You can also switch between different bitrate modes by pressing the Bitrate button on the Record/Stream panel. See <a href="#">Section 7.4</a> for details.</b></p>
<p><b>Resolution</b></p> <p>Same as Input <input type="checkbox"/></p> <p>Same as Input <input checked="" type="checkbox"/></p> <p>1920 × 1080</p> <p>1280 × 720</p> <p>960 × 540</p> <p>720 × 576</p> <p>720 × 480</p> <p>640 × 480</p> <p>320 × 240</p> <p>160 × 128</p>	<p><b>Resolution</b></p> <p>Recording resolution is the number of pixels (dots) used to create an image. Higher resolutions use more pixels to create an image. This means that greater amounts of detail can be expressed in the image, but larger files sizes and a greater amount of storage (i.e. hard drive space) are required to save the images or video.</p>



<p>Framerate</p> <ul style="list-style-type: none"> <li>30.00 ▾</li> <li>Same as Input</li> <li>60.00</li> <li>50.00</li> <li style="background-color: #0070C0; color: white;">30.00</li> <li>25.00</li> <li>20.00</li> <li>15.00</li> <li>10.00</li> <li>5.00</li> <li>1.00</li> </ul>	<p><b>Frame Rate</b></p> <p>Frame rate greatly impacts the style and viewing experience of a video. Different frame rates yield different viewing experiences, and choosing a frame rate often means choosing between things such as how realistic you want your video to look, or whether or not you plan to use techniques such as slow motion or motion blur effects.</p> <p>Below is a list of common options for different applications:</p> <ul style="list-style-type: none"> <li>• <b>24fps</b> – This is the standard for movies and TV shows, and it was determined to be the minimum speed needed to capture video while still maintaining realistic motion.</li> <li>• <b>30fps</b> – Videos with a lot of motion, such as sports, will often benefit from the extra frames per second.</li> <li>• <b>60+fps</b> – Anything higher than 30fps is mainly used to create slow motion video or to record video game footage.</li> </ul>
<p>Profile</p> <ul style="list-style-type: none"> <li>High ▾</li> <li style="background-color: #0070C0; color: white;">High</li> <li>Main</li> <li>Baseline</li> </ul>	<p><b>Profile</b></p> <p><b>Profile</b> sets the H.264 encoding profile for your recorder. The available options are <b>Baseline</b>, <b>Main</b>, and <b>High</b>. Typically, <b>High</b> profile provides the best image quality and is suitable in most instances.</p>
<p>Video Bitrate ( bps )</p> <ul style="list-style-type: none"> <li>12 M ▾</li> <li>15 M</li> <li style="background-color: #0070C0; color: white;">12 M</li> <li>10 M</li> <li>8 M</li> <li>7 M</li> <li>6 M</li> <li>5 M</li> <li>4 M</li> <li>3 M</li> <li>2.5 M</li> <li>2 M</li> <li>1.5 M</li> <li>1 M</li> <li>512 K</li> <li>256 K</li> </ul>	<p><b>Video Bitrate (bps)</b></p> <p>The bitrate of the video specifies the amount of information stored in the video. The higher the bitrate is, the clearer the video is.</p> <p>Recommended video bitrate</p> <ul style="list-style-type: none"> <li>• <b>720P or lower</b> – 8 – 10 mbps</li> <li>• <b>1080P or higher</b> – 15 mbps or higher</li> </ul>

<p><b>Audio Bitrate ( bps )</b></p> <p>128 K ▾</p> <p>384 K</p> <p>256 K</p> <p>128 K</p> <p>64 K</p> <p>32 K</p>	<p><b>Audio Bitrate (bps)</b></p> <p>The NVS-31 offers the user the following audio bitrates at which you may want to record the audio. It is recommended to record at 128Kbps or higher.</p>
<p><b>GOP</b></p> <p>60 ▾</p> <p>180</p> <p>160</p> <p>140</p> <p>120</p> <p>100</p> <p>60</p> <p>50</p> <p>30</p> <p>25</p> <p>20</p> <p>15</p> <p>10</p> <p>5</p> <p>3</p> <p>2</p> <p>1</p>	<p><b>GOP</b></p> <p>GOP pattern with longer GOP length encodes video very efficiently. Shorter GOP lengths usually work better with video that has quick movements, but they do not compress the data rate as much. Depending on your applications, the NVS-31 offers the user 16 GOP sizes ranging from 1 to 180.</p>
<b>Record Settings</b>	
<p><b>File Name</b></p> <p>RECORD</p>	<p><b>File Name</b></p> <p>Enter the name of the recording file.</p>
<p><b>File Size</b></p> <p>4G ▾</p> <p>200M</p> <p>500M</p> <p>1G</p> <p>2G</p> <p>4G</p>	<p><b>File Size</b></p> <p>Select the file size of a single recording file.</p>
<p><b>Recording File</b></p> <p>None</p>	<p><b>Recording File</b></p> <p>Display the file that is currently being recorded.</p>

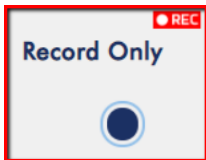

**Note:** The record function is activated after the Start button is clicked. The REC indicator will appear as shown on the left. Flashing indicates that the record function is starting. A solid color indicator means the record function has been activated successfully (The indicator flashing three times then turned off indicates errors). The activation time is approximately 2 to 3 seconds.

## Storage

The web UI of the HS-3200's built-in video streaming server (NVS-31) also displays storage device information, allowing the user to view the SD card status. The Status page of the web UI is shown in the diagram below.

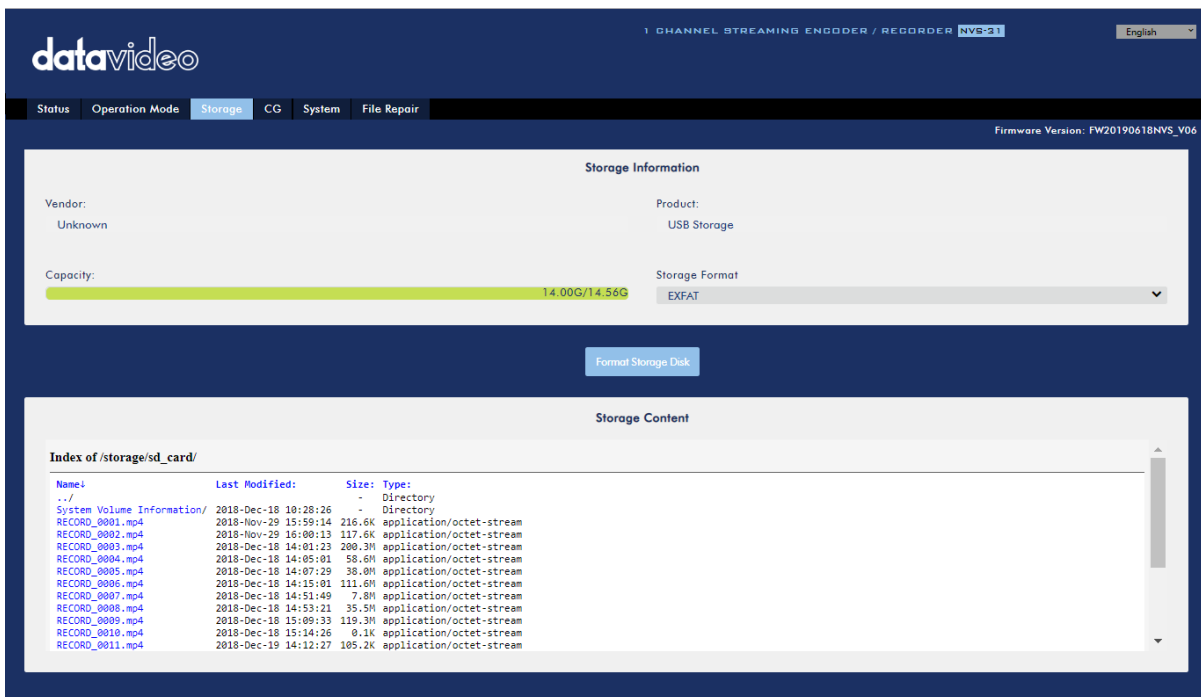

Storage Device Information	
<p><b>Vendor:</b> Unknown</p>	<p><b>Vendor</b> Display of the manufacturer's information.</p> <p><b>Note that you should only use Class 10 SD card or above. See <a href="#">Appendix 3 Recommended SD Cards</a> for a list of SD cards recommended by Datavideo.</b></p>
<p><b>Product:</b> USB Storage</p>	<p><b>Product</b> Display of the name of the SD card.</p>
<p><b>Capacity:</b> 14.00G/14.56G</p>	<p><b>Capacity</b> Display of the SD card's total capacity and the remaining capacity.</p>

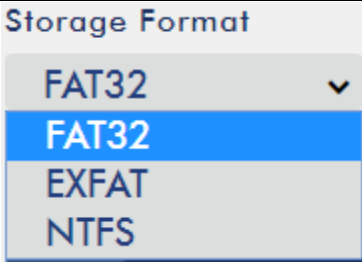
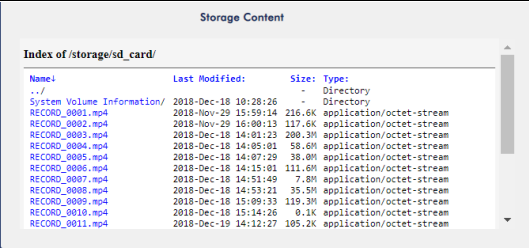
	<p><b>Storage Format</b> Select a storage format before clicking <b>Format Storage Disk</b> to format your SD card.</p> <ul style="list-style-type: none"> <li>FAT32</li> <li>EXFAT</li> <li>NTFS</li> </ul>
	<p><b>Storage Content</b> Display of the SD card content.</p> <ul style="list-style-type: none"> <li>File name</li> <li>Last Modified</li> <li>Size</li> <li>Type</li> </ul>

## CG

The CG function on the HS-3200's built-in video streaming server allows the user to place a textual layer on top of the video. The CG settings on the CG page are shown in the diagram below.

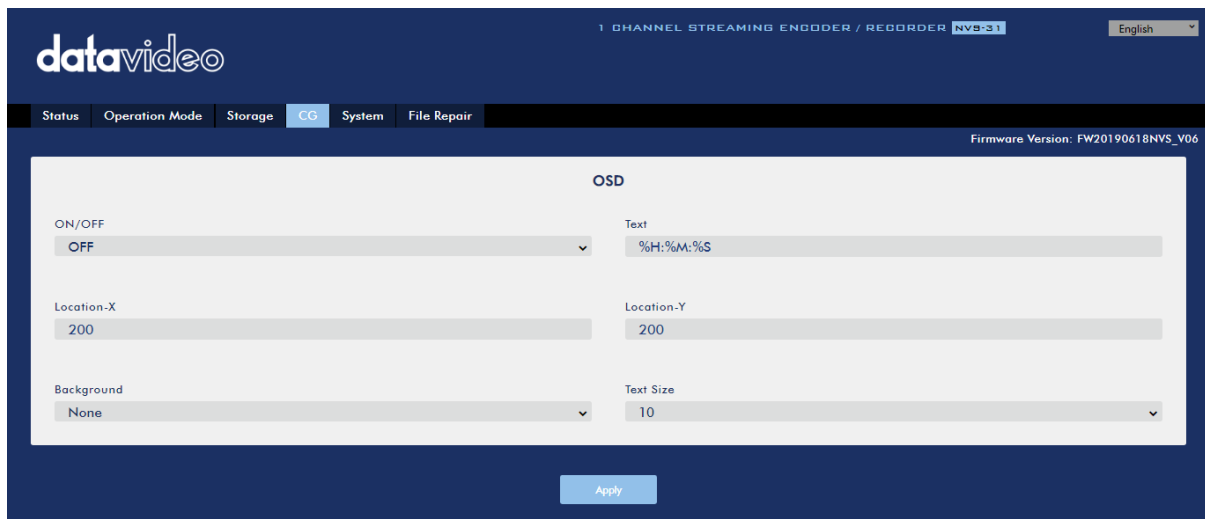

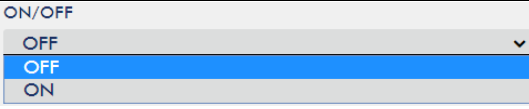
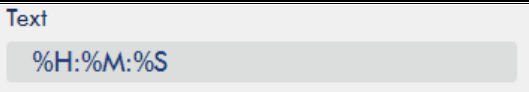
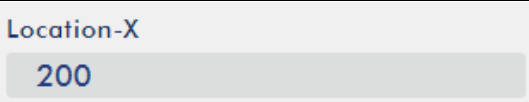
CG Settings	
	<p><b>CG Enable/Disable</b> Select <b>ON/OFF</b> from this drop-down menu to enable/disable the CG overlay function.</p>
	<p><b>Text</b> Enter the text of the CG overlay.</p>
	<p><b>Location-X</b> Enter the x-coordinate.</p>

<p>Location-Y</p> <p>200</p>	<p><b>Location-Y</b></p> <p>Enter the y-coordinate.</p>
<p>Background</p> <p>None</p> <p>None</p> <p>Black</p>	<p><b>Background</b></p> <p>You can either select a black background or none.</p>
<p>Text Size</p> <p>10</p> <p>8</p> <p>9</p> <p>10</p> <p>11</p> <p>12</p> <p>13</p> <p>14</p> <p>15</p> <p>16</p> <p>17</p> <p>18</p> <p>19</p> <p>20</p>	<p><b>Text Size</b></p> <p>Select the font size of your CG overlay text.</p>

## System

The system page of the HS-3200's built-in video streaming server allows the user to configure several network and system related settings such as **DHCP enable/disable, static IP address, subnet mask, default gateway, primary and secondary DNS**, and etc.

The system settings are **HLS preview enable/disable, time settings, firmware update, device name**, and **account login information**.

The system page is shown in the diagram below.

### Network Setting

DHCP	Static IP
Enable(DNS AUTO)	192.168.1.60
Subnet Mask	Default Gateway
255.255.255.0	192.168.1.254
Primary DNS	Secondary DNS(Alternative)
MAC ADDRESS	
00:07:36:03:AA:01	

Submit

### HLS Preview Setting

HLS Preview	Submit
OFF	

### Time Setting

Type	Timezone	Submit
Manually	UTC+8	
Date	Time	
2019-06-20	14:15:05	

### Firmware Update

File Path	Browse
	Update

### Device Name Setting

Device Name	Submit

### Account Setup

Original Account	Original Password	Apply

### System Control

Restore to Default System Reboot

Network Settings	
<p><b>DHCP</b></p> <p>Enable(DNS AUTO) ▼</p> <p>Enable(DNS AUTO)</p> <p>Enable</p> <p>Disable</p>	<p><b>DHCP IP Assignment</b></p> <p>Select an option from this drop-down menu:</p> <ul style="list-style-type: none"> <li>• Enable (DNS AUTO)</li> <li>• Enable</li> <li>• Disable</li> </ul>
<p><b>Static IP</b></p> <p>192.168.1.60</p>	<p><b>Static IP Address</b></p> <p>The static IP field will be activated for the user to manually enter an IP address once the DHCP is disabled. The static IP is 192.168.1.60 by default.</p> <p><b>Tip: If you do not know the device's IP address, you can always use the following method to reset the network settings.</b></p> <ul style="list-style-type: none"> <li>• Shut down the machine</li> <li>• Turn on the machine while holding down <b>RECORD</b> and <b>STREAM</b> buttons simultaneously.</li> <li>• Approximately after 5 seconds, release the <b>RECORD</b> and <b>STREAM</b> buttons as soon as the button LEDs are turned <b>ON</b>.</li> <li>• Fixed IP address is 192.168.1.60 by default.</li> </ul>
<p><b>Subnet Mask</b></p> <p>255.255.255.0</p>	<p><b>Subnet Mask</b></p> <p>Static IP address mode requires <b>subnet mask</b>, which is 255.255.255.0 by default.</p>
<p><b>Default Gateway</b></p> <p>192.168.1.254</p>	<p><b>Default Gateway</b></p> <p>Static IP address mode requires <b>default gateway</b>, which is 192.168.1.254 by default.</p>
<p><b>Primary DNS</b></p>	<p><b>Primary DNS (Optional)</b></p> <p>Primary DNS is required in static IP mode only but optional.</p>
<p><b>Secondary DNS(Alternative)</b></p>	<p><b>Secondary DNS (Optional)</b></p> <p>Secondary DNS is required in static IP mode only but optional.</p>
<p><b>MAC ADDRESS</b></p> <p>00:07:36:03:C0:20</p>	<p><b>MAC Address</b></p> <p>Display of NVS-31's MAC address.</p>

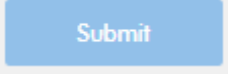
	<p><b>Submit Button</b> After the network settings are configured, click the <b>Submit</b> button to save the new settings.</p>
<p>HLS Preview</p> <p>OFF <input type="button" value="v"/></p> <p>OFF</p> <p>ON</p> <p><input type="button" value="Submit"/></p>	<p><b>HLS Preview</b> Here you will be able to enable/disable HLS preview. Click the <b>Submit</b> button to save the new settings.</p>
<p><b>Time Setting</b></p>	
<p>Type</p> <p>Manually <input type="button" value="v"/></p> <p>Automatically from the internet</p> <p>Manually</p>	<p><b>Type</b> In this drop-down menu, you can either select to allow the device to retrieve the time automatically from the Network Time Protocol (NTP) server or manually select a time zone from the Time Zone drop-down menu.</p>
<p>Timezone</p> <p>UTC+8 <input type="button" value="v"/></p> <p>UTC-12</p> <p>UTC-11</p> <p>UTC-10</p> <p>UTC-9</p> <p>UTC-8</p> <p>UTC-7</p> <p>UTC-6</p> <p>UTC-5</p> <p>UTC-4</p> <p>UTC-3</p> <p>UTC-2</p> <p>UTC-1</p> <p>UTC+0</p> <p>UTC+1</p> <p>UTC+2</p> <p>UTC+3</p> <p>UTC+4</p> <p>UTC+5</p> <p>UTC+6</p> <p>UTC+7</p> <p>UTC+8</p> <p>UTC+9</p> <p>UTC+10</p> <p>UTC+11</p> <p>UTC+12</p>	<p><b>Time Zone</b> Click the drop-down menu to select a time zone for your device.</p>
<p>Date</p> <p>2018-12-19</p> <p>Time</p> <p>15:16:38</p>	<p><b>Date/Time</b> Date and Time fields show the device's system date and time values.</p>



June 2019

Su	Mo	Tu	We	Th	Fr	Sa
						1
2	3	4	5	6	7	8
9	10	11	12	13	14	15
16	17	18	19	20	21	22
23	24	25	26	27	28	29
30						

You will see the calendar on the left after clicking the Date field. Simply click a day to set the date.

Click the **Submit** button to save the new settings.

### Firmware Update

**NVS-31 Firmware Update**  
Click the **Browse** button to search for the latest firmware file saved on the PC's hard disk. Click the **Update** button after the latest firmware file is uploaded.

### Device Name Setting

**Device Name Setting**  
Enter a name for this device and click the **Submit** button to write this name into the device.

### Account Setup

**Account Setup**  
Enter the NVS-31's account name and password. Click the **Apply** button to save the new settings.

### System Control

**Restore to Default**  
Click this button to restore default settings.

**System Reboot**  
Click this button to reboot the NVS-31.

## File Repair

The system may crash while the recording is in progress. If this happens, your record file may be damaged. To repair a damaged file, go the **File Repair** page to run the file repair process.

1. Open the “**File Repair**” page and click the “**File List**” drop-down menu to select the damaged MP4 file.

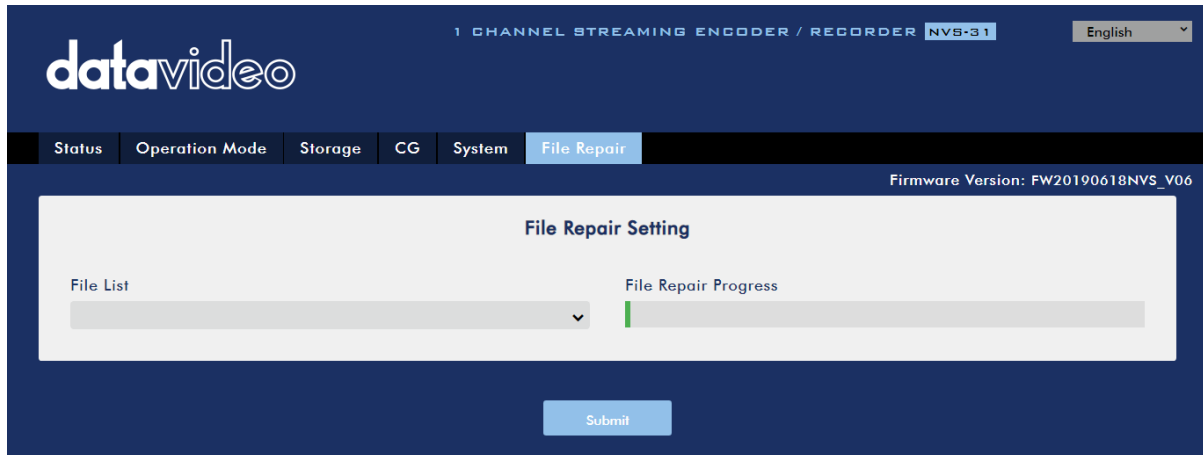

2. If the MP4 file can be repaired, you will see a pop-up dialogue box prompting “**MP4\_FIX\_OK**”, click **OK** then the “**Submit**” button.

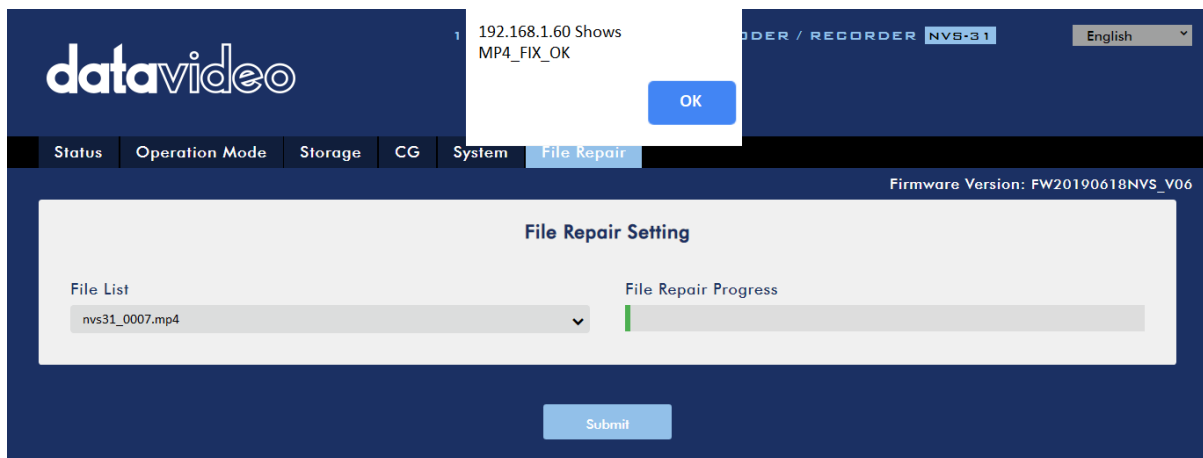

**Note:** If the selected MP4 file cannot be repaired, a dialogue box prompting “**MP4\_FIX\_ERROR\_MDATA**” will pop up.

3. The file is repaired when you see a dialogue box prompting “**File repair finish!!**”. Click OK and reboot the NVS-31.

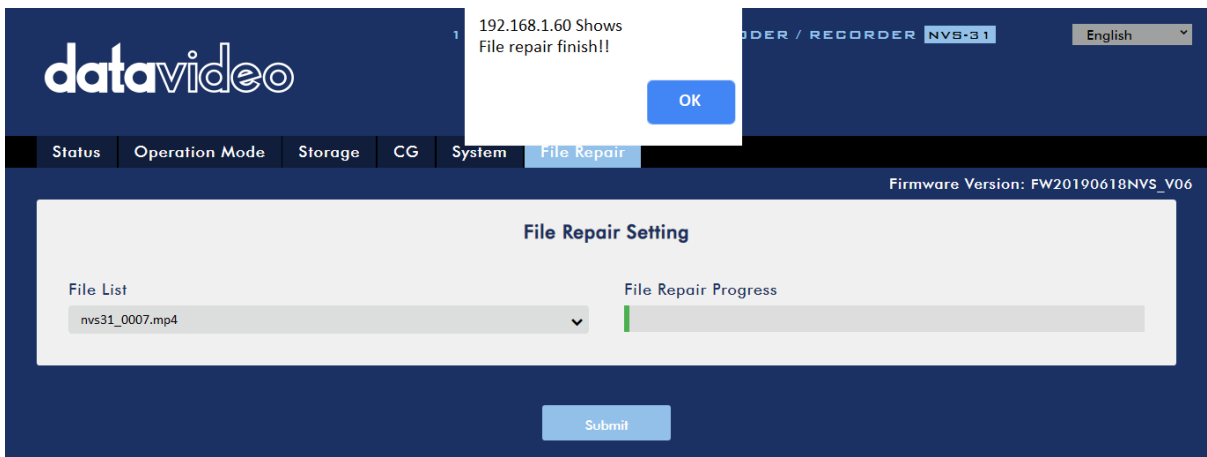

4. After the NVS-31 successfully reboots, you will see the repaired file with the file name of the damaged file appended of the word “new”.

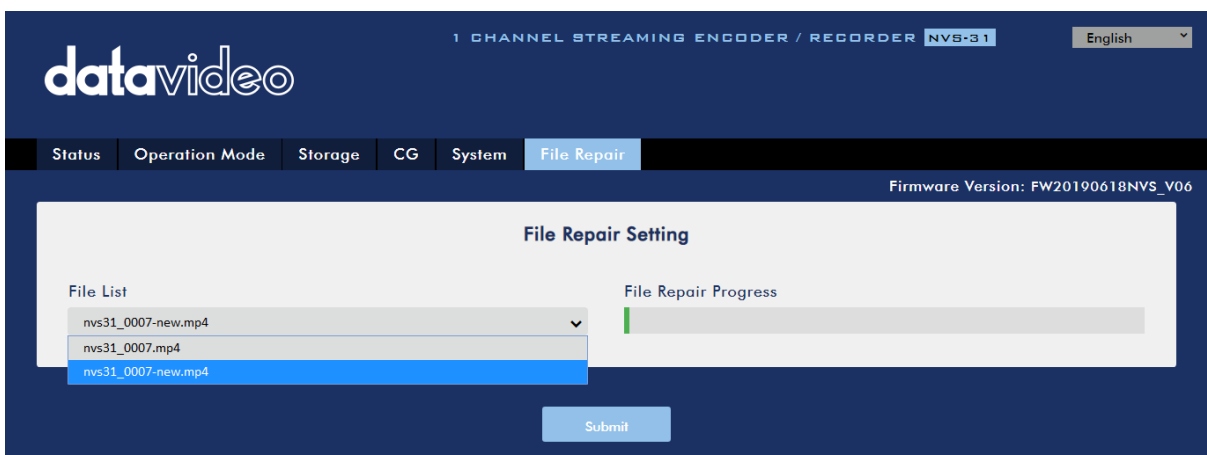

## 7.3 Operations

In this section, we will discuss how you can play the video using different streaming protocols and how to place texts on your video.

### ***Video Streaming***

The NVS-31 provides the user with different video streaming options such as RTSP, TS, RTMP(S), HLS, and SRT.

This section discusses settings of these options and how to stream your video using these methods.

### ***RTSP/TS/HLS/SRT***

In the **RTSP/TS/HLS/SRT** modes, the **NVS-31** is a stream server which allows any client device to connect and playback your video stream. However, if you would like to stream to multiple client devices, we recommend using a separate media server to set up your streaming environment.



The following operation procedure uses VLC media player to playback video stream. If your PC or laptop does not have VLC media player installed, please visit

VideoLAN's official homepage (<https://www.videolan.org/>) and download the installation file then install the program.

**Follow the steps below to obtain the RTSP URL:**

1. Open the stream settings page
2. Select RTSP

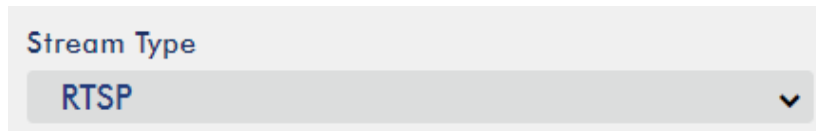

3. Click the **Start** button to generate the RTSP URL.



4. Based on your settings, the device will automatically generate the RTSP URL.

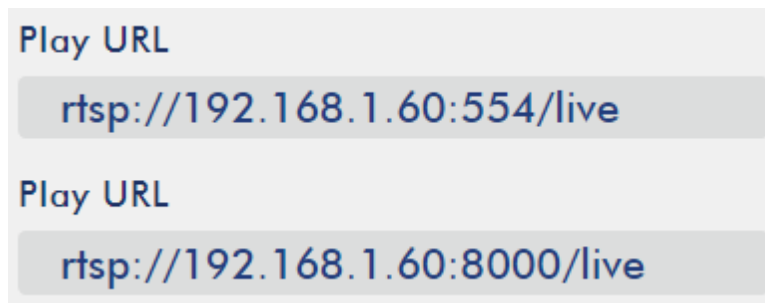

5. Before streaming the video via RTSP, enter the RTSP URL into the client device.
6. Open VLC then click **Open Network Stream** (shown in the diagram below).

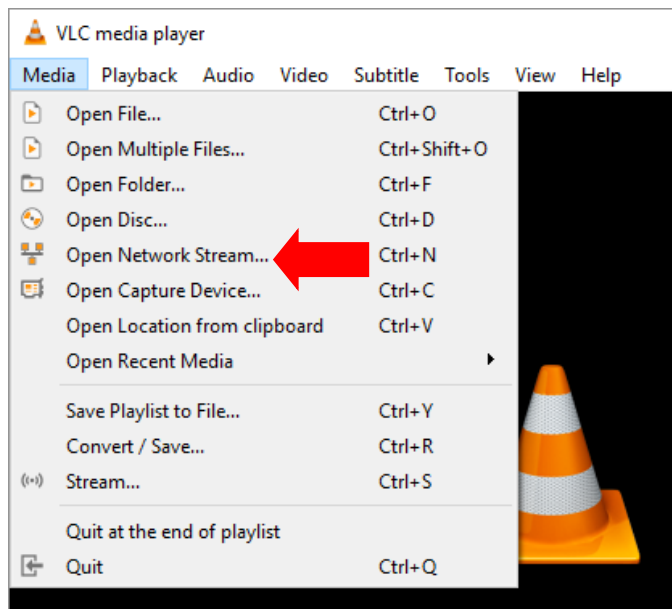

7. As shown in the diagram below, enter the stream URL then click **Play** to start streaming.

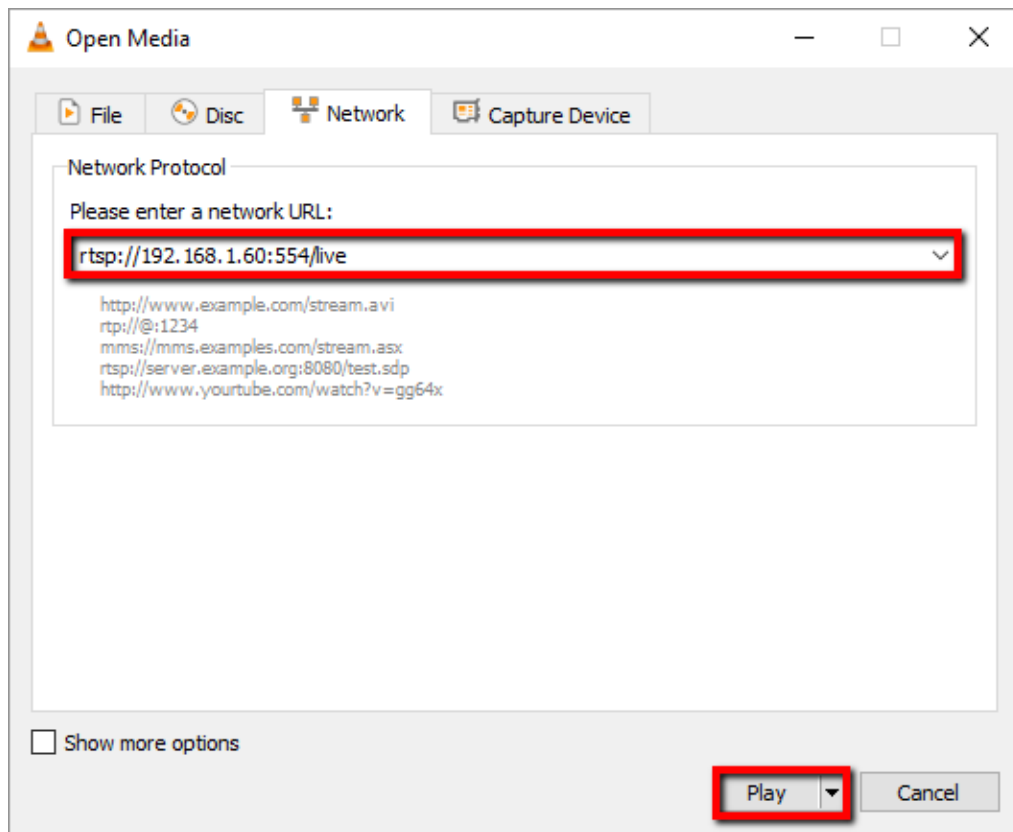

**Follow the steps below to obtain the TS URL:**

1. Open the stream settings page
2. Select TS.



3. Enter the TS port number which is 12345 by default.

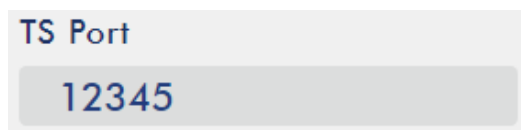

4. In the TS IP field, enter your PC's IP address such as 192.168.1.66.



5. Click the **Start** button to generate the TS URL which, in this example, will be `udp://@192.168.1.66:12345` as shown in the diagram below.



6. Before streaming the video via TS, enter the TS URL into the client device.
7. Open VLC then click **Open Network Stream** (shown in the diagram below).

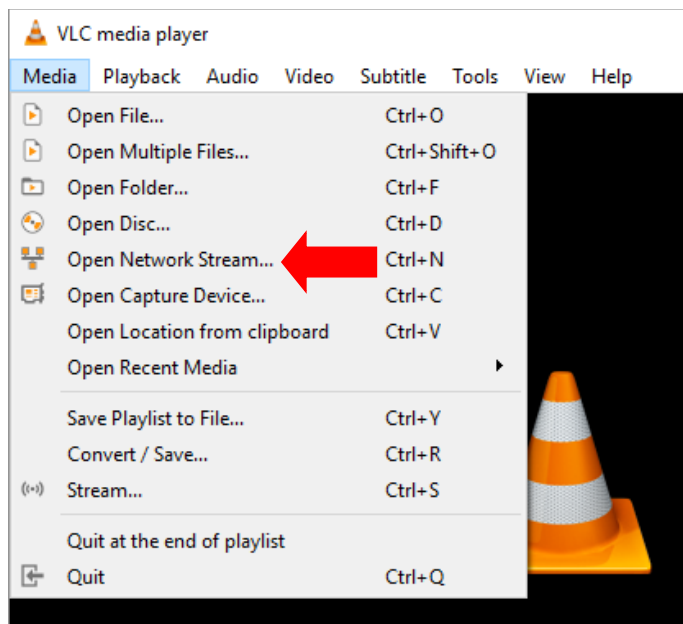

8. As shown in the diagram below, enter the stream URL then click **Play** to start streaming.

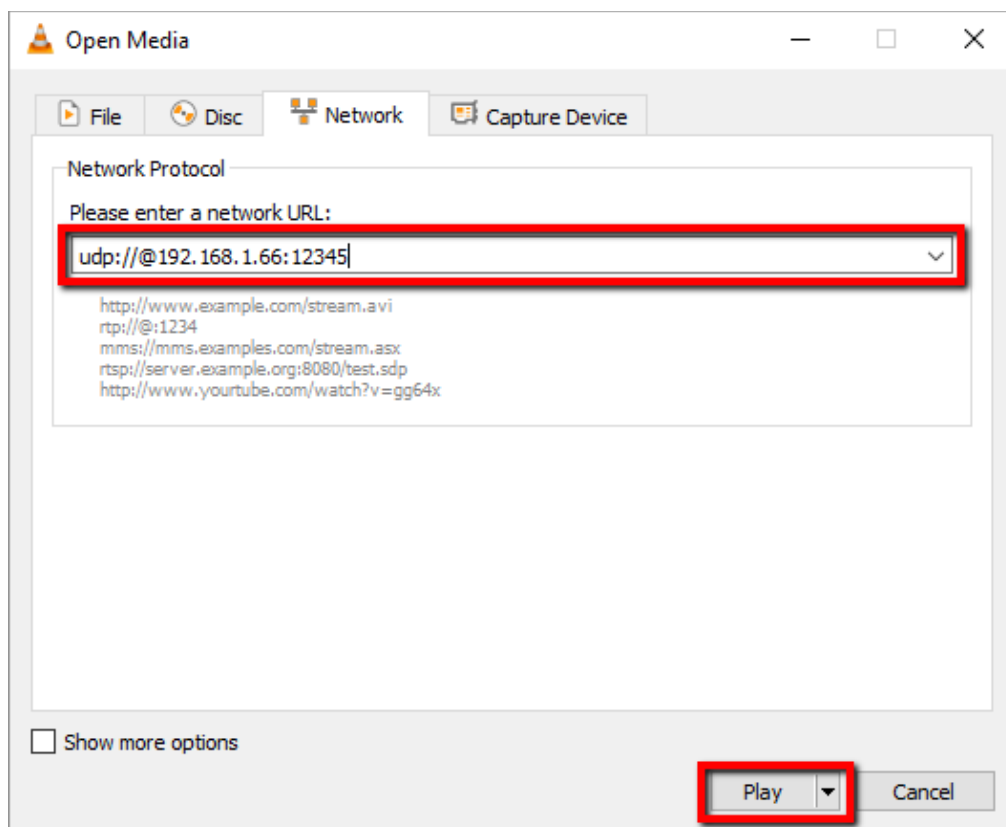

**Follow the steps below to obtain the HLS URL:**

1. Open the stream settings page
2. Select **HLS**

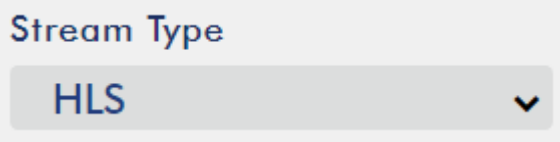

3. Click the **Start** button to generate the HLS URL.



4. Based on your settings, the device will automatically generate a .m3u8 stream URL as shown below.



5. Before streaming the video via **HLS**, enter the **HLS** URL into the client device.
6. Open VLC then click **Open Network Stream** (shown in the diagram below).

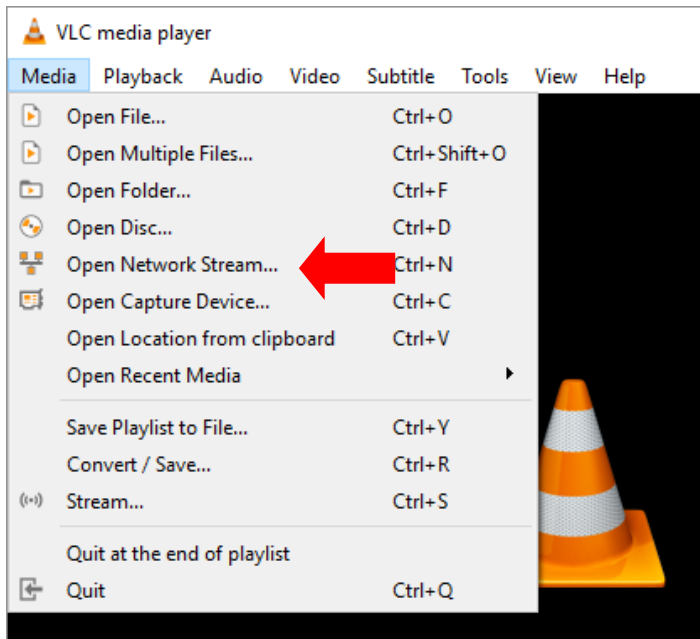

7. As shown in the diagram below, enter the stream URL then click **Play** to start streaming.

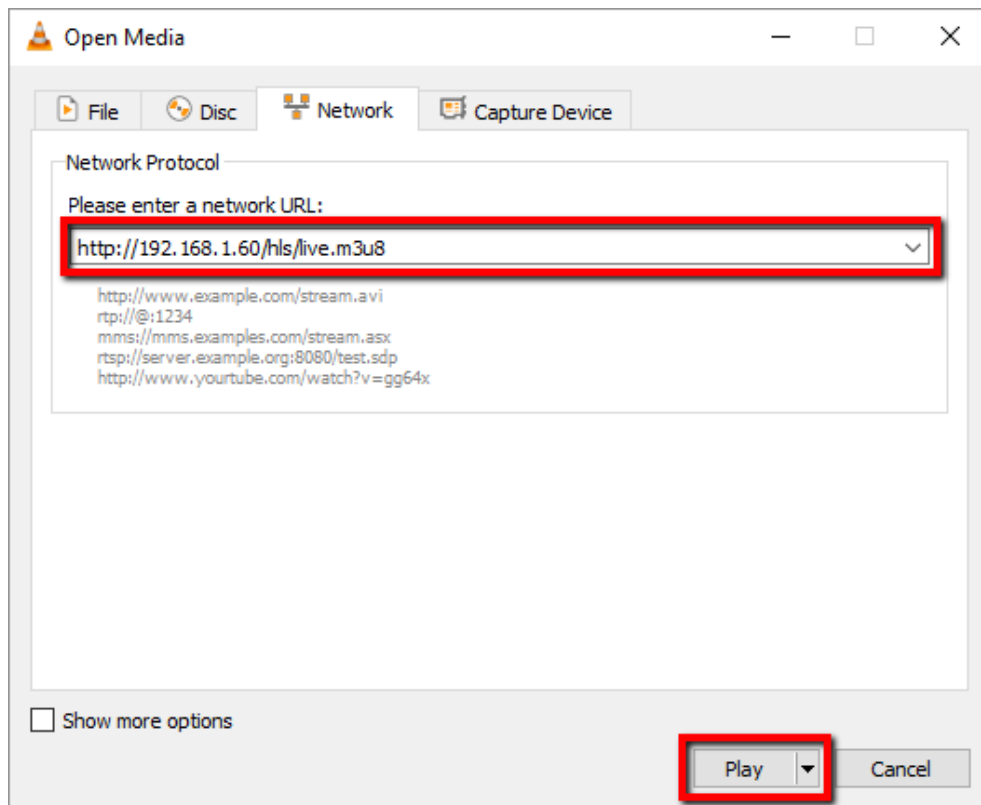

8. You can also play .m3u8 stream URL using the devices listed as follows:
  - iPhone, iPad and MacBook: Use Safari to open the .m3u8 stream URL.
  - Windows 10: Use Microsoft Edge to open the .m3u8 stream URL.

**Follow the steps below to obtain the SRT URL:**

1. Open the stream settings page
2. Select **SRT** and the **SRT port number** is 9001 by default.



3. Click the **Start** button to generate the SRT URL.



4. Before streaming the video via **SRT**, enter the **SRT URL** into the client device.



5. Open VLC then click **Open Network Stream** (shown in the diagram below).



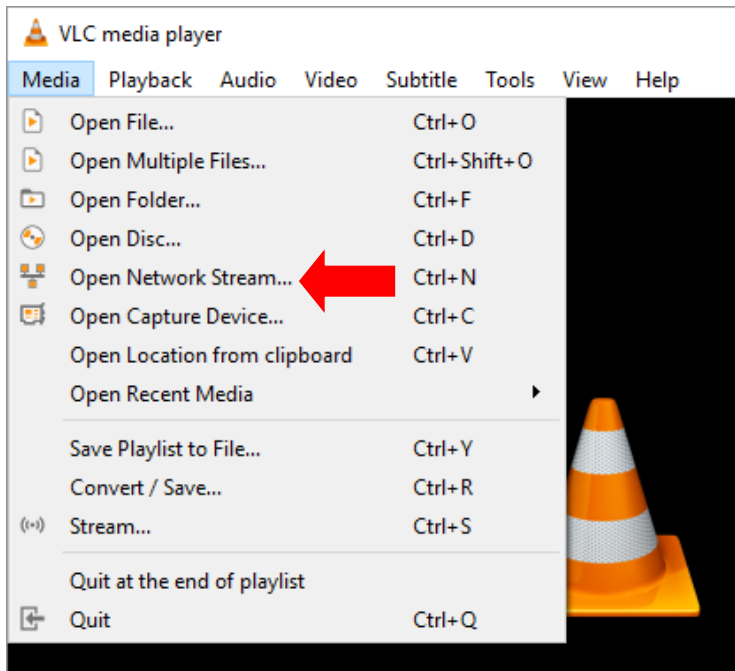

- As shown in the diagram below, enter the stream URL then click **Play** to start streaming.

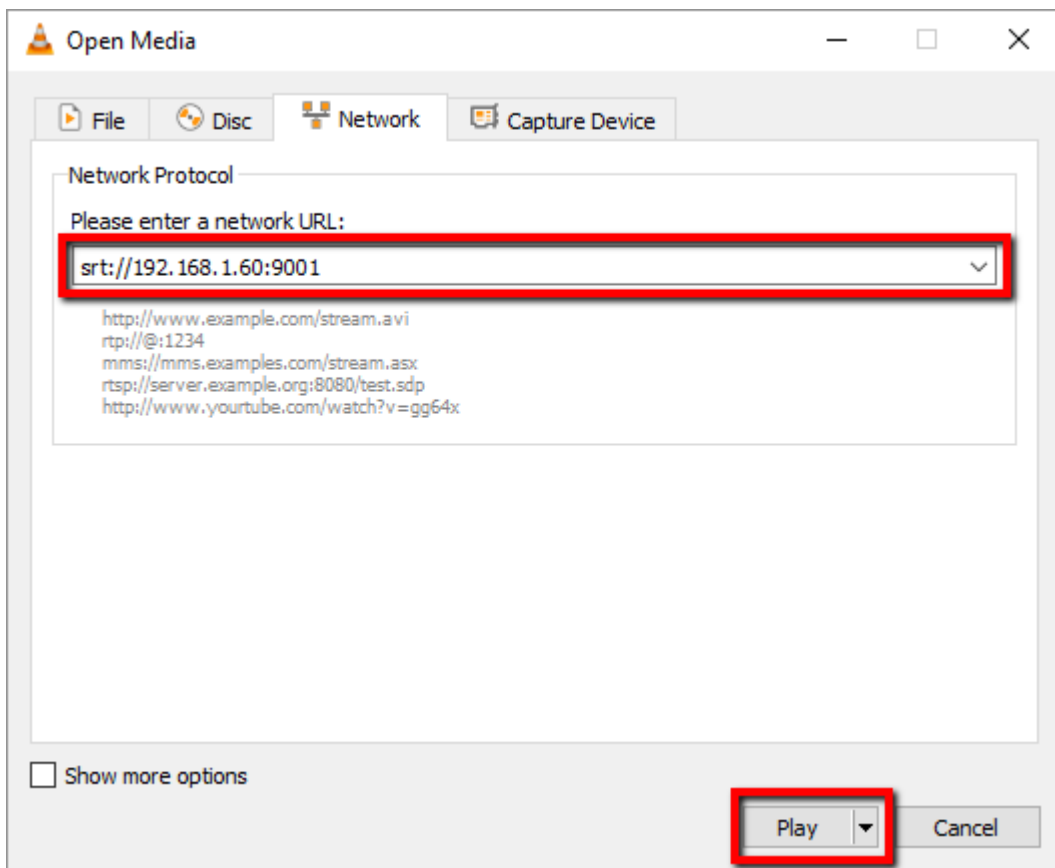

### **RTMP(S)**

In the **RTMP(S)** mode, the NVS-31 can only send one data stream to one CDN or media server that supports the **Real-Time Messaging Protocol** or the **Real-Time Messaging Protocol over an TLS/SSL connection**. Examples of the **RTMP(S)** media server are **USTREAM** and **Youtube**.

**Note: The NVS-31 supports RTMP(S) only and not the RTMP(S) local.**

In the following section, we will show you how to set up an **RTMP(S)** stream to **Youtube**. The step-by-step account setup is outlined as follows:

1. First of all, you have to obtain Server URL and Stream name/key from Youtube.
2. Open the Youtube Live Dashboard [https://www.youtube.com/live\\_dashboard](https://www.youtube.com/live_dashboard)
3. On the left column, locate and click “**Stream now.**”

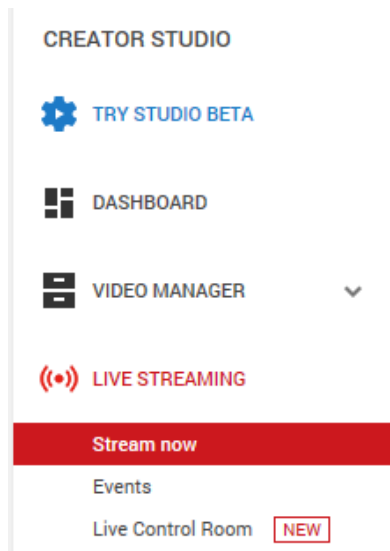

4. On the right, scroll down to the bottom where you will be able to find **Server URL** and **Stream name/key**.

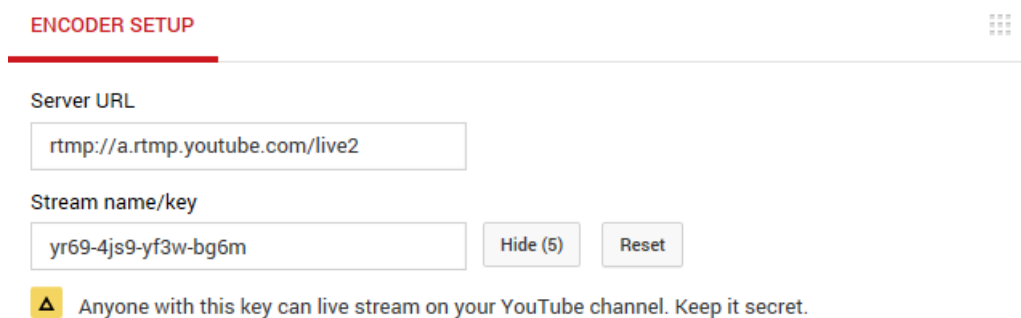

5. On the NVS-31, open the **Stream Only** operation mode page.
6. Select **RTMP** from the Stream Type drop-down menu.



7. Enter the **Server URL (rtmp://a.rtmp.youtube.com/live2)** obtained from the **Youtube Live Streaming** page into the **RTMP URL** field.

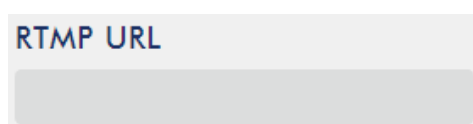

8. Enter the **Stream name/key (yr69-4js9-yf3w-bg6m)** obtained from the **Youtube Live Streaming** page into the **StreamName** field.



A screenshot of a web form with a label 'StreamName' in blue text above a grey rectangular input field.

9. As required by the live streaming channel, enter your Youtube account name and password into the **Account** and **Password** fields.



A screenshot of a web form with two labels, 'Account' and 'Password', in blue text. Below each label is a grey rectangular input field.

10. Click the **Start** button to start streaming the live video on the **Youtube Live Streaming** page. You should also see an **RTMP URL** generated.
11. The **RTMP URL** is another alternative that allows you to view the live stream on a web browser. Enter the **RTMP URL** into the web browser's address bar then hit the **Enter** button to open the live video stream.
12. Click the **Stop Stream** button to stop live streaming.



A blue rectangular button with the word 'Stop' written in white text.

**Tip: You are allowed to stream audio or video only.**

### ***Text Overlay Video***

The HS-3200's built-in video streaming server not only allows you to stream and record your program, it also features a CG tool that is capable of overlaying text on the video currently being broadcast.

The CG settings page is shown below:

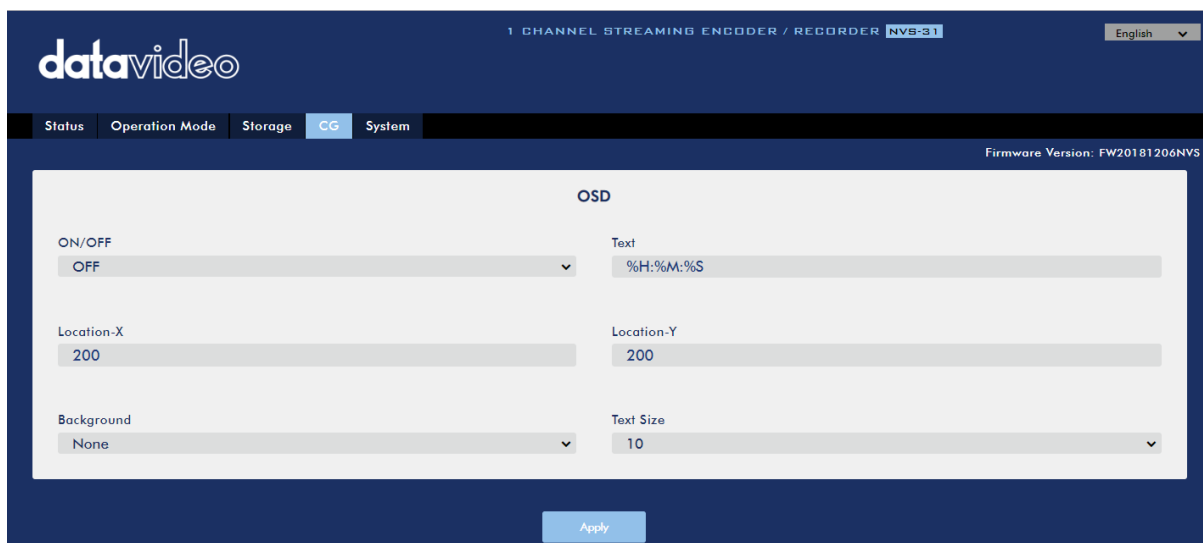

A screenshot of the 'datavideo' web interface. The top navigation bar includes 'Status', 'Operation Mode', 'Storage', 'CG' (highlighted), and 'System'. The main content area is titled 'OSD' and contains several settings: 'ON/OFF' set to 'OFF', 'Text' set to '%H:%M:%S', 'Location-X' set to '200', 'Location-Y' set to '200', 'Background' set to 'None', and 'Text Size' set to '10'. An 'Apply' button is located at the bottom center.

Follow the steps below to overlay text on the video:

1. Open the **CG** settings page.
2. Enable the CG function.
3. In the **Text** field, enter the overlay text.
4. Enter the **X and Y coordinates** to set the text position.
5. Click the **Apply** button to save the new settings.

**Note: Increasing the X coordinate moves the overlay text to the right and decreasing the X coordinate moves the overlay text to the left; increasing the Y coordinate moves the overlay text up and decreasing the Y coordinate moves the overlay text down.**

## 7.4 Stream and Record Buttons

Before you start reading this section, first check the streaming button row located to the right of the SD card slot. If your HS-3200 is a four button model, feel free to skip the two button section.

### *Two Button Model*

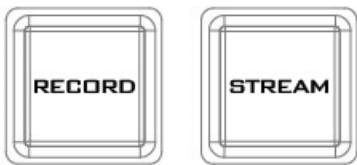

The **RECORD** and **STREAM** buttons on the front panel of the HS-3200 give the user certain controls of the record and stream functions. In this section, we will cover operations of these two buttons in detail.

Button LED behaviors and their corresponding states are listed in the table below:

	<b>RECORD Button</b>	<b>STREAM Button</b>
<b>Solid White</b>	Record function in idle state	Stream function in idle state
<b>Blinking Red</b>	Record function is activating or resetting	Stream function is activating or resetting
<b>Solid Red</b>	Record function activated	Stream function activated

### *Record Button*

Press the **RECORD** button to start/stop recording.

#### **Start recording**

- When idle, the **RECORD** button is solid white.
- Press and hold the **RECORD** button for approximately 2 seconds.
- When the record function is activating, the **RECORD** button turns from solid white, then blinking red and finally to solid red.
- When the **RECORD** button is solid red, this indicates that the record function has been successfully activated.

**Note: The RECORD button is disabled in the Stream Only mode.**

## Stop recording

- While recording, the **RECORD** button is solid red.
- Press and hold the **RECORD** button for approximately 2 seconds.
- When the record function is terminating, the **RECORD** button turns from solid red, then blinking red and finally to solid white.
- When the **RECORD** button is solid white, this indicates that the record function has been successfully terminated.

## Stream Button

Press the **STREAM** button to start/stop streaming.

## Start streaming

- When idle, the **STREAM** button is solid white.
- Press and hold the **STREAM** button for approximately 2 seconds.
- When the stream function is activating, the **STREAM** button turns from solid white, then blinking red and finally to solid red.
- When the **STREAM** button is solid red, this indicates that the record function has been successfully activated.

**Note: The STREAM button is disabled in the Record Only mode.**

## Stop streaming

- While streaming, the **STREAM** button is solid red.
- Press and hold the **STREAM** button for approximately 2 seconds.
- When the stream function is terminating, the **STREAM** button turns from solid red, then blinking red and finally to solid white.
- When the **STREAM** button is solid white, this indicates that the stream function has been successfully terminated.

## Operation Mode

### Checking the NVS-31's operation mode

- First make sure the stream and record functions are in idle state, i.e. **STREAM** and **RECORD** buttons are solid white.
- Press **RECORD** or **STREAM** button.
- The button LED should behave according to the device's operation mode. The LED behaviors are summarized in the table below:

	Solid red RECORD button	Solid white RECORD button
Solid red STREAM button	Stream & Record	Stream Only Mode
Solid white STREAM button	Record Only Mode	None

- The two buttons turn solid white a few seconds after displaying the operation mode.

### Switching operation modes

- First make sure the stream and record functions are in idle state, i.e. **STREAM** and **RECORD** buttons are solid white.
- Simultaneously press and hold the **RECORD** and **STREAM** buttons for more than 3 seconds but less than 10 seconds.
- As the operation mode switches, both the **RECORD** and **STREAM** buttons turn from solid red, then blinking red and finally to solid white.
- When the **RECORD** and **STREAM** buttons turn solid white, it indicates that the NVS-31 has been switched to the next operation mode successfully.

**Note: The order of the operation mode change is Stream & Record → Stream Only → Record Only**

### Checking the next operation mode

If you do not know the NVS-31's current operation mode, follow the steps below to check the next operation mode before switching.

- First make sure the stream and record functions are in idle state, i.e. **STREAM** and **RECORD** buttons are solid white.
- Simultaneously press and hold the **RECORD** and **STREAM** buttons for more than 1 second but less than 3 seconds.
- The button LED should behave according to the device's next operation mode. The LED behaviors are summarized in the table below:

	Solid red RECORD button	Solid white RECORD button
Solid red STREAM button	Stream & Record	Stream Only Mode
Solid white STREAM button	Record Only Mode	None

- The two buttons turn solid white a few seconds after displaying the operation mode.

**Note: The order of the operation mode change is Stream & Record → Stream Only → Record Only**

### Four Button Model

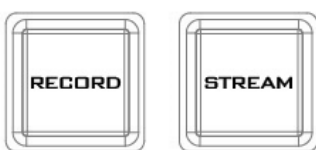

The **RECORD**, **STREAM**, **RECORD+STREAM** and **BITRATE** buttons on the front panel of the HS-3200 give the user certain controls of the record and stream functions. In this section, we will cover operations of these four buttons in detail.

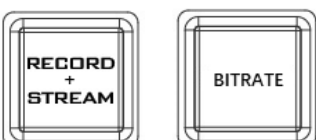

Button LED behaviors and their corresponding states are listed in the table below:

	<b>RECORD Button</b>	<b>STREAM Button</b>	<b>RECORD+STREAM Button</b>
<b>Solid White</b>	Record function in idle state	Stream function in idle state	Record/Stream functions in idle state simultaneously
<b>Blinking Red</b>	Record function is activating or resetting	Stream function is activating or resetting	Record/Stream functions are activating or resetting simultaneously
<b>Solid Red</b>	Record function activated	Stream function activated	Record/Stream functions are activated simultaneously

### ***Record Button***

Press the **RECORD** button to start/stop recording.

#### **Start recording**

- When idle, the **RECORD** button is solid white.
- Press and hold the **RECORD** button for approximately 2 seconds.
- When the record function is activating, the **RECORD** button turns from solid white, then blinking red and finally to solid red.
- When the **RECORD** button is solid red, this indicates that the record function has been successfully activated.

**Note: The RECORD button is disabled in the Stream Only mode.**

#### **Stop recording**

- While recording, the **RECORD** button is solid red.
- Press and hold the **RECORD** button for approximately 2 seconds.
- When the record function is terminating, the **RECORD** button turns from solid red, then blinking red and finally to solid white.
- When the **RECORD** button is solid white, this indicates that the record function has been successfully terminated.

### ***Stream Button***

Press the **STREAM** button to start/stop streaming.

#### **Start streaming**

- When idle, the **STREAM** button is solid white.
- Press and hold the **STREAM** button for approximately 2 seconds.
- When the stream function is activating, the **STREAM** button turns from solid white, then blinking red and finally to solid red.
- When the **STREAM** button is solid red, this indicates that the record function has been successfully activated.

**Note: The STREAM button is disabled in the Record Only mode.**

## Stop streaming

- While streaming, the **STREAM** button is solid red.
- Press and hold the **STREAM** button for approximately 2 seconds.
- When the stream function is terminating, the **STREAM** button turns from solid red, then blinking red and finally to solid white.
- When the **STREAM** button is solid white, this indicates that the stream function has been successfully terminated.

## *Record+Stream Button*

### Start recording/streaming simultaneously

- When idle, the **RECORD+STREAM** button is solid white.
- Press and hold the **RECORD+STREAM** button for approximately 2 seconds.
- When the record and stream functions are activating simultaneously, the **RECORD+STREAM** button turns from solid white, then blinking red and finally to solid red.
- When the **RECORD+STREAM** button is solid red, this indicates that the record and stream functions have been successfully activated.

### Stop recording/streaming simultaneously

- While recording and streaming simultaneously, the **RECORD+STREAM** button is solid red.
- Press and hold the **RECORD+STREAM** button for approximately 2 seconds.
- When the record and stream functions are terminating, the **RECORD+STREAM** button turns from solid red, then blinking red and finally to solid white.
- When the **RECORD+STREAM** button is solid white, this indicates that the record and stream functions have been successfully terminated.

## *Bitrate Button*

Follow the steps below to switch the stream bitrate mode using the **BITRATE** button:

- Press and hold one of the **RECORD+STREAM** button, the **RECORD** button, and the **STREAM** button until the pressed button starts blinking red.
- Continue holding down one of the **RECORD+STREAM** button, the **RECORD** button, and the **STREAM** button while pressing the **BITRATE** button to switch stream bitrate mode (H, M or L).

**Note: The system will return to original settings if the BITRATE button push is not sensed. The default bitrate is M.**

## *Operation Mode*

### Checking the NVS-31's operation mode

Follow the steps below to check the NVS-31's current operation mode:



- First make sure the stream and record functions are in idle state, i.e. **STREAM** and **RECORD** buttons are solid white.
- Press **RECORD** or **STREAM** button.
- The button LED should behave according to the device's operation mode. The LED behaviors are summarized in the table below:

	Solid red RECORD button	Solid white RECORD button
Solid red STREAM button	Stream & Record	Stream Only Mode
Solid white STREAM button	Record Only Mode	None

- The two buttons turn solid white a few seconds after displaying the operation mode.

### Switching operation modes

Follow the steps below to switch to the next operation mode:

- First make sure the stream and record functions are in idle state, i.e. **STREAM** and **RECORD** buttons are solid white.
- Simultaneously press and hold the **RECORD** and **STREAM** buttons for more than 3 seconds but less than 10 seconds.
- As the operation mode switches, both the **RECORD** and **STREAM** buttons turn from solid red, then blinking red and finally to solid white.
- When the **RECORD** and **STREAM** buttons turn solid white, it indicates that the NVS-31 has been switched to the next operation mode successfully.

**Note: The order of the operation mode change is Stream & Record → Stream Only → Record Only**

### Checking the next operation mode

Follow the steps below to check the operation mode next to the NVS-31's current operation mode before switching:

- First make sure the stream and record functions are in idle state, i.e. **STREAM** and **RECORD** buttons are solid white.
- Simultaneously press and hold the **RECORD** and **STREAM** buttons for more than 1 second but less than 3 seconds.
- The button LED should behave according to the device's next operation mode. The LED behaviors are summarized in the table below:

	Solid red RECORD button	Solid white RECORD button
Solid red STREAM button	Stream & Record	Stream Only Mode
Solid white STREAM button	Record Only Mode	None

- The two buttons turn solid white a few seconds after displaying the operation mode.

**Note: The order of the operation mode change is Stream & Record → Stream Only → Record Only**

## 7.5 Restoring Factory Defaults

Follow the steps below to restore the NVS-31's factory defaults.

- The **RECORD** and **STREAM** buttons are either solid white and solid red, which means the factory defaults can be restored regardless of the state of the device.
- Press and hold the **RECORD** and **STREAM** buttons simultaneously for more than 10 seconds.
- While the NVS-31's factory defaults are being restored, both the **RECORD** and **STREAM** buttons turn from solid red, then blinking red and finally to solid white.
- When the **RECORD** and **STREAM** buttons turn solid white, it indicates that the NVS-31's factory defaults have been successfully restored.

## 7.6 Firmware Update

Datavideo usually releases new firmware containing new features or reported bug fixes from time to time. This section outlines the firmware upgrade process which should take *approximately 10 minutes to complete*. See [Appendix 4](#) for instructions.

## Chapter 8 Monitor OSD MENU



The HS-3200 Monitor can be configured via an on screen menu. When the **MENU** button is pressed the Main Menu list is displayed on the monitor.

This section covers the Menu options in the order that they appear on the monitor. These settings may also appear in more detail elsewhere in this instruction manual. Options may vary depending on the firmware version in use.

Once the chosen setting has been confirmed with the **ENTER** button, it is stored within the switcher's non-volatile memory.

Main Options	Sub Options	Parameters	Parameters
MAIN ADJUST	BRIGHTNESS	0~100	
	CONTRAST	0~100	
	SHARPNESS	0~100	
	SATURATION	0~100	
	TINT	0~100	
	BACK LIGHT	0~100	
	NR	HIGH / MID / LOW / OFF	
	MPEG NR	HIGH / LOW / OFF	
	VOLUME	0~100	
	EXIT		
COLOR	6500		
	9300		
	7500		
	USER COLOR	RED	0~100
		GREEN	0~100
		BLUE	0~100
EXIT			
SCAN SETTING	UNDER SCAN	full image	
	OVER SCAN	cropped image	
INFORMATION	H. FREQUENCY		
	V. FREQUENCY		
	RESOLUTION		
	VER.		
LANGUAGE	English [default]		
	Francis		
	Deutsch		
	Español		
	Italiano		
	Dutch		
	Português		
	Russian		
EXIT			
SPECIAL FUNCTION	OSD TIMOUT	5-120 SEC	
	FRAME RATIO	80 / 90 / OFF	

	<b>4:3 MARK LINE</b>	ON / OFF	
	<b>CENTRAL MARK</b>	ON / OFF	
	<b>CINEMA ZONE MARK</b>	ON / OFF	
	<b>EXIT</b>		
<b>FACTORY RESET</b>			
<b>EXIT</b>			

## 8.1 Main Adjust

The first menu option is the **MAIN ADJUST**.

To access the MAIN ADJUST sub-menu, press enter and the Brightness sub-option will be highlighted.

To adjust **BRIGHTNESS** press Enter again. Use the Up / Down buttons to change the setting and then press Enter to store the new value and return to the main menu.

Use the Up / Down buttons to select a different setting (Brightness, Contrast, Saturation, Sharpness, TINT and etc). Follow the same procedure to set other values.

## 8.2 Color

Press the MENU button to access the menu and use the Up / Down buttons to move to the **COLOR** option so that it is highlighted. Press the **ENTER** button to open the COLOR sub-menu.

To access the selected color setting, press **ENTER** again.

Use the Up / Down buttons to navigate the available color settings.

- 7500
- 9300
- 6500
- USER COLOR

## 8.3 Information

The **System Information** Menu displays Horizontal Frequency, Vertical Frequency, Resolution and the monitor's version of firmware.

Once selected, the information will be displayed as follows:

- **H. FREQUENCY**            33.7KHZ
- **V. FREQUENCY**            60.0HZ
- **RESOLUTION**                1920X1080I
- **VER.**                            0.11

## 8.4 Special Function

The Special Function Sub-Menu has settings for the **OSD TIMEOUT**, **Frame Ratio**, **4:3 MARK LINE**, **Central Mark**, and **Cinema Zone Mark**.

To access the selected setting press the **ENTER** button.

Use the Up / Down buttons to navigate the available options.

- **OSD TIMEOUT**                      5-120 SEC
- **FRAME RATIO**                      90 / 80 / OFF
- **4:3 MARK LINE**                    ON / OFF
- **CENTRAL MARK**                    ON / OFF
- **CINEMA ZONE MARK**              ON / OFF

## 8.5 Factory Reset

The monitor menu offers a Factory Reset option, which will return all the settings of the monitor to the factory defaults

To reset the monitor press the MENU button and then use the UP / Down button to navigate to **FACTORY RESET** option. Press **ENTER** again to reset the monitor. After a few seconds the monitor will be reset.

## Chapter 9 Appendices

### Appendix 1 Tally Outputs

The HS-3200 has a D-sub 25 pin female tally output port. These connections provide bi-colour tally information to a number of other Datavideo products, such as the ITC-100 eight channel talkback system and the TLM range of LCD Monitors.

These ports are open collector ports and as such do not provide power to tally light circuits.

Dielectric strength: Max. DC 24V

Current: Max. 50mA

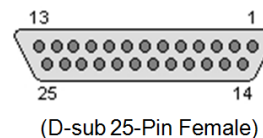

The pin outputs are defined as follows:

Pin No.	Signal name	Input/Output	Signal Description
1	Program 1	Open collector output	Tally output of input video Program 1
2	Program 2	Open collector output	Tally output of input video Program 2
3	Program 3	Open collector output	Tally output of input video Program 3
4	Program 4	Open collector output	Tally output of input video Program 4
5	Program 5	Open collector output	Tally output of input video Program 5
6	Program 6	Open collector output	Tally output of input video Program 6
7	Program 7	Open collector output	Tally output of input video Program 7
8	Program 8	Open collector output	Tally output of input video Program 8
9	Program 9	Open collector output	Tally output of input video Program 9
10	Program 10	Open collector output	Tally output of input video Program 10
11	Program 11	Open collector output	Tally output of input video Program 11
12	Program 12	Open collector output	Tally output of input video Program 12
13	GND	Ground	Ground
14	Preset 1	Open collector output	Tally output of input video Preset 1
15	Preset 2	Open collector output	Tally output of input video Preset 2
16	Preset 3	Open collector output	Tally output of input video Preset 3
17	Preset 4	Open collector output	Tally output of input video Preset 4
18	Preset 5	Open collector output	Tally output of input video Preset 5
19	Preset 6	Open collector output	Tally output of input video Preset 6
20	Preset 7	Open collector output	Tally output of input video Preset 7
21	Preset 8	Open collector output	Tally output of input video Preset 8
22	Preset 9	Open collector output	Tally output of input video Preset 9
23	Preset 10	Open collector output	Tally output of input video Preset 10
24	Preset 11	Open collector output	Tally output of input video Preset 11
25	Preset 12	Open collector output	Tally output of input video Preset 12

### Example of tally connections

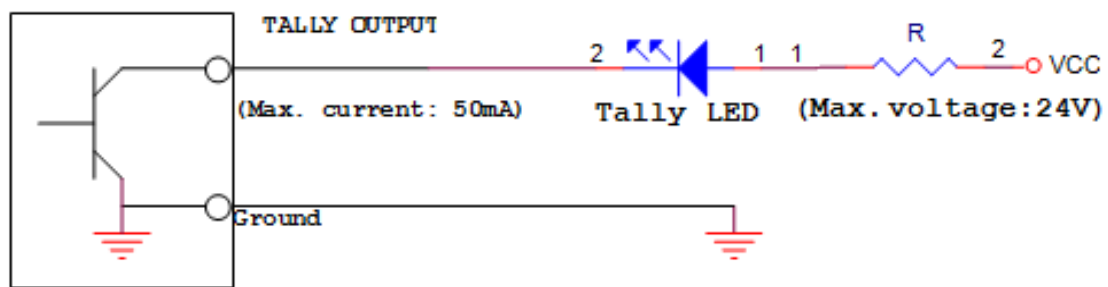

## Appendix 2      GPI / GPO Connections

The HS-3200 can control external recorder/playback devices like the HDR-45 and HDR-55 via a simple contact closure GPI / GPO switch.

The GPI interface is a 3.5mm Jack Socket which is situated on the rear panel of the HS-3200. Contact closure between the Outer and Inner contacts on the jack plug will trigger a user selected event. Power is supplied by the HS-3200 and is less than 5V DC.

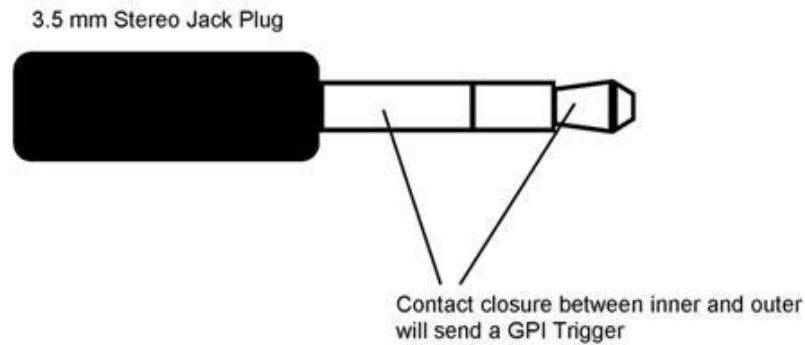

This GPI socket can also be used as a GPO socket to trigger record or playback events with other equipment such as the Datavideo HDR-70 recorder.

**SAFETY FIRST** The cabling required needs to be designed specifically to connect the HS-3200 to the chosen record or playback device as they are not all the same. The cabling required can be made by yourself or a competent technician. Please speak with your Dealer or local Datavideo office to get further help and advice.



## Appendix 3 Recommended SD Cards

You should only use Class 10 SD card or above. In this appendix, you will find a list of SD cards recommended by Datavideo.

Recommended SD Cards			
No.	Brand	Model	Pictures
1	Kingston	SDHC I C10 16GB	
2	SANDISK Extreme	SDXC I C10 U3 V30 64GB	
3	SONY	SDXC I C10 U1 64GB	
4	SANDISK Extreme PRO	SDXC I C10 U3 128GB/64GB	 
5	SONY	SDXC I C10 U3 64GB	
6	TOSHIBA	SDHC C10 16GB	

7	<b>SANDISK Extreme</b>	SDHC C10 16GB	
8	<b>ADATA Premier Pro</b>	microSDXC I UHS-I U3 Class 10 with SD adapter 64GB/16GB	 
9	<b>SANDISK ULTRA®</b>	SDHC™/SDXC™ UHS-I 128GB	
10	<b>Transcend</b>	300S UHS-I SDHC 64GB/32GB	 

## Appendix 4      Firmware Update

Datavideo usually releases new firmware containing new features or reported bug fixes from time to time. Customers can either download the HS-3200 firmware as they wish or contact their local dealer or reseller for assistance.

This section outlines the firmware upgrade process which should take ***approximately 1 hour 20 minutes to complete***.

**The existing HS-3200 settings should persist through the *firmware upgrade process, which should not be interrupted once started* as this could result in a non-responsive unit.**

### ***Switcher***

**Successful firmware upgrade on HS-3200 requires:**

- PC or laptop
- USB drive
- Access to the Internet for software download

**Steps to update the HS-3200 firmware:**

1. Download the latest firmware and the update tool from the path below.

[www.datavideo.com](http://www.datavideo.com) → products → Switchers → HS-3200 → Downloads → Latest Firmware

2. Decompress the downloaded files.
3. Insert the USB drive into the PC or laptop and format the drive to FAT or FAT32 system. Save the latest firmware on the drive.
4. Remove the USB drive from the PC or laptop.
5. Insert the USB drive into the **F/W Upgrade** port at the rear of the HS-3200 switcher.
6. Press the **MENU** button on the HS-3200 control panel to open the OSD menu.
7. At the bottom of the **Main Menu**, enter the **SETUP** sub menu.
8. Under the **Software** option, select “**Upgrade**” and press the **ENTER** button to confirm.
9. If you see “**Upgrade**” against a red background, it means the switcher is being updated.
10. When you see red turned to green, it means the firmware upgrade is successful.
11. Reboot the HS-3200 switcher to complete the upgrade.

## Video Streaming Server

You should first visit the official product page <https://www.datavideo.com/tw/product/HS-3200> where you can download the latest firmware file. Then follow the steps outlined below to update the device firmware.

1. Login the NVS-31 web interface, then click the **System** tab to open the system configuration page.
2. Scroll down to **Firmware Update** then click the **Browse** button to search for the latest firmware file on the PC's hard disk.

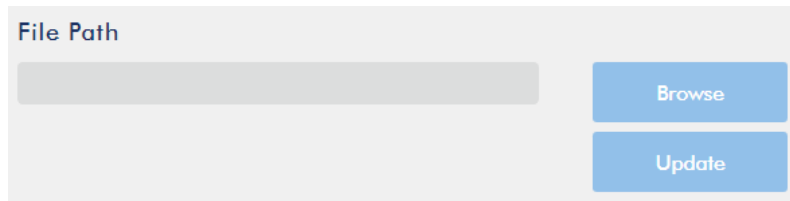

The screenshot shows a web interface for firmware updates. It features a text input field labeled 'File Path' on the left. To the right of the input field are two blue buttons: 'Browse' (top) and 'Update' (bottom).

3. After double clicking the firmware file, you will see the loading prompt as shown below, indicating that the file is being uploaded to the NVS-31.

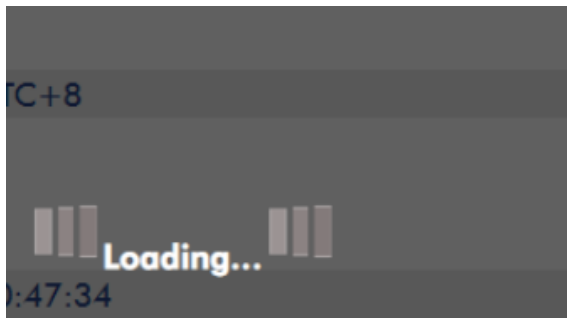

4. After the file has been successfully uploaded, you will see a file upload success message. Click the **Update** button to start the firmware update process.



5. The device will reboot itself after it is updated successfully.

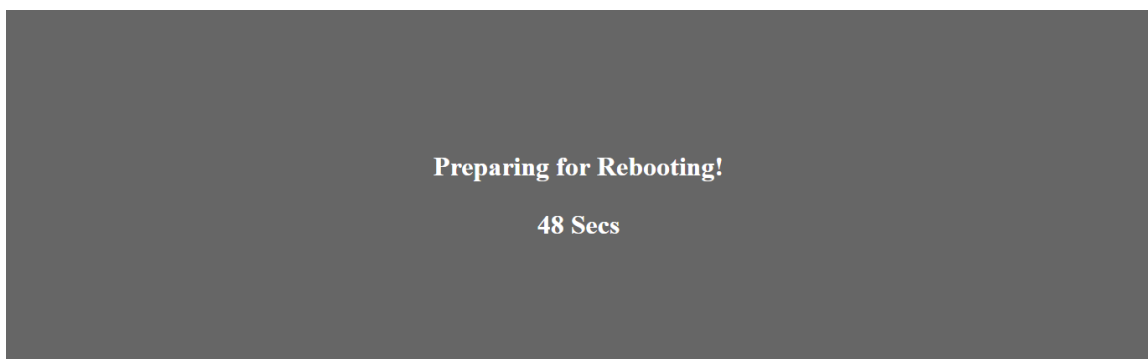

**Note:** If the device is recording or streaming, you must turn them off before initiating the firmware update.

### **Recovery Mode**

If power outage is experienced while the firmware is being updated and the NVS-31 becomes inaccessible due to incomplete update or corrupt files, you may reboot the HS-3200 then activate the recovery mode to restore the device functionality. Follow the steps below to enter the recovery mode.

- Reboot the HS-3200
- As the HS-3200 boots, the **STREAM** button turns solid red then press and hold the **RECORD** and **STREAM** buttons simultaneously; release them when the two buttons start flashing red color.
- The NVS-31 starts erasing files of the previous update and uses the previously uploaded file to force the firmware update.
- When the **RECORD** and **STREAM** buttons turn solid white, the firmware update is complete.

### **Formatting the SD Card**

You are also allowed to format the SD card on the HS-3200. Follow the steps below to format your SD card.

- Insert the SD card into the HS-3200's SD card slot.
- Login the NVS-31 web interface then click the **Storage** tab to open the storage interface.
- Select the disk storage format from the **Storage Format** drop-down list.

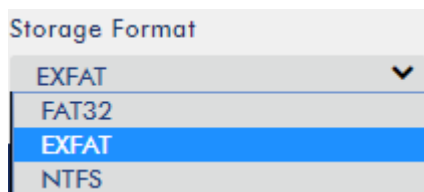

- Click the **Format Storage Disk** button to start SD card formatting. The format is complete when the progress bar reaches 100%.

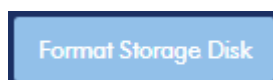

## Appendix 5 Frequently-Asked Questions

This section describes problems that you may encounter while using the HS-3200. If you have any questions, please refer to related sections and follow all suggested solutions. If problem still exists, please contact your distributor or the service center.

No.	Problems	Solutions
1	<b>Grabbed picture is distorted or contains noise.</b>	Successfully grabbed pictures to Still 1 and 2 will be distorted or appear noisy if switched to different video standards.
2	<b>Loaded still picture contains noise.</b>	Still pictures will be distorted or appear noisy if switched to different video standards.
3	<b>What kind of files can be saved on the HS-3200 and is there any limitation?</b>	You can save still pictures, user memory, clips and logos to the HS-3200's memory but the maximum storage space is limited to 1000 frames.
4	<b>One of the FLEX sources is not displayed in the FLEX windows.</b>	The maximum <b>Flex</b> <sup>TM</sup> output size is 1080p full screen. If exceeded, one Flex source will not be displayed.
5	<b>HS-3200 is unable to save the last settings into its nonvolatile memory.</b>	The Last Memory feature will be enabled upon entering and exiting the OSD menu. Only shut down the machine after 10 seconds after the OSD menu is closed (It takes 10 seconds for the HS-3200 to finish saving the last settings to the memory).
6	<b>Why am I seeing black thin lines on PIP images?</b>	These black thin lines are caused by using an image that differs from its original size. To remove these black thin lines, turn the border OFF or use the <a href="#">PIP Crop</a> function to shrink the image until they disappear.

# Appendix 6      Dimensions

## Main Unit

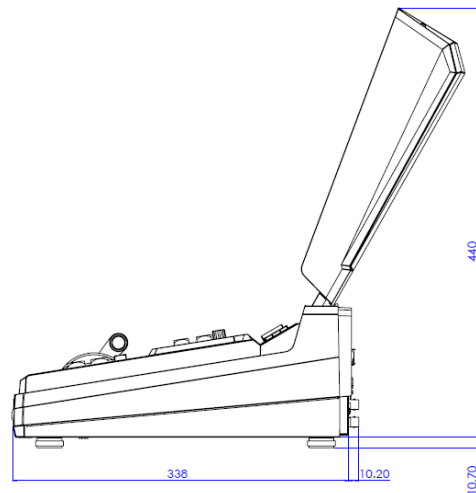
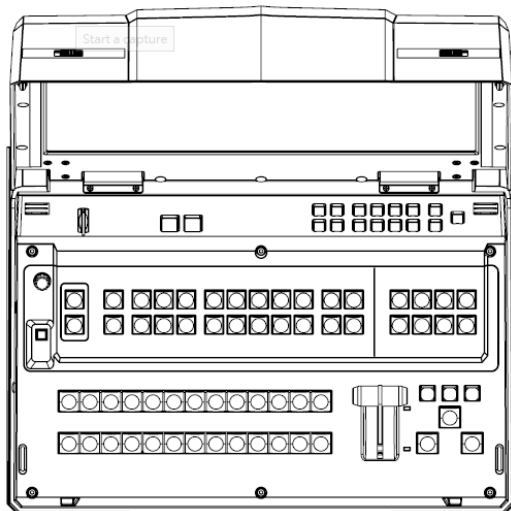
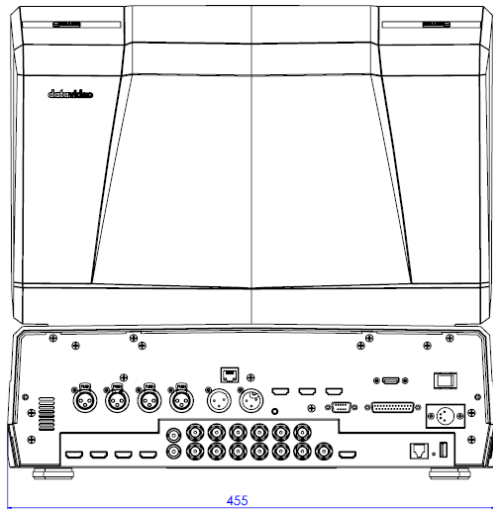

## Appendix 7 Specifications

<b>Model Name</b>	<b>HS-3200</b>
<b>Product Name</b>	<b>HD 12-Channel Digital Video Switcher</b>
<b>Video Standard</b>	Full HD
<b>Video Format</b>	1080p 50/59.94/60Hz 1080i 50/59.94/60Hz 720p 50/59.94/60Hz
<b>Input Routable / Crosspoint</b>	All 12, repeatable
<b>Video Input</b>	8 x SDI 4 x HDMI
<b>Computer Graphical Interface</b>	4 via HDMI
<b>Down-Converted Output</b>	1 x SDI
<b>Video Output</b>	5 x SDI, 1 x HDMI assignable: <ul style="list-style-type: none"> <li>• Multiview</li> <li>• PGM</li> <li>• PVW</li> <li>• PGM+DSK</li> <li>• Clean PGM</li> <li>• Clean PVW</li> <li>• Input 1-12</li> <li>• STILL 1</li> <li>• STILL 2</li> <li>• Flex source</li> </ul> 3 x HDMI PGM only
<b>Analogue Audio Input</b>	4 x Balanced XLR
<b>Analogue Audio Output</b>	2 x Balanced XLR
<b>Digital Embedded Audio Support Input</b>	Input 2 Channels Output 4 Channels
<b>Audio Delay Calibration</b>	up to 16 frames
<b>A+V Switching</b>	Yes
<b>USK</b>	4
<b>DSK</b>	2 x DSK supporting Lumakey & Linear key (Key / Fill)
<b>Picture in Picture</b>	8 (4 x Keyer / 4 x Flex Source)
<b>Logo Insertion</b>	2



<b>Title Creator</b>	Yes, CG-200 software free download
<b>Built-in Monitor Display</b>	17.3" HD TFT LED Backlit, 1920x1080 pix
<b>Streaming Video Encode</b>	H.264 / AVC, Main/High Profile Configurable Bitrate up to 10Mbps
<b>Streaming Audio Encode</b>	AAC-LC Configurable bitrate range from 32 Kbps to 384 Kbps Sample Rate: 48 kHz, 16 bit
<b>Streaming Protocol</b>	TS over TCP/UDP (Unicast & Multicast) RTSP over HTTP/TCP/UDP RTMP/RTMPS (Publish) HLS SRT
<b>Streaming Control</b>	Web browser UI for configuration and control socket commands
<b>Recording File System</b>	FAT, exFAT, NTFS
<b>Recording File Format</b>	MP4
<b>Streaming &amp; Recording Setting Control</b>	Web UI for system configuration and control
<b>Special Features</b>	4 Chroma-Key Virtual Studio 9 Stinger transition and 4 user presets Built-in TC-200 CG interface Streaming encoder and recorder 12x9 matrix seamless switch
<b>Dimensions (LxWxH)</b>	455 x 355 x 134 mm
<b>Weight</b>	17.8 Lbs (8.1 kg), Reinforced Plastic Case
<b>Power</b>	DC 12V, 11A
<b>Operating Temperature</b>	0 – 40°C
<b>Accessory</b>	TPC-700, CB-22H/23H/46/47/60/61/62

## Notes

---

## Notes

---

## Service & Support

It is our goal to make owning and using Datavideo products a satisfying experience. Our support staff is available to assist you to set up and operate your system. Contact your local office for specific support requests. Plus, please visit [www.datavideo.com](http://www.datavideo.com) to access our FAQ section.



Please visit our website for latest manual update.

[www.datavideo.com.tw/product/HS-3200](http://www.datavideo.com.tw/product/HS-3200)

**datavideo**  
[www.datavideo.com](http://www.datavideo.com)



@DatavideoUSA @DatavideoIndia2016  
@DatavideoEMEA @Datavideojapan  
@DatavideoTaiwan @DatavideoLatam  
@DatavideoAsia @DatavideoBrasil



@Datavideo  
@Datavideo\_EMEA  
@Datavideo\_Taiwan



@DatavideoUSA  
@DVTWDCN



@DatavideoUSA  
@DatavideoEurope

All the trademarks are the properties of their respective owners.  
Datavideo Technologies Co., Ltd. All rights reserved 2020

Aug-20.2021  
Version E16